

Dining Table Assembly Instructions

Dining table frame and glass tops will be shipped in two separate boxes. Please take precaution when dealing with glass and sharp objects.

Parts Included:

- 1 - Table Top Frame
- 3 - Glass Top
- 4 - Table Leg
- 16 - Washer & Screw
- 1 - Allen Wrench

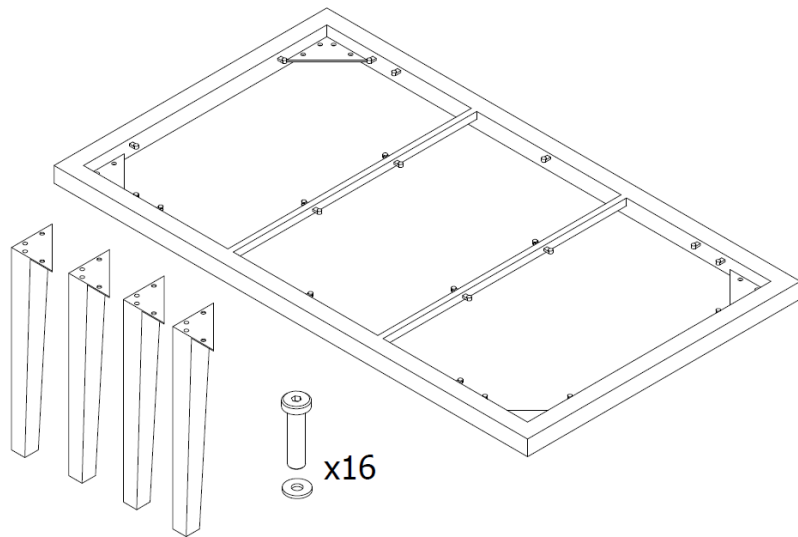

1. Invert table top frame to the upright position with weaved wicker showing on top.



Top side of frame

2. Align table leg to the corner plate of the table top frame. Place washers and tighten the screws using the provided Allen wrench.

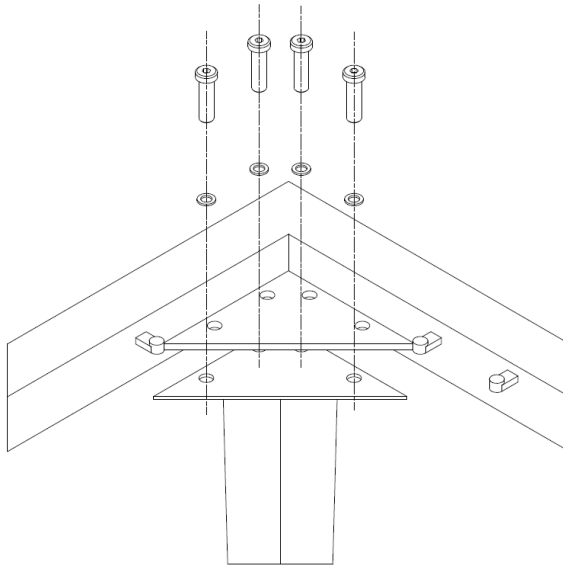

3. Place glass top into the allotted slot on the wicker frame. Glass should be placed on top of rubber stoppers in order to prevent damage.

