

ASSEMBLY INSTRUCTION







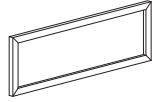

Thank you for purchasing this quality product. Be sure to check all packing material carefully for small parts which may have come loose inside the carton during shipment. Separate, identify and count all parts and hardware. Compare with the parts list to be sure all parts are present.

"DO NOT TIGHTEN SCREWS UNTIL COMPLETELY ASSEMBLED"

IMPORTANT:

PLEASE READ INSTRUCTION BEFORE STARTING THE ASSEMBLY

HARDWARE LIST				
ITEM	DESCRIPTION	DRAWING	SIZE	QTY
A	JCBB SCREW		M8 X 20MM	8PCS
B	JCBC SCREW		M8 X 25MM	8PCS
C	JCBC SCREW		M8 X 35MM	6PCS
D	JCBC SCREW		M6 X 35MM	8PCS
E	SPRING WASHER		M8 X 14MM	14PCS
F	FLAT WASHER		M8 X 22MM	14PCS
G	SCREW		M4 X 32MM	8PCS
H	L - KEY		M4 X 65MM	1PC
I	L - KEY		M5 X 65MM	1PC

PART LIST			
ITEM	DESCRIPTION	DRAWING	QTY
1	HEADBOARD		1PC
2	HEADBOARD LEG (R)		1PC
3	HEADBOARD LEG (L)		1PC
4	FOOTBOARD		1PC
5	SIDE RAIL		2PCS
6	SIDE RAIL		2PCS
7	SLAT		4PCS
8	SUPPORT LEG		8PCS
9	SIDE RAIL SUPPORT LEG		2PCS

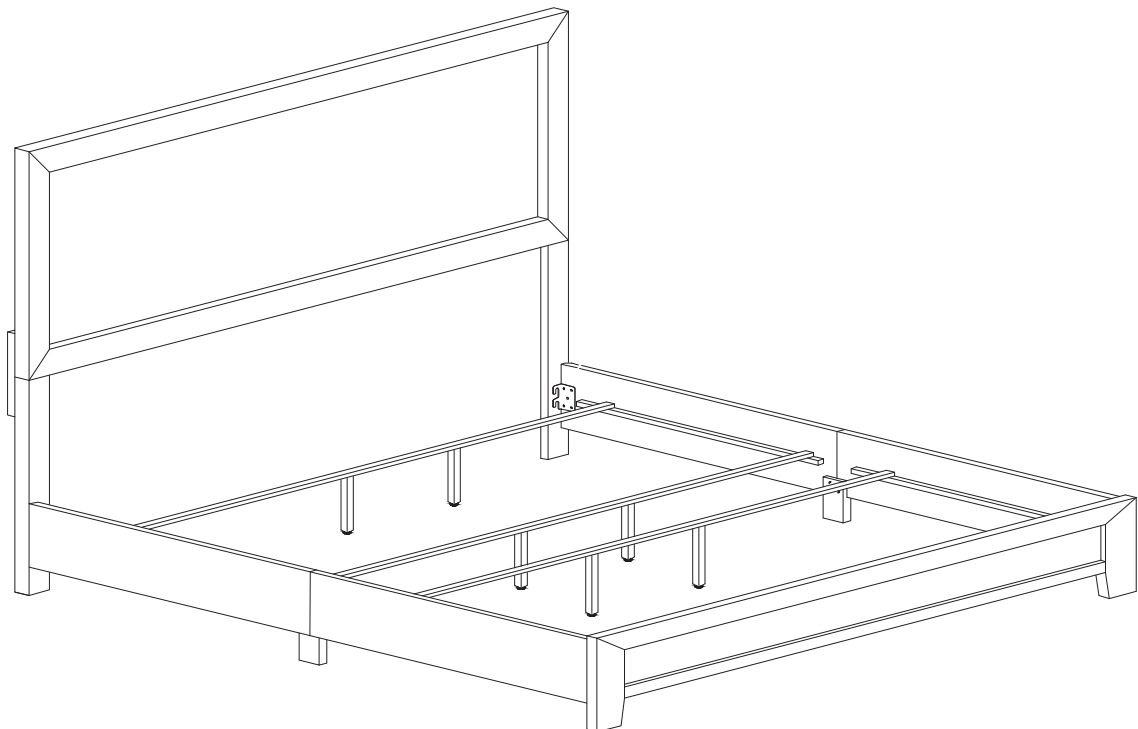

ASSEMBLY INSTRUCTION

STEP 1

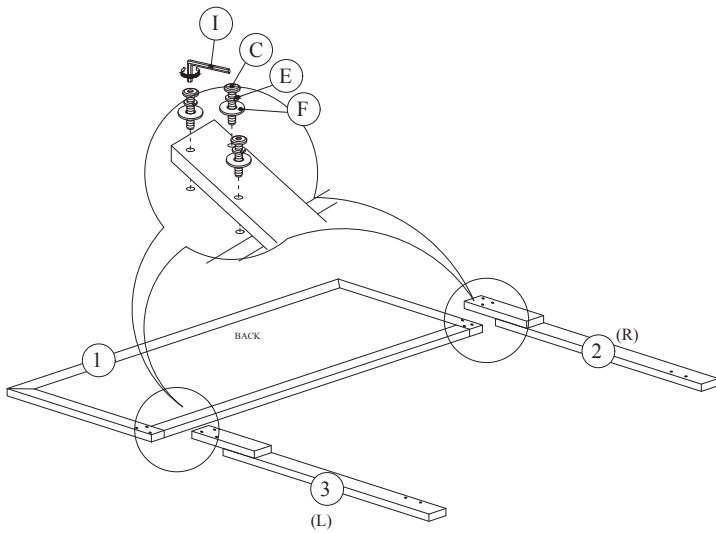

STEP 2

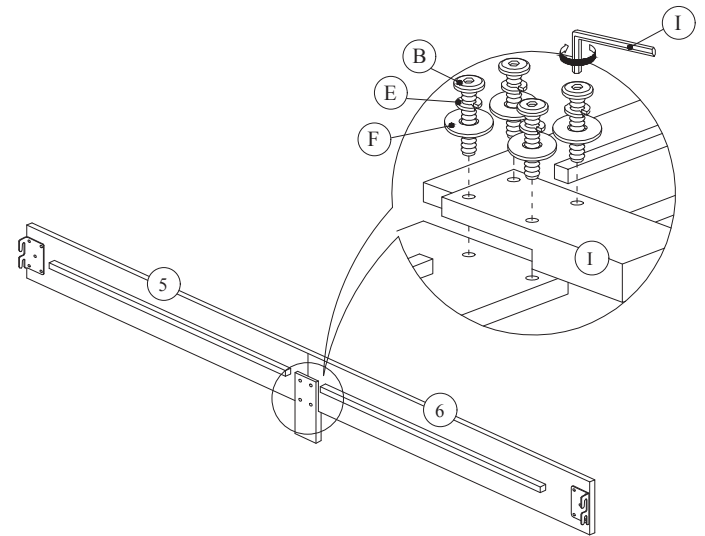

STEP 3

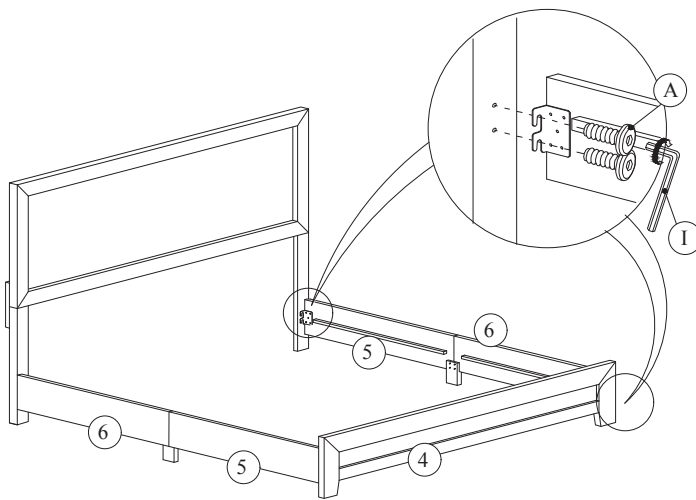

STEP 4

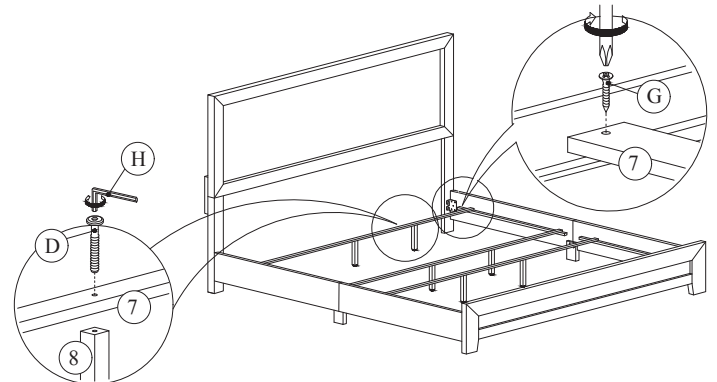

STEP 5

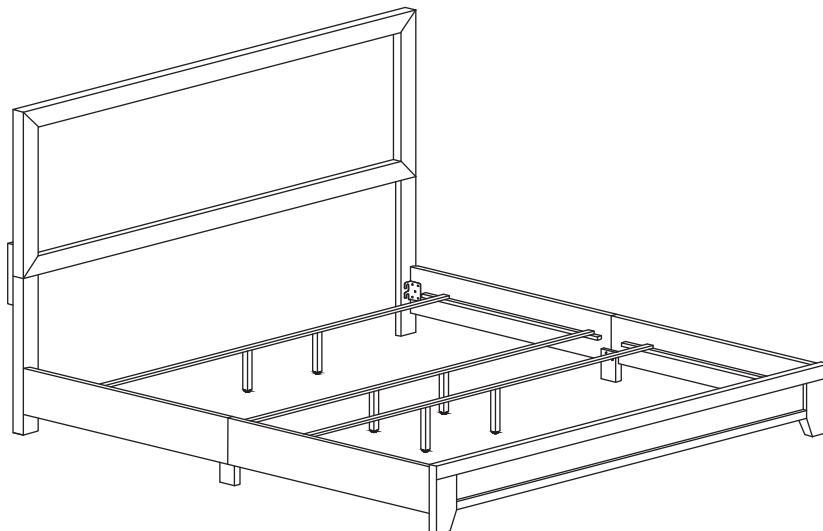

ASSEMBLY
COMPLETED