



WARNING!

Children have died from furniture tipover. Fixed wall device have been included with this product;you must install the fixed wall device according to these instructions in order to minimize the risk of furniture.If you have any questions about this product or the Fixed wall device , please contact us immediately.

Never allow children to climb or hang on furniture,including drawers or cabiner doors.

In addition to installing the restrains,to help prevent tip-over.







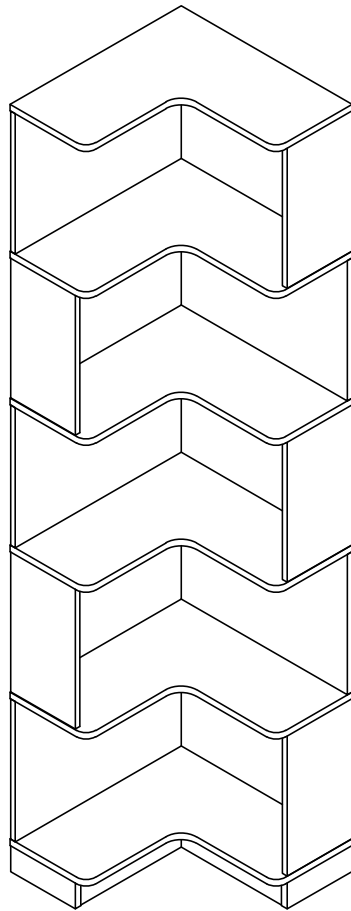

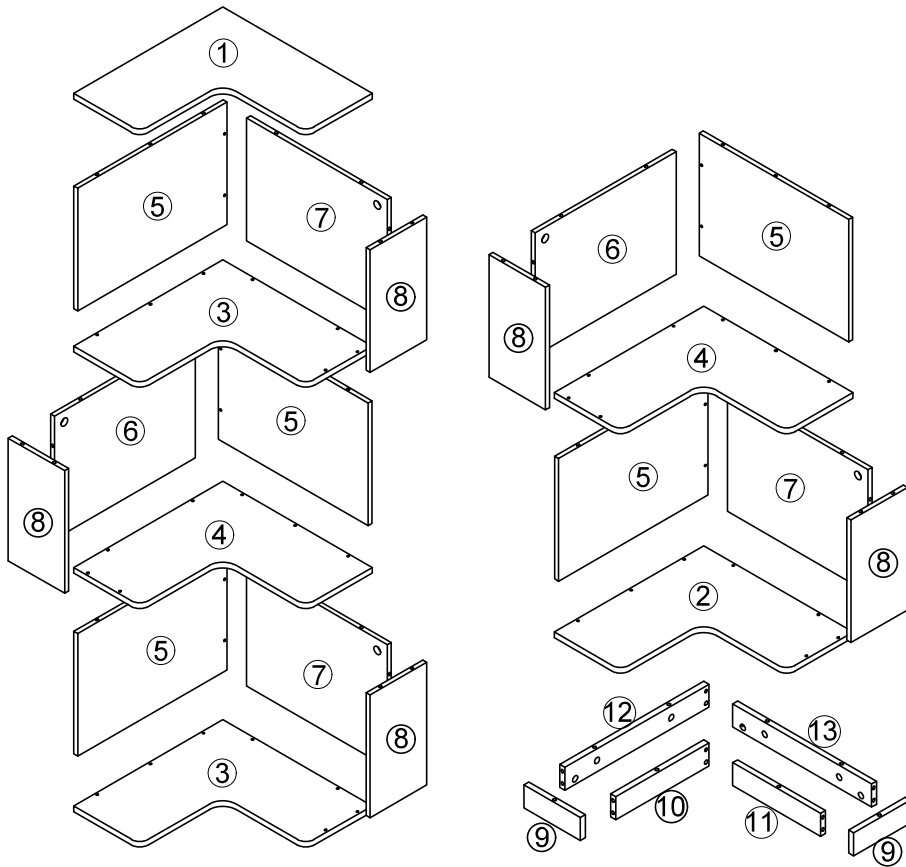
1. Never put a TV or other heavy objects on top of this product.
2. Do not stand on the product.



⚠ WARNING	
	<p>Children have died from furniture tipover. To reduce the risk of furniture tipover:</p> <ul style="list-style-type: none">• ALWAYS install tipover restraint provided.• NEVER put a TV on this product.• NEVER allow children to stand, climb or hang on drawers, doors, or shelves.• NEVER open more than one drawer at a time.• Place heaviest items in the lowest drawers.• Do not defeat or remove the drawer interlock system.
	<p><i>This is a permanent label. Do not remove!</i></p>

Installation & Assembly

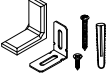

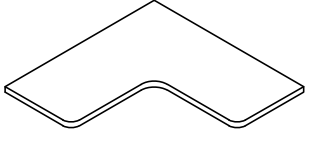
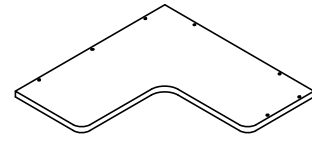
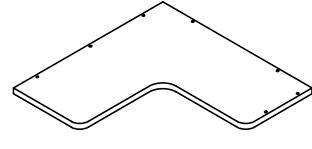
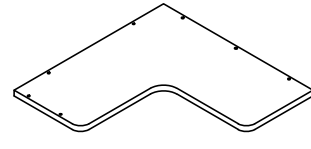
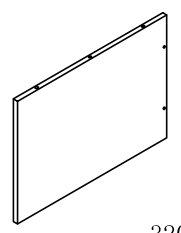
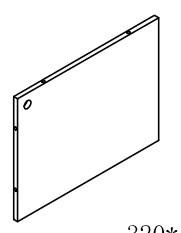
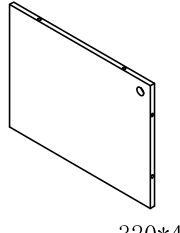

<p>A</p>  <p>14PCS</p>	<p>B</p>  <p>14PCS</p>	<p>C</p> <p>8*40</p>  <p>6PCS</p>	<p>D</p>  <p>80PCS</p>	<p>E</p>  <p>80PCS</p>	<p>F</p> <p>6*30</p>  <p>10PCS</p>	<p>G</p>  <p>20PCS</p>	<p>H</p>  <p>2PCS</p>	<p>LED</p>  <p>1PCS</p>
--	---	--	---	---	---	---	--	--

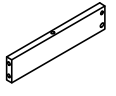
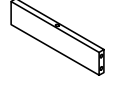
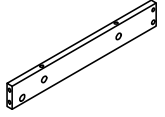
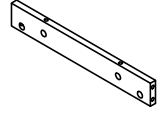
<p>1</p>  <p>450*450 1PS</p>	<p>2</p>  <p>450*450 1PS</p>	<p>3</p>  <p>450*450 2PS</p>	<p>4</p>  <p>450*450 2PS</p>
<p>5</p>  <p>320*450 5PS</p>	<p>6</p>  <p>320*424 2PS</p>	<p>7</p>  <p>320*424 3PS</p>	<p>8</p>  <p>320*170 5PS</p>
<p>9</p>  <p>170*60 2PS</p>	<p>10</p>  <p>281*60 1PS</p>	<p>11</p>  <p>265*60 1PS</p>	<p>12</p>  <p>434*60 1PS</p>
<p>13</p>  <p>418*60 1PS</p>			

"A" Hardware installation example

I

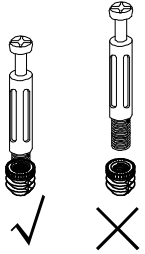

This part cannot be separated, please install in strict accordance with the assembly requirements

II

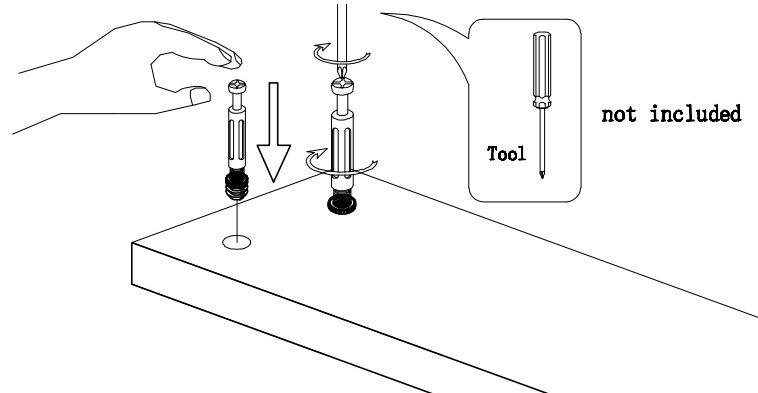

III

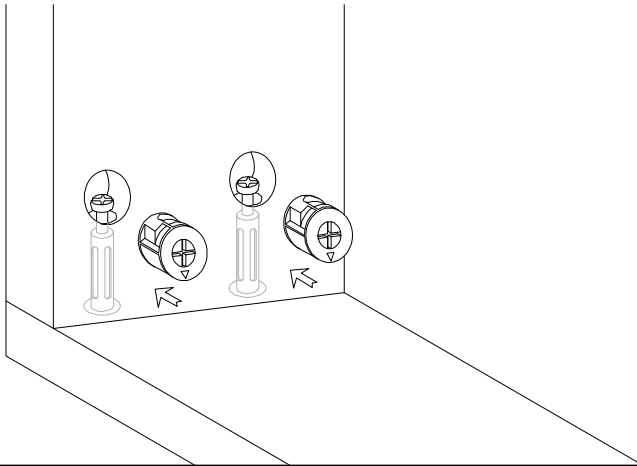

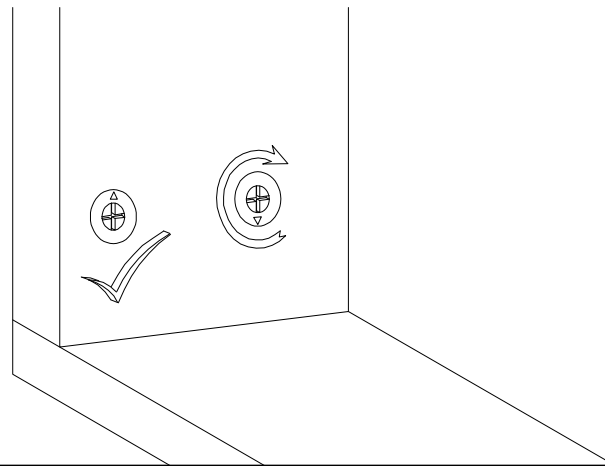

IV



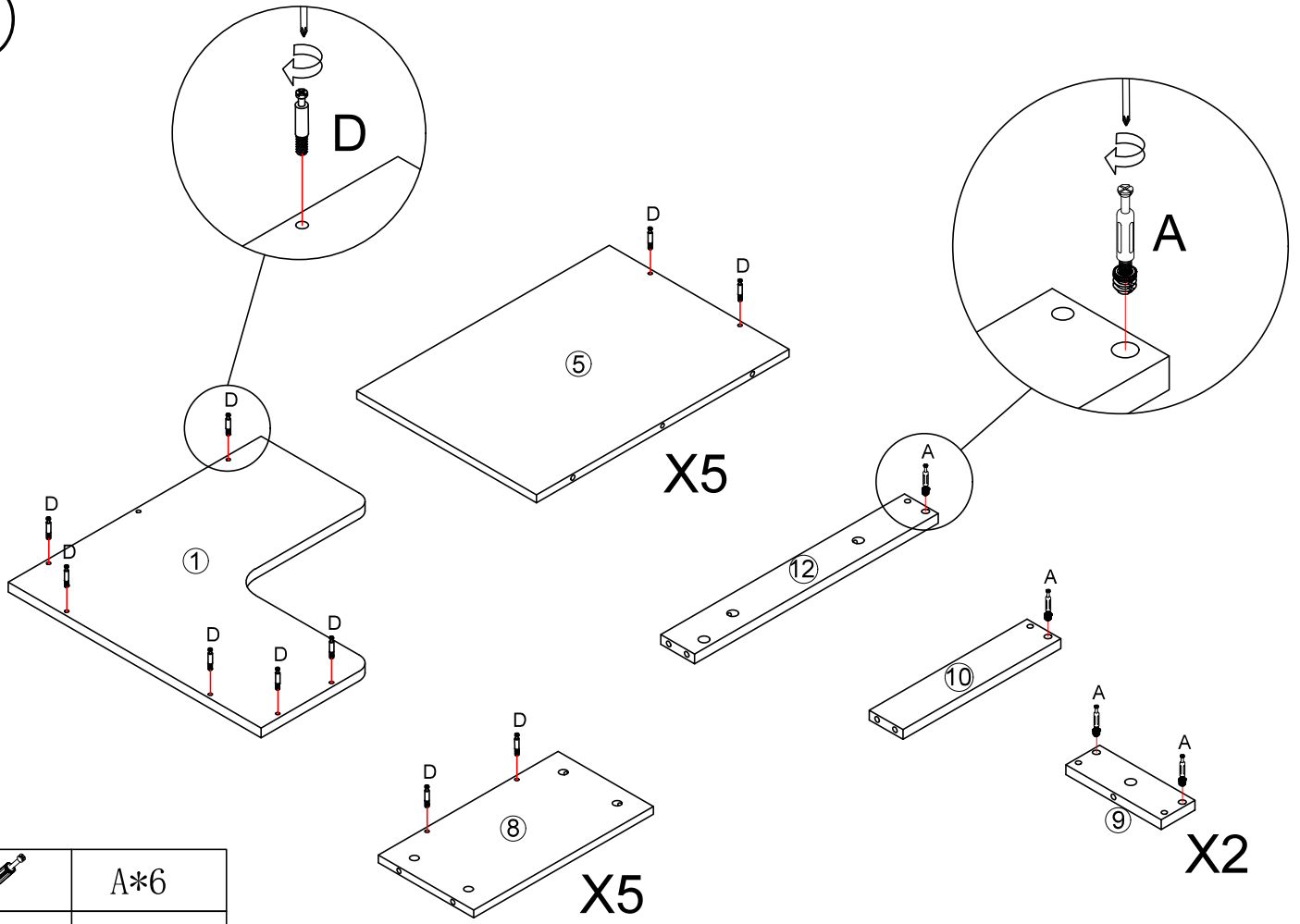

1

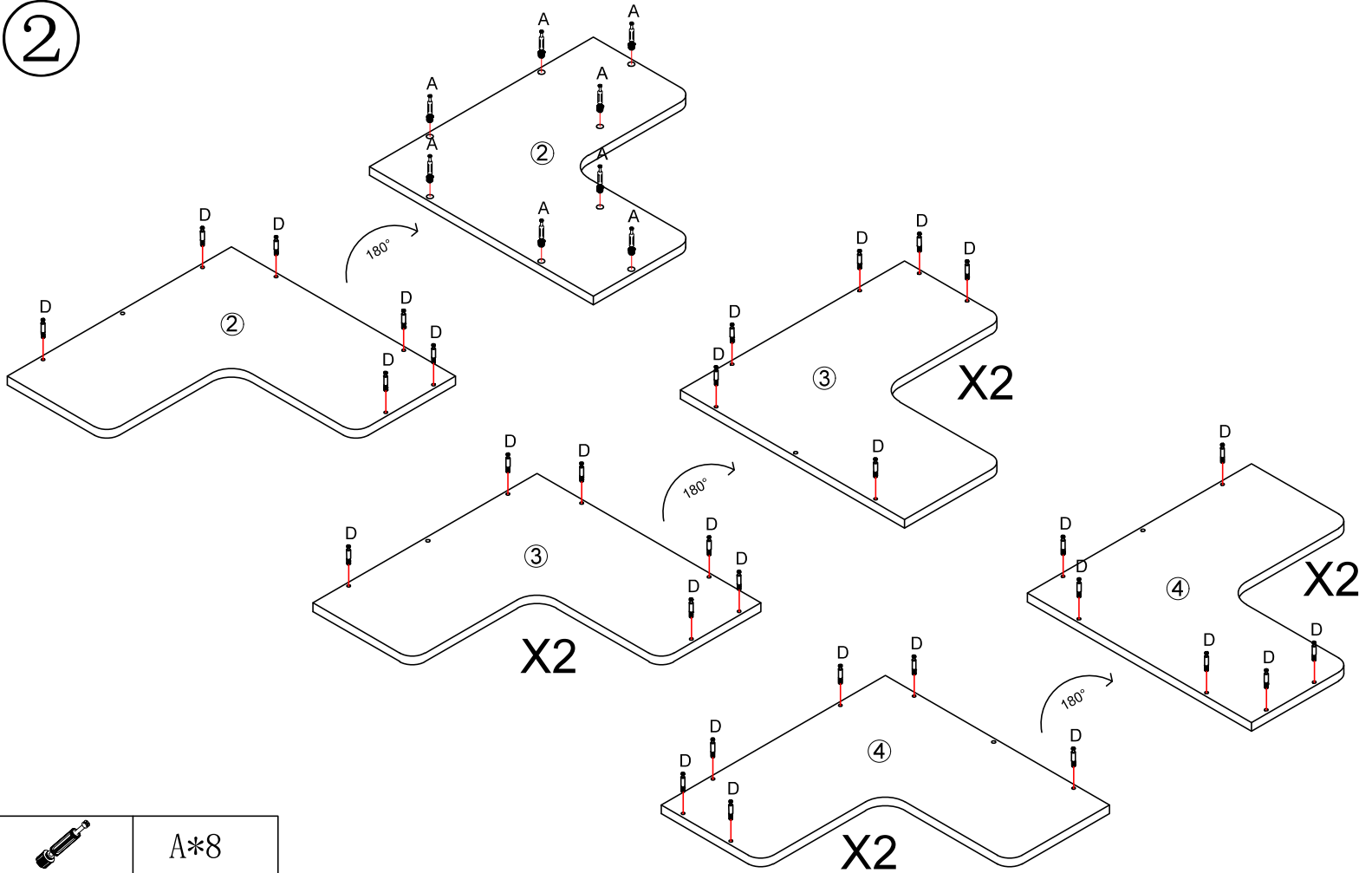

	A*6
	D*26

2



	A*8
	D*54

3

Make sure the arrow on the screw align to the hole on the side.

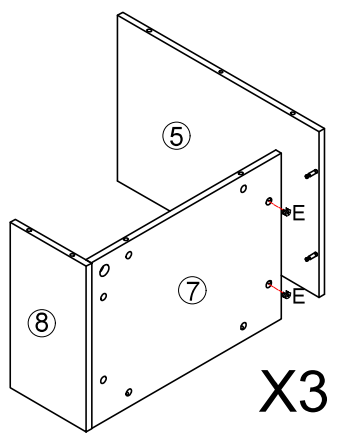
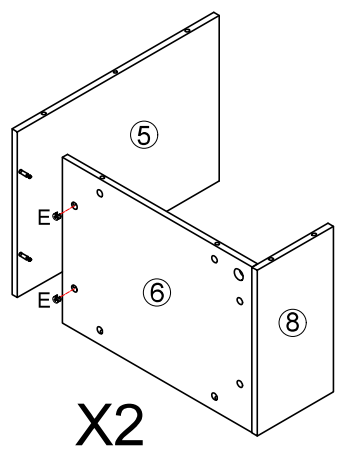
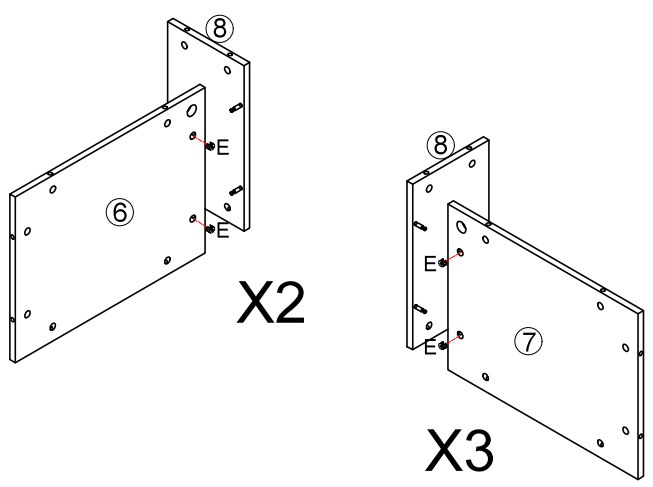
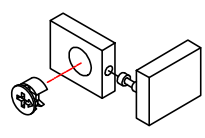



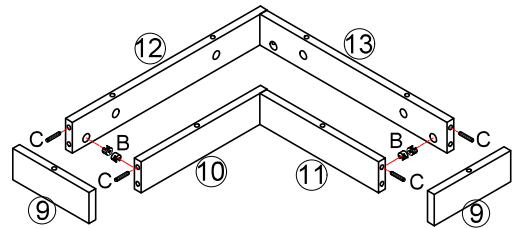
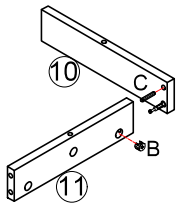
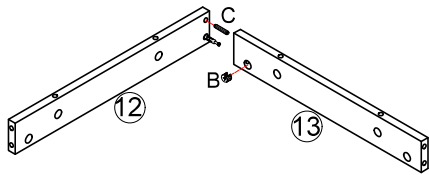

	E*10
--	------

	E*10
---	------

4



	B*2
	C*2

	B*4
	C*4

5

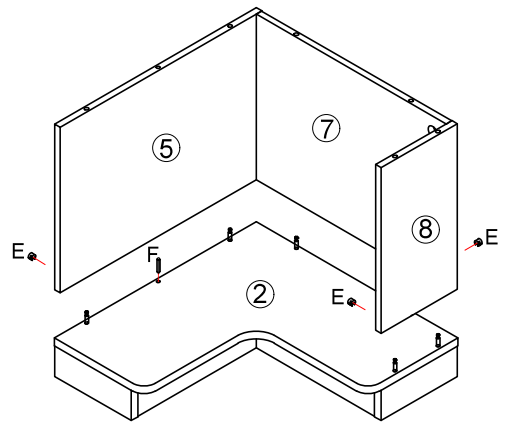
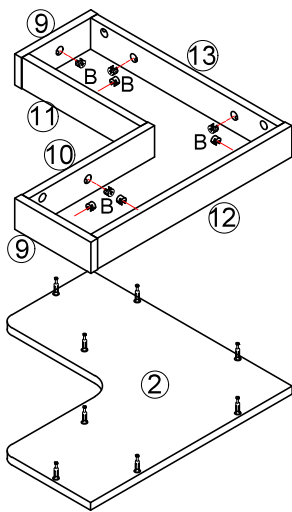

B*8





E*6



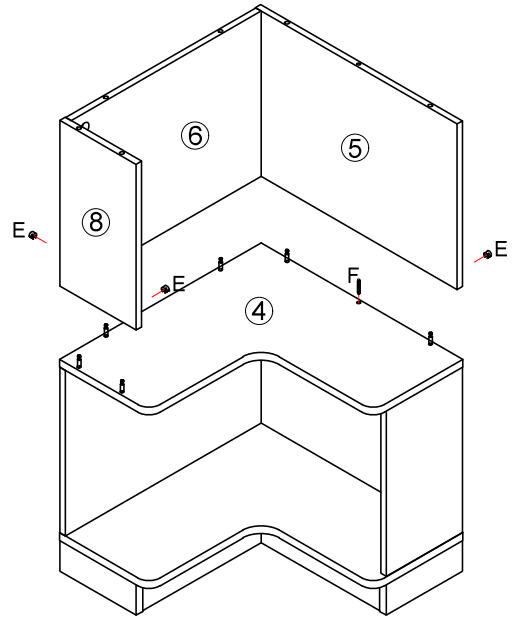
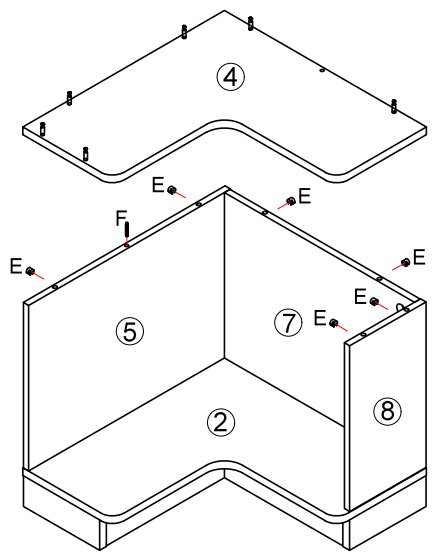

F*1

6





	E*6
	F*1

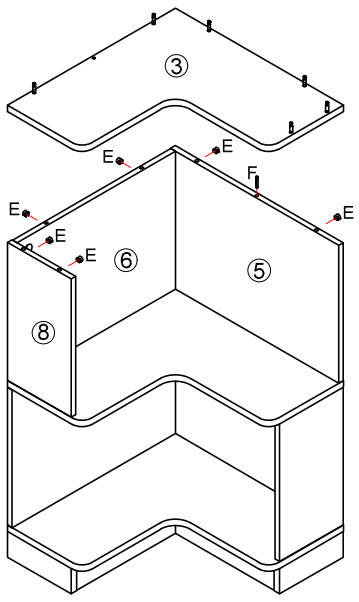

	E*6
	F*1

7



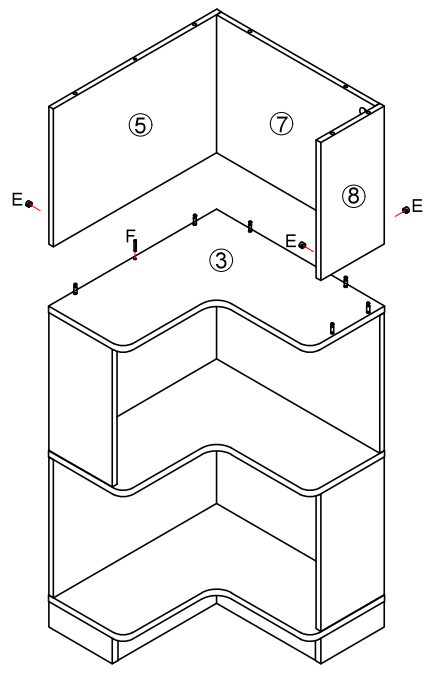

	E*6
	F*1



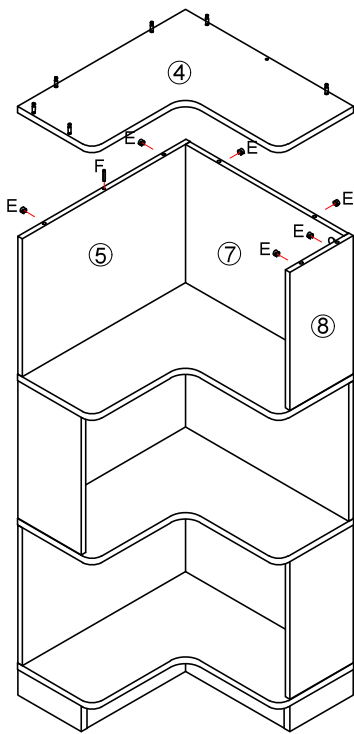

	E*6
	F*1

8



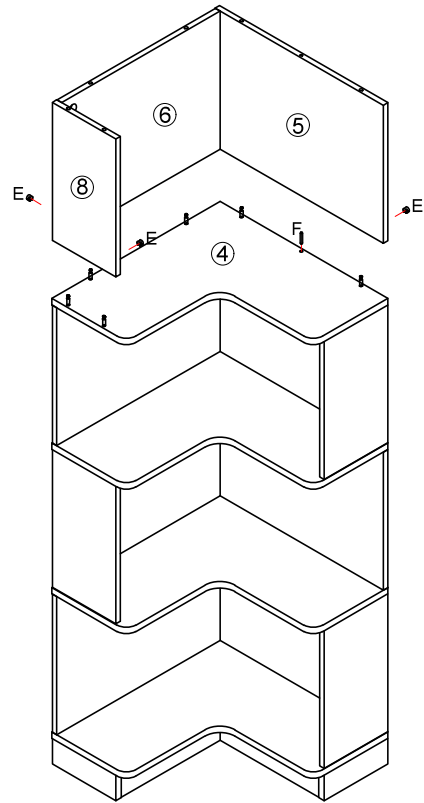

	E*6
	F*1



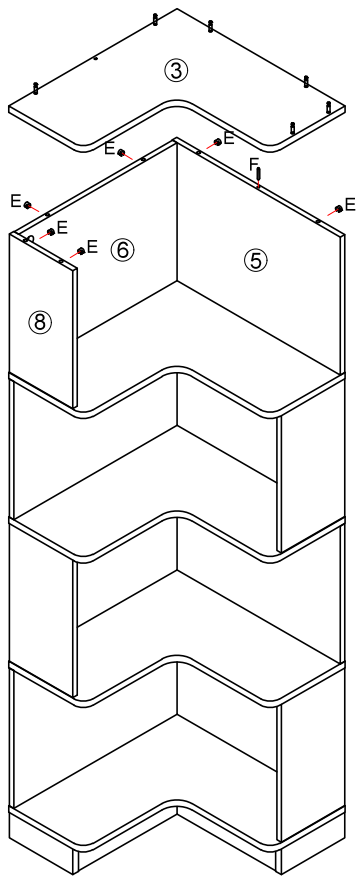

	E*6
	F*1

9



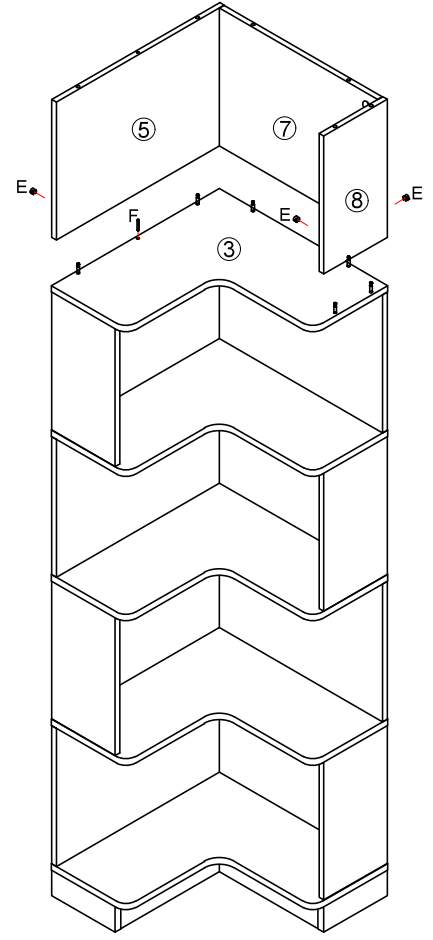



	E*6
	F*1

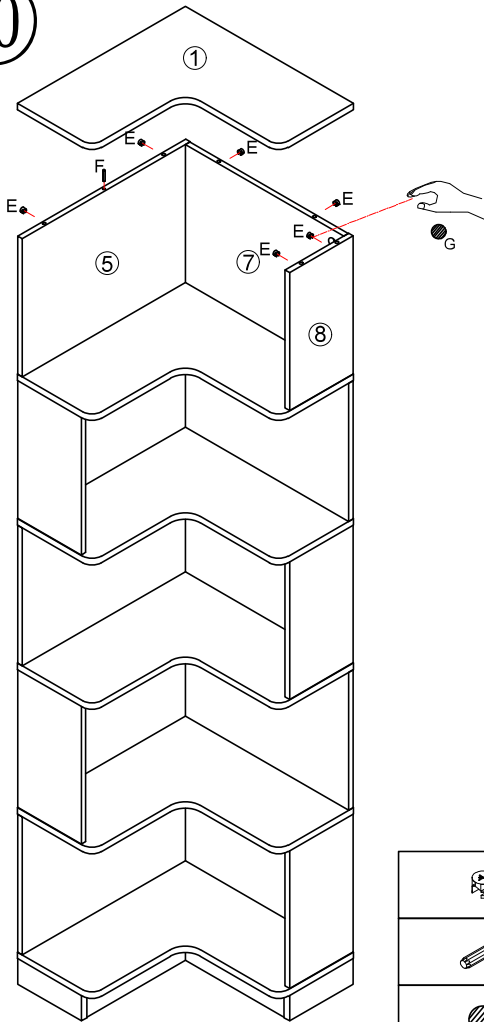

	E*6
	F*1

10



	E*6
	F*1
	G*20

LED light tape stick to the lower side of the board ⑤ ⑥ ⑦

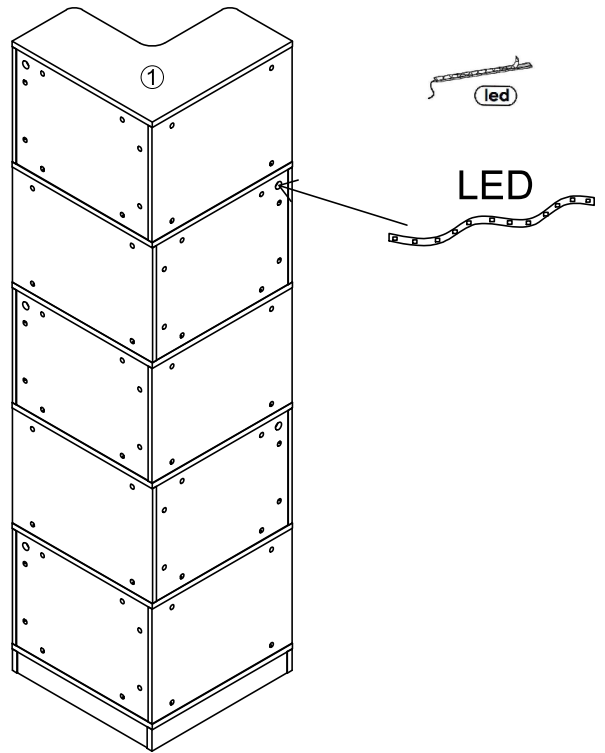

	LED*1
---	-------

11

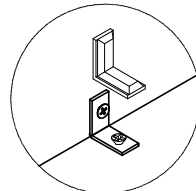
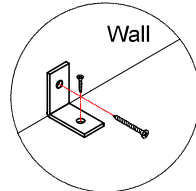
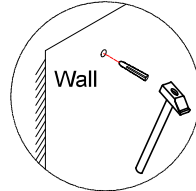
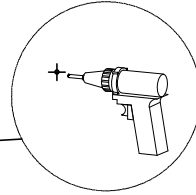
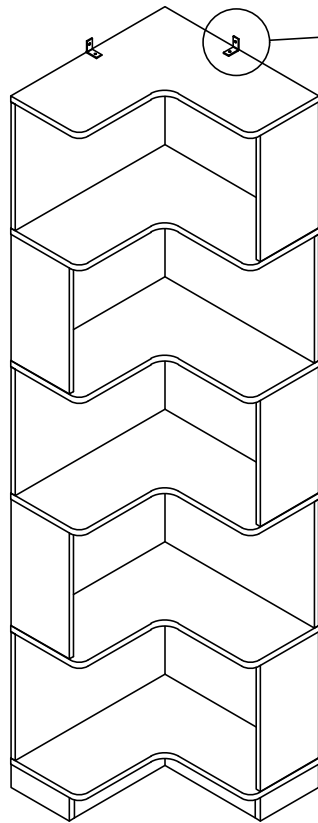

Please install tip-proof fitting.



H*2

LED Light

If you can't let the lights work successfully, please check the following:

1. Please check the direction of the connect, try it in the opposite direction, according to the following picture.
2. Please check the remote control, it need you to tear down the plastic septum before use it.
3. Don't let the remote control too far from the receiver, make sure there is no obstruction between them.

