

① x1

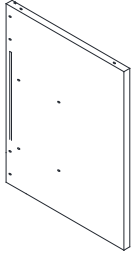

② x1

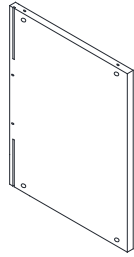

③ x2

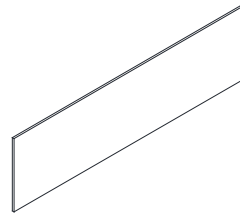

④ x1

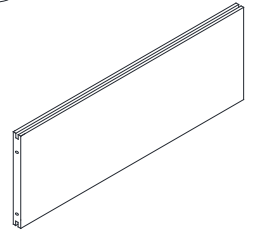

⑤ x2

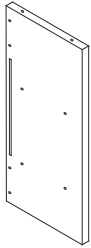

⑥ x4

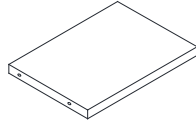

⑦ x4

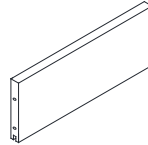

⑧ x2

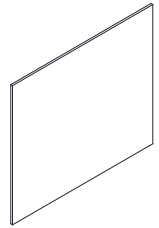

⑨ x1

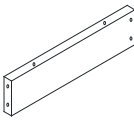

⑩ x1

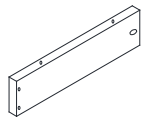

⑪ x1

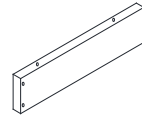

⑫ x1

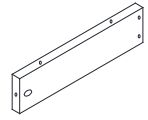

⑬ x2

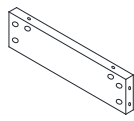

⑭ x1

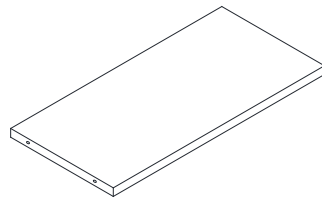

⑮ x1

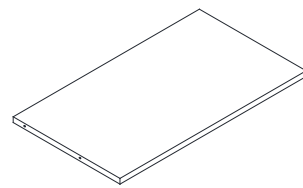

⑯ x1

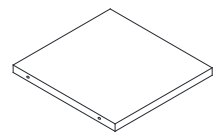

⑰ x1

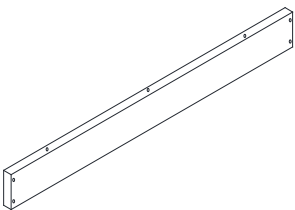

⑱ x1

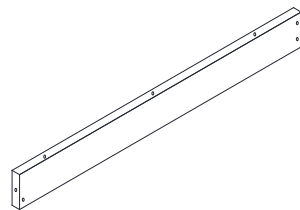

⑲ x1

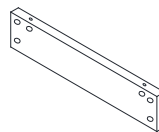

⑳ x1

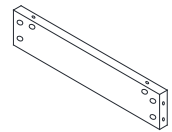

21 x1

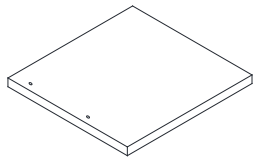

22 x1

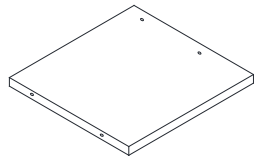

23 x1

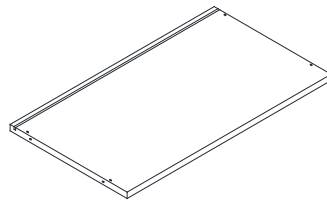

24-1 x1



24-2 x1



25 x6

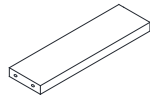

26 x6

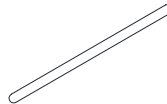

27 x1

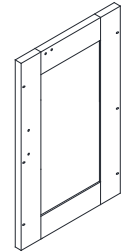

28-1 x1



28-2 x1



29 x1

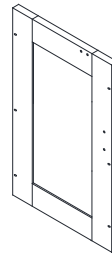

30 x1

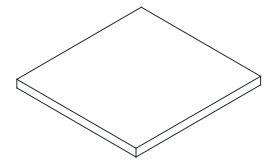

31 x1

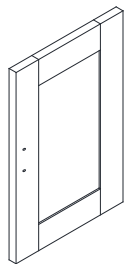

32 x1

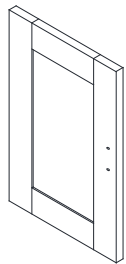

AX124

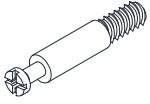

BX124



CX4

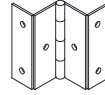

DX52



M4x14

E

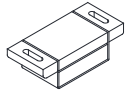

X2



X4

M3x16

F

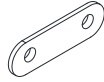

X2



X4

M3x12

GX12

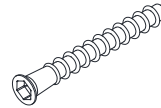

HX4



IX8



M4x20

JX4

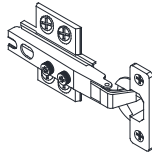

KX8

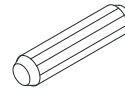

LX1

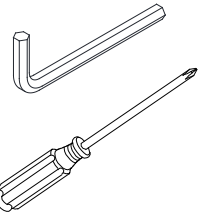

STEP 1



AX8

BX4

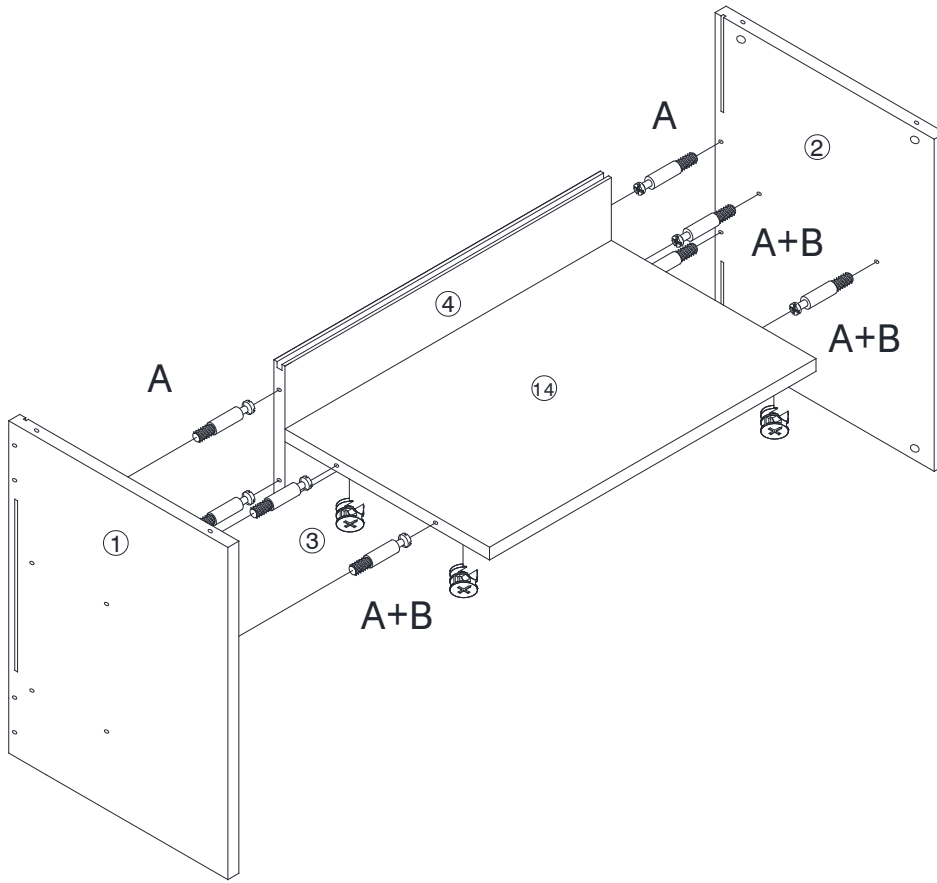

STEP 2



GX4

AX12



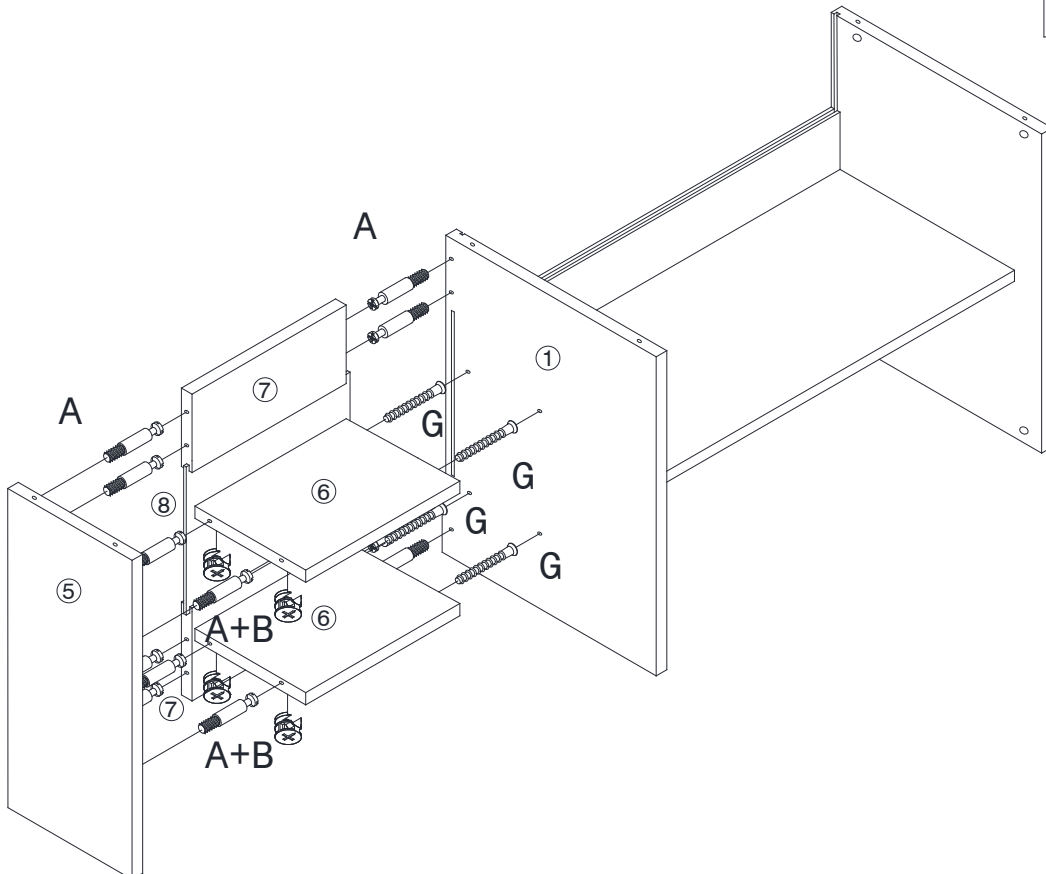

BX4



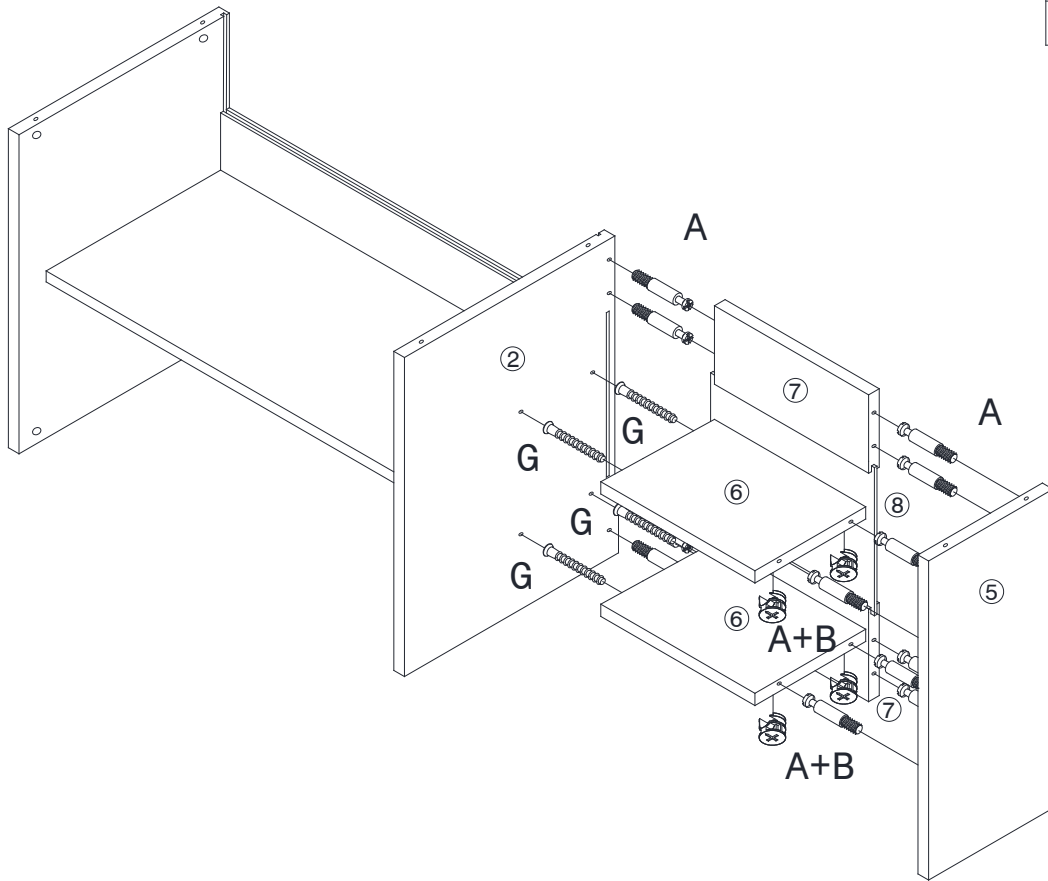

STEP 3





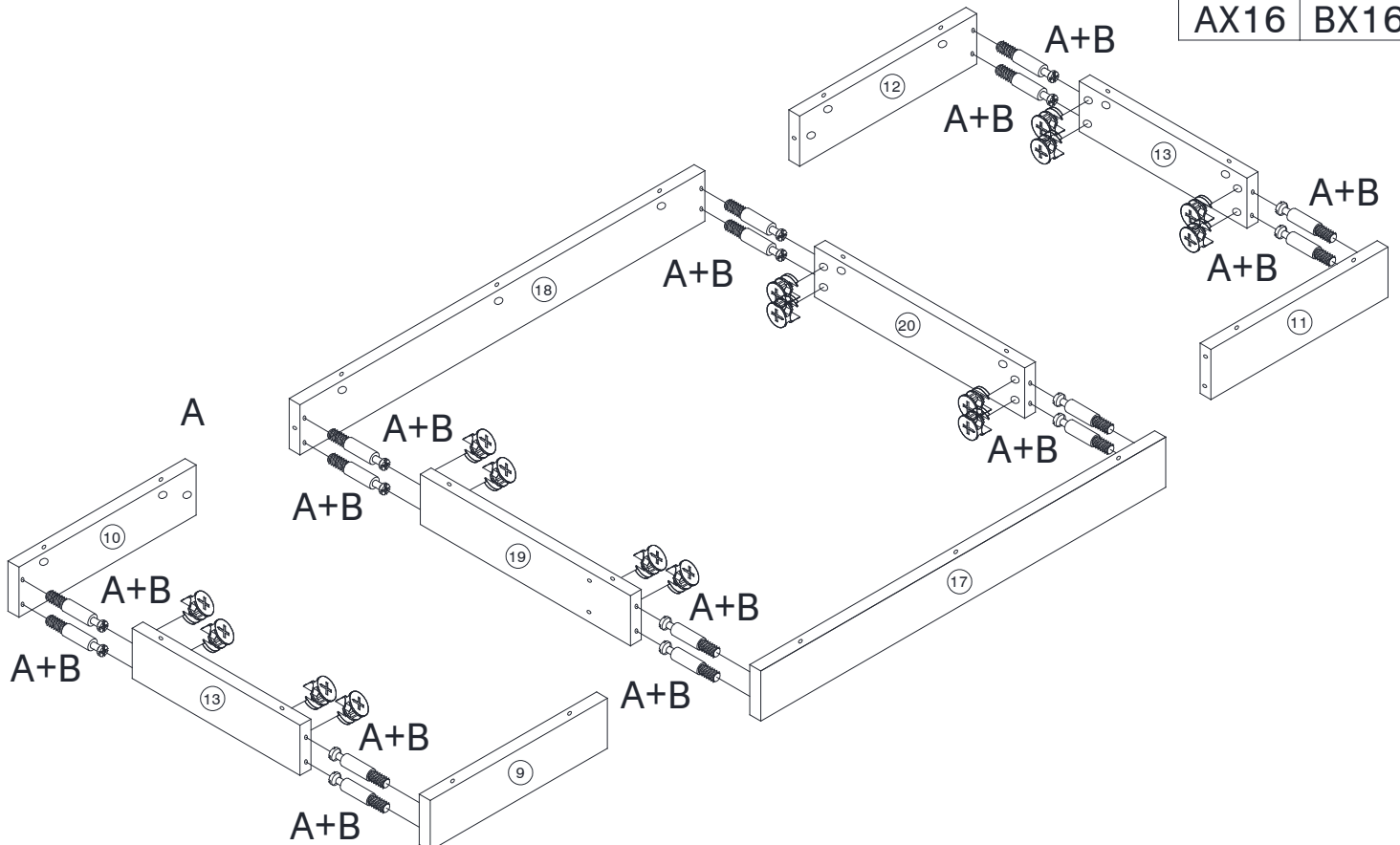

	
GX4	AX12
	
BX4	

STEP 4





	
AX16	BX16

STEP 5

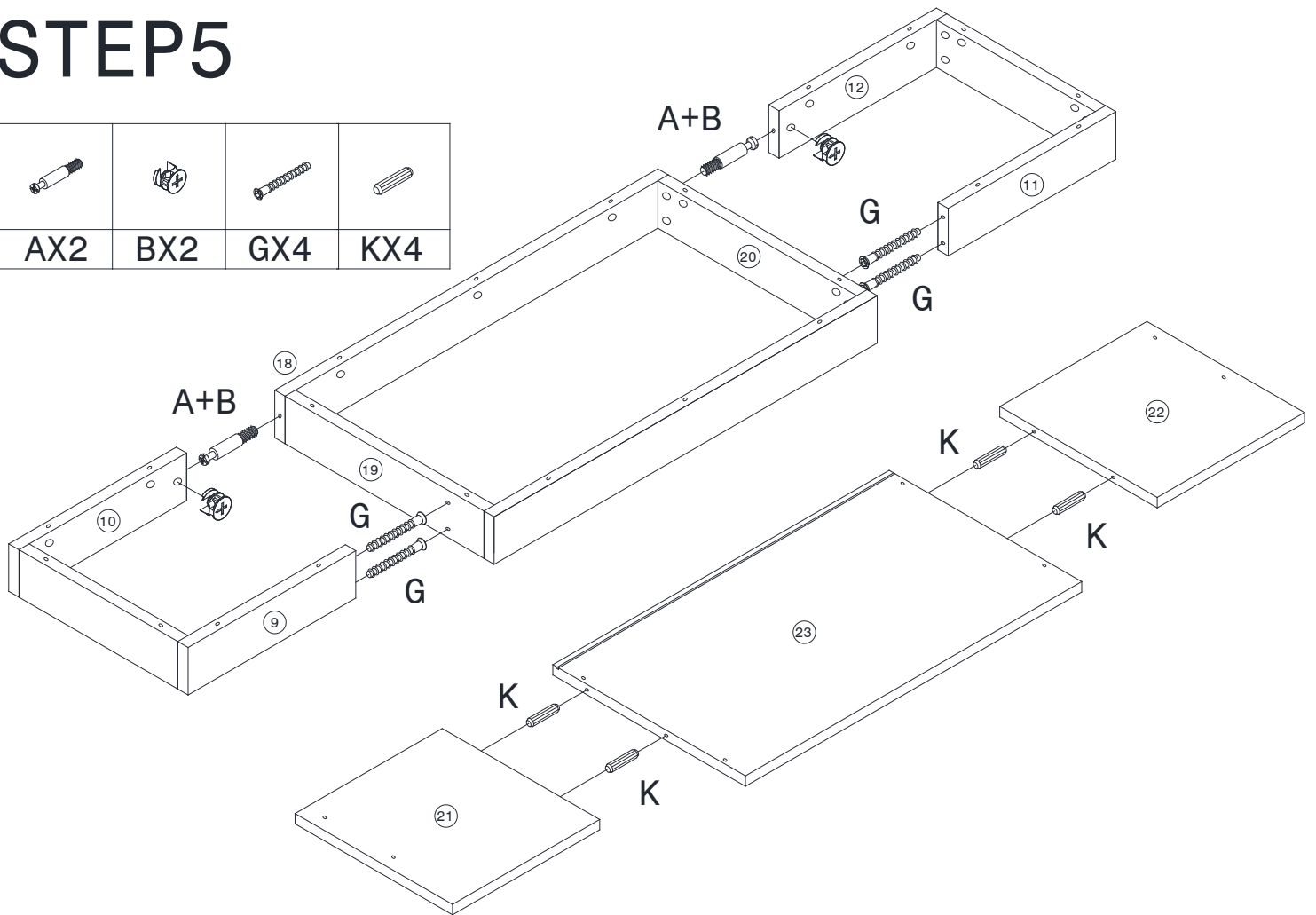
			
AX2	BX2	GX4	KX4



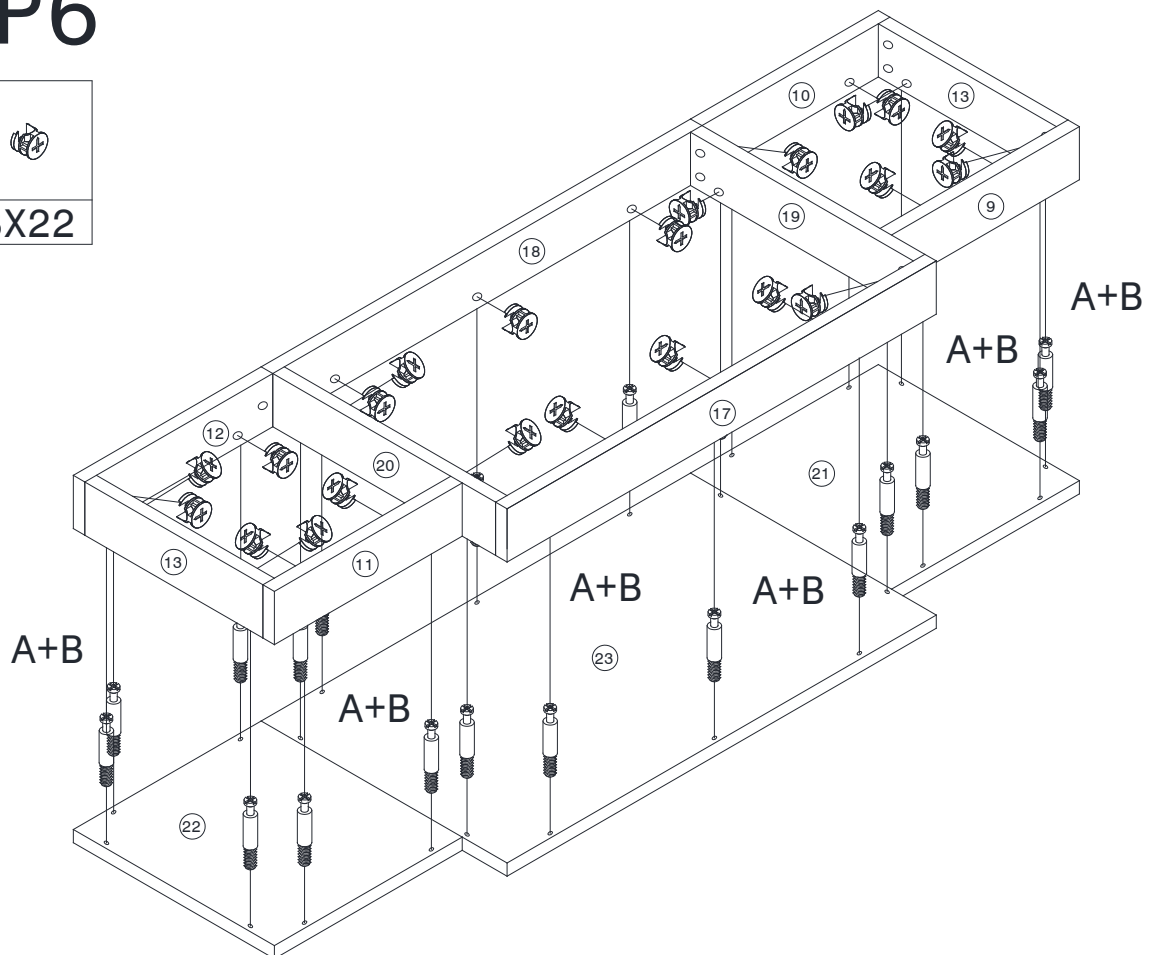

STEP 6

	
AX22	BX22



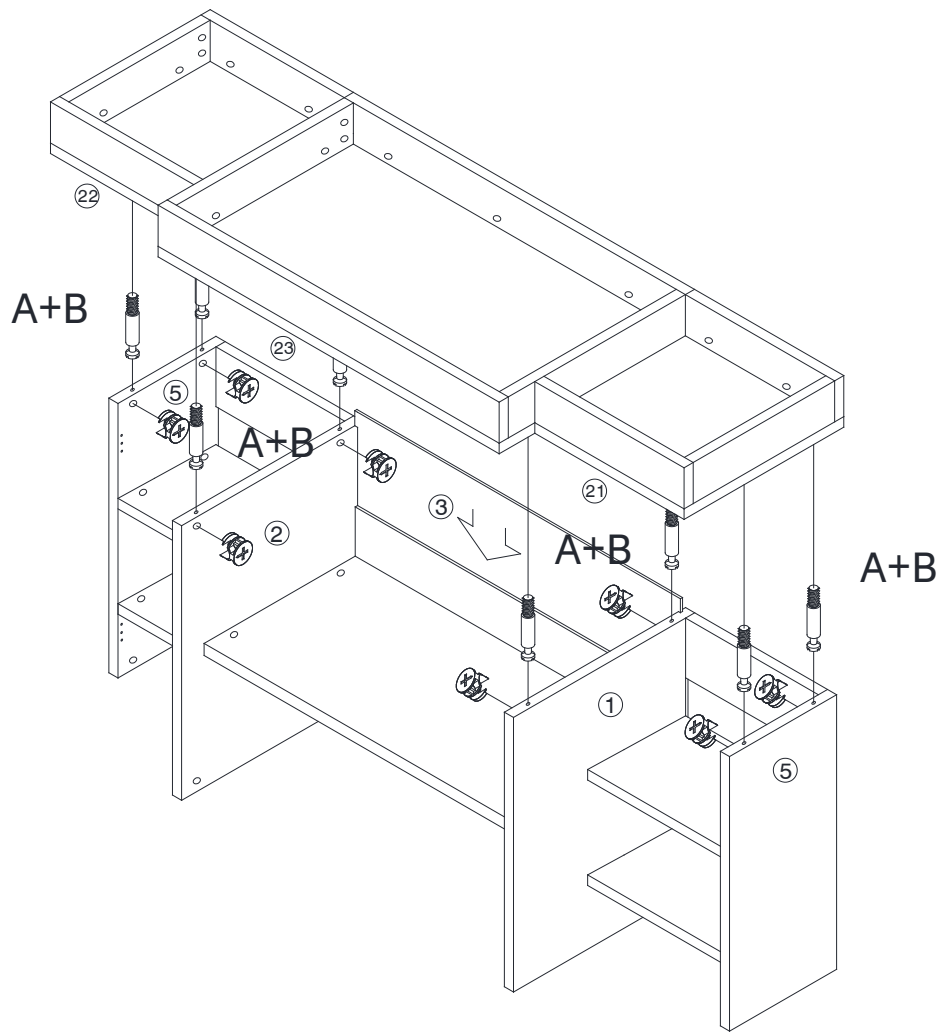

STEP 7

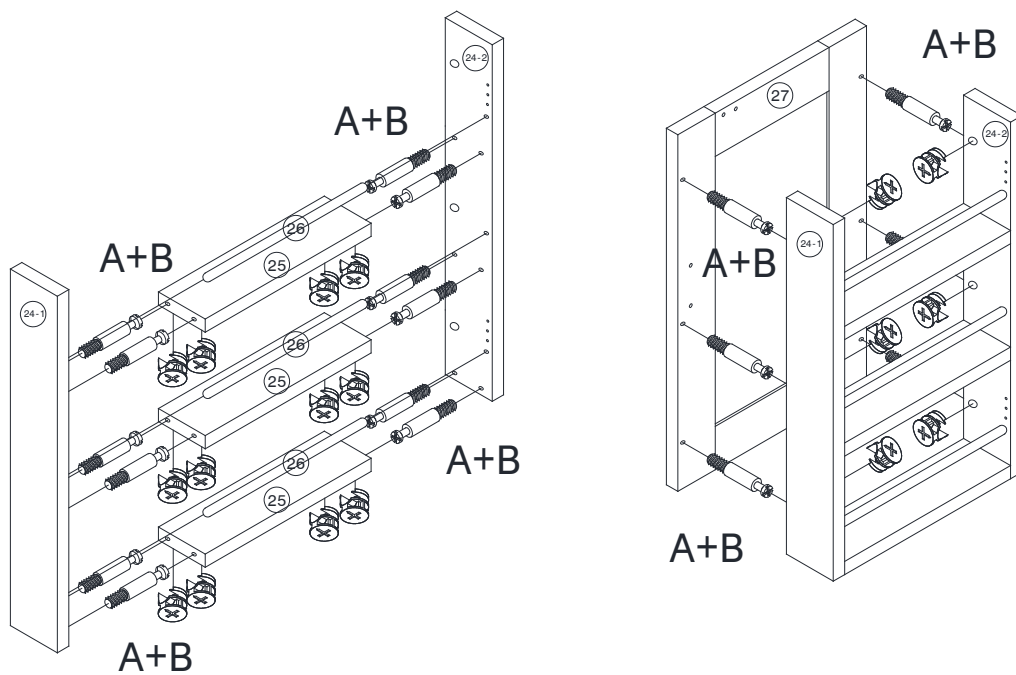

	
AX8	BX8

STEP 8



	
AX18	BX18

STEP 9



AX18

BX18

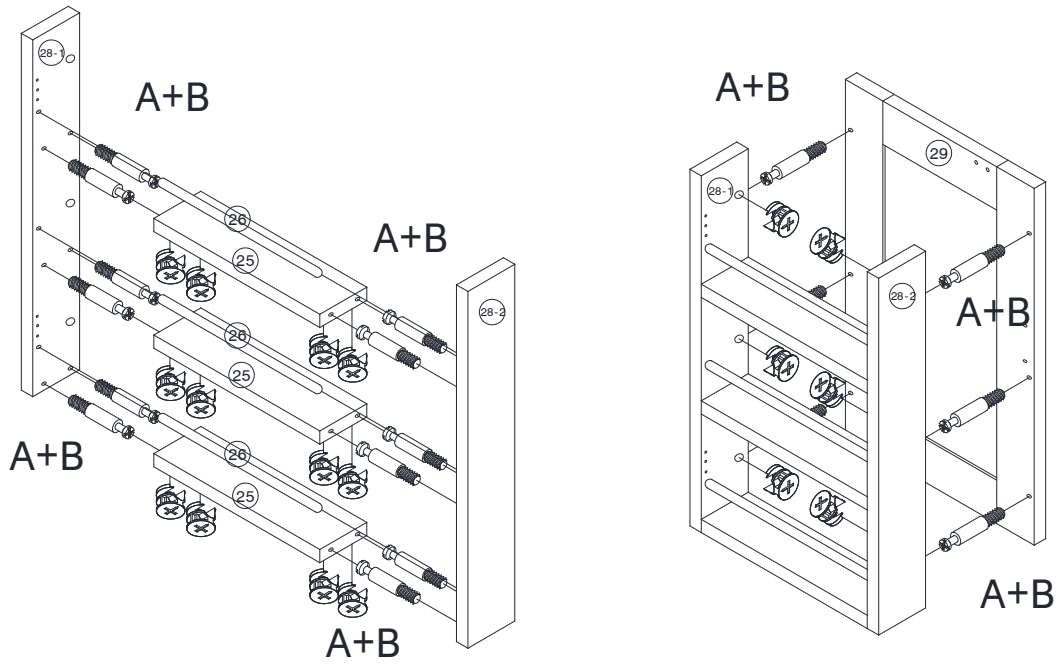

STEP 10

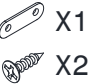

X1

X2



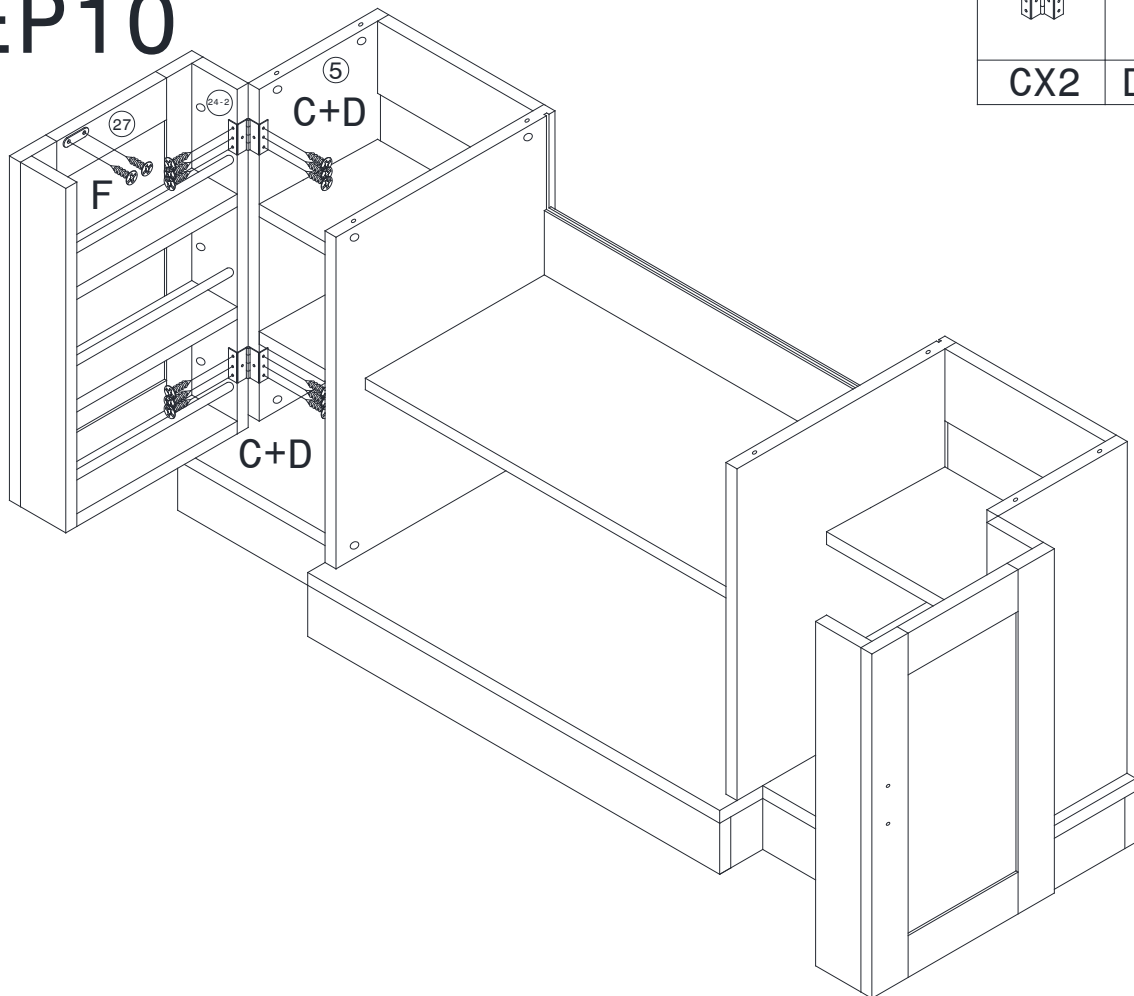

CX2

DX12

F



STEP 11

		 X1  X2
CX2	DX12	F

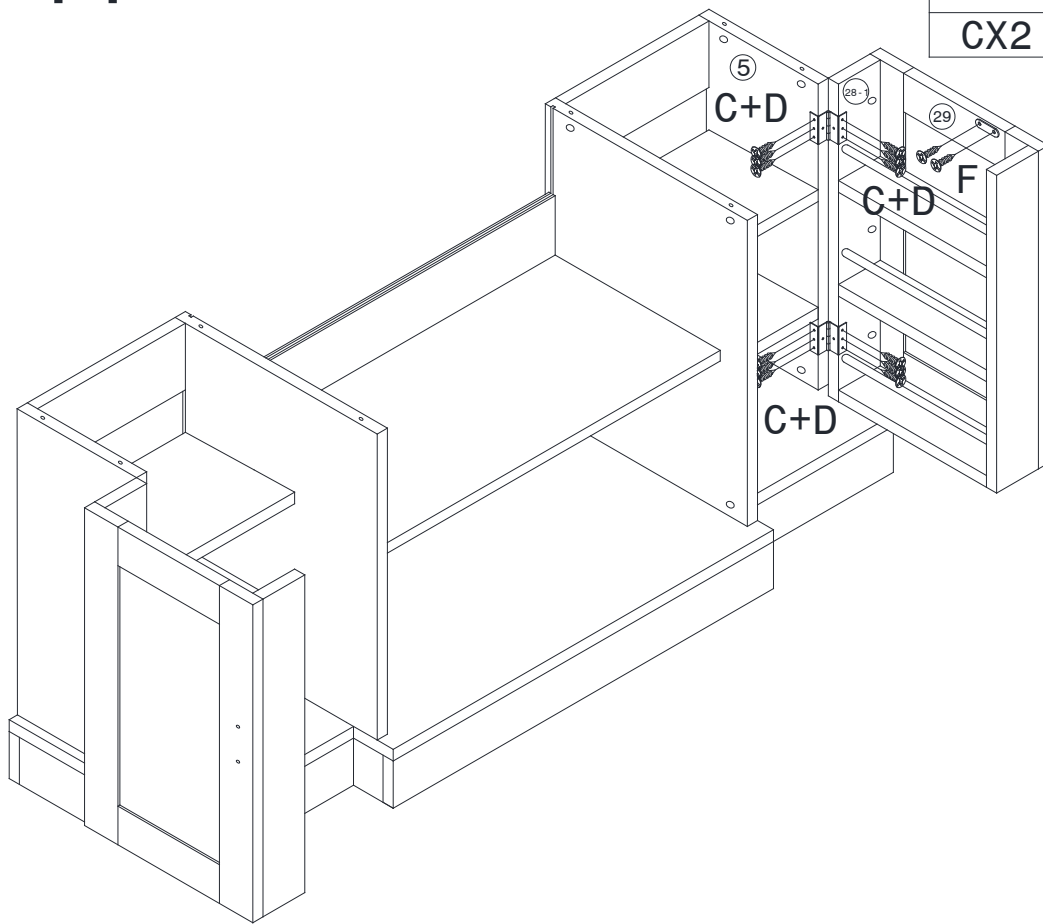

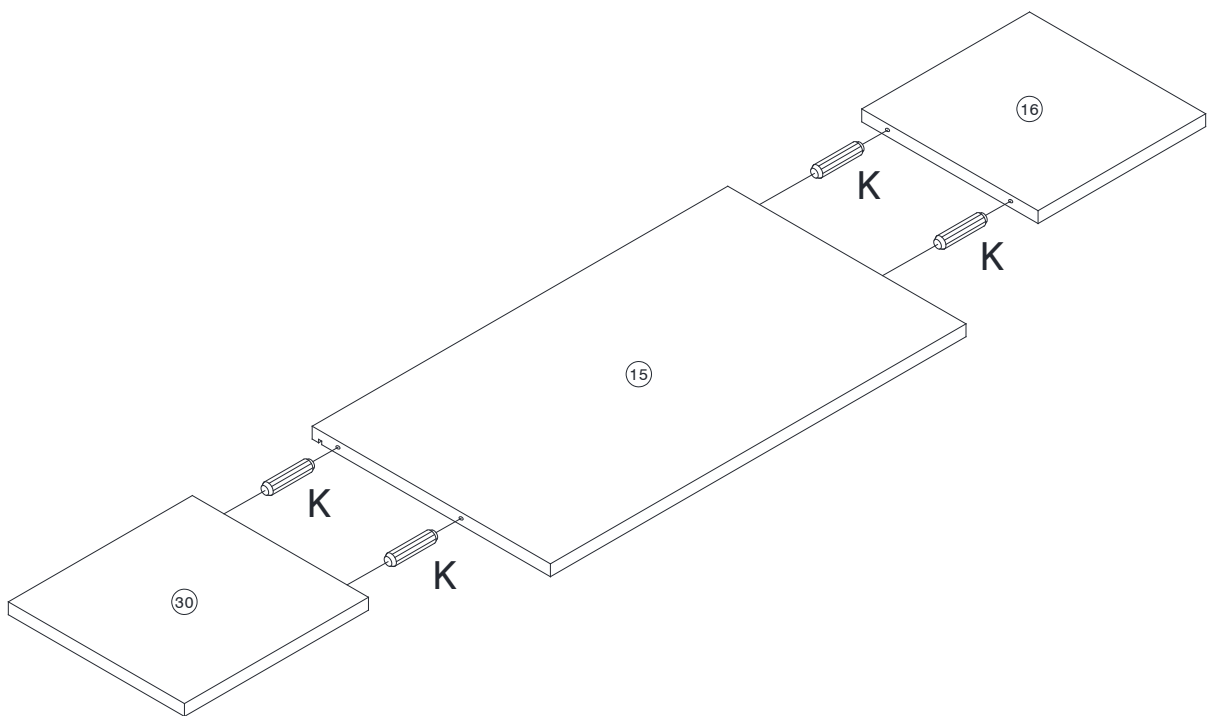

STEP 12

KX4



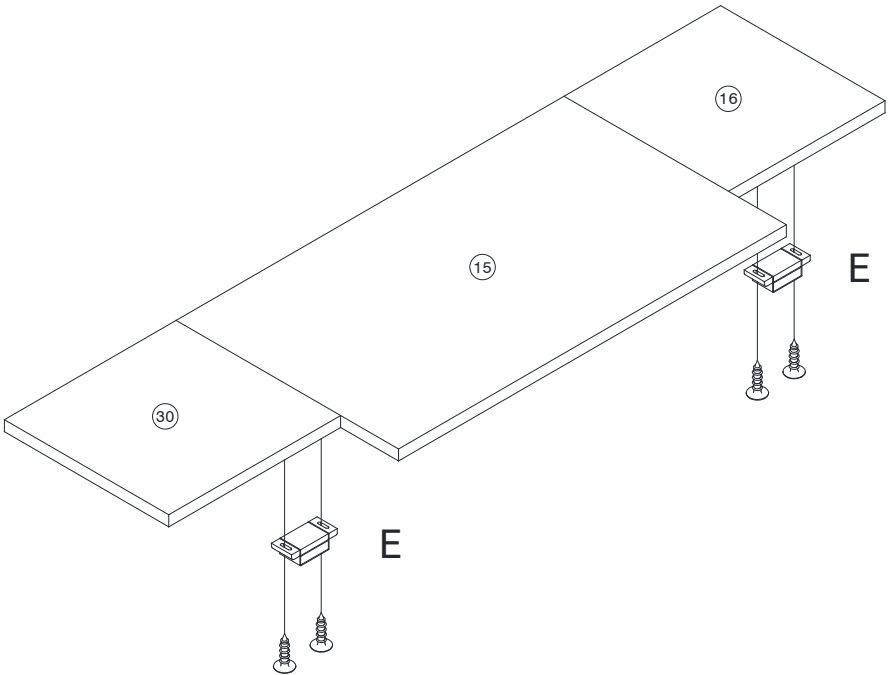

STEP 13

	X2
	X4
E	



STEP 14

	
AX8	BX8

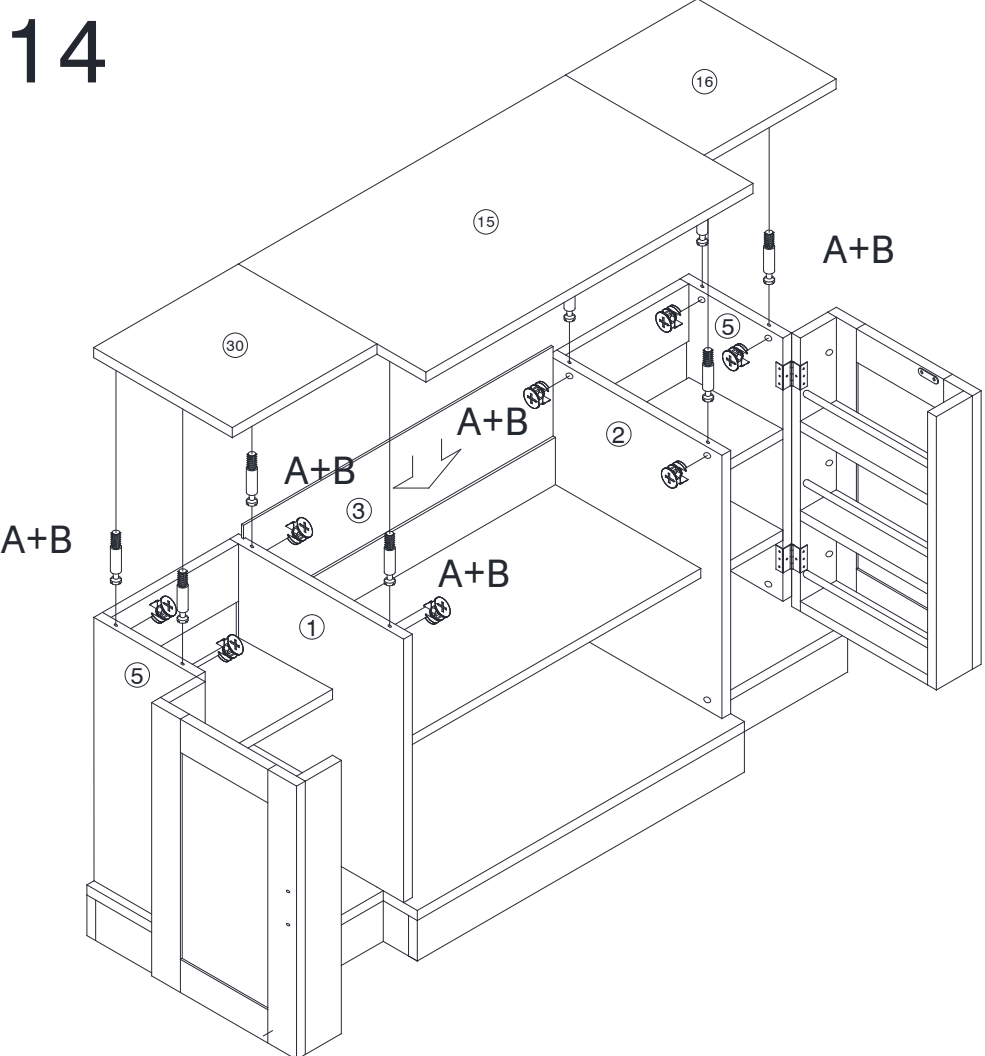

STEP 15



BX20

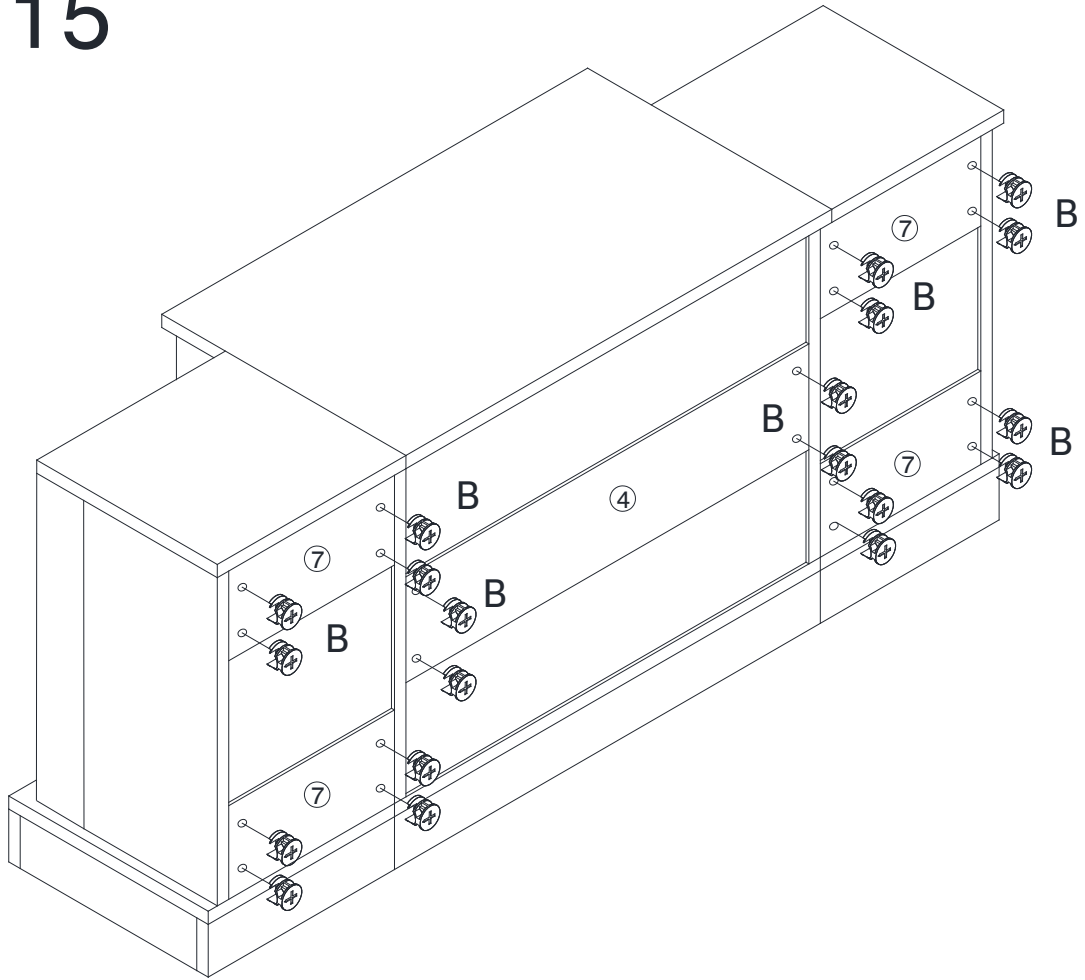

STEP 16



DX24

HX4



IX8

JX4

