





## CARE AND MAINTENANCE

Wipe clean with a soft, dry cloth. The seat board can be cleaned with a mild cleaner. Test the cleaning method on a hidden area before using them over the entire area.

## NOTICE

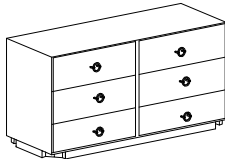
- \* Please make sure that you have all parts indicated before you begin assembly of this item.
- \* This item should be assembled on a soft surface to prevent scratching the finished product during assembly.
- \* This item may require periodic tightening.
- \* Do not tighten bolts until completely assembled.

## Part List and Hardware List

Piece	Description	Picture	Quantity
A	DRAWER		1 X
B	LEG		4 X
HW1	Allen bolt 5/16" - 18 x 3-1/4" Split lock Washer 5/16" Flat Washer 5/16"		8 X
HW2	ALLEN KEY 4mm		1 X
HW3	Anti-Tip Hardware		2X

Product Dimensions: 56"W\*18"D\*35"H

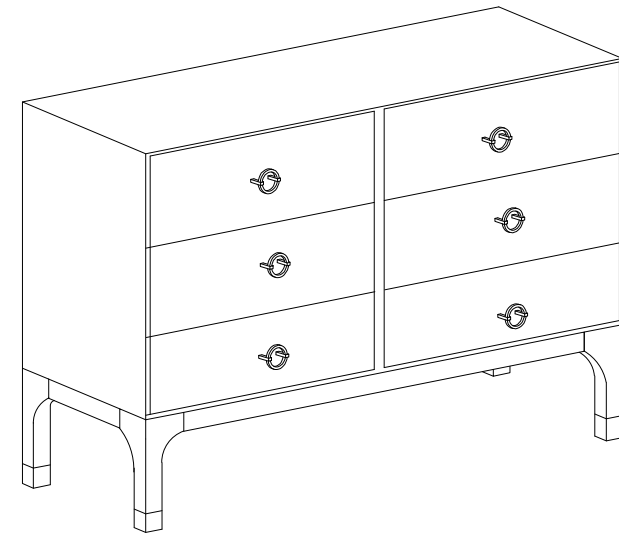

**Weight Capacity : 200 lbs**

**Warning : Do not stand on the product**

**Warning : Do not over torque bolts**

## PREPARATION

Before beginning assembly of product, make sure all parts are present. Compare parts with package contents list and hardware contents list. If any part is missing or damaged, do not attempt to assemble the product.

Estimated Assembly Time:15 minutes.

Tools Required for Assembly (included):Allen key.

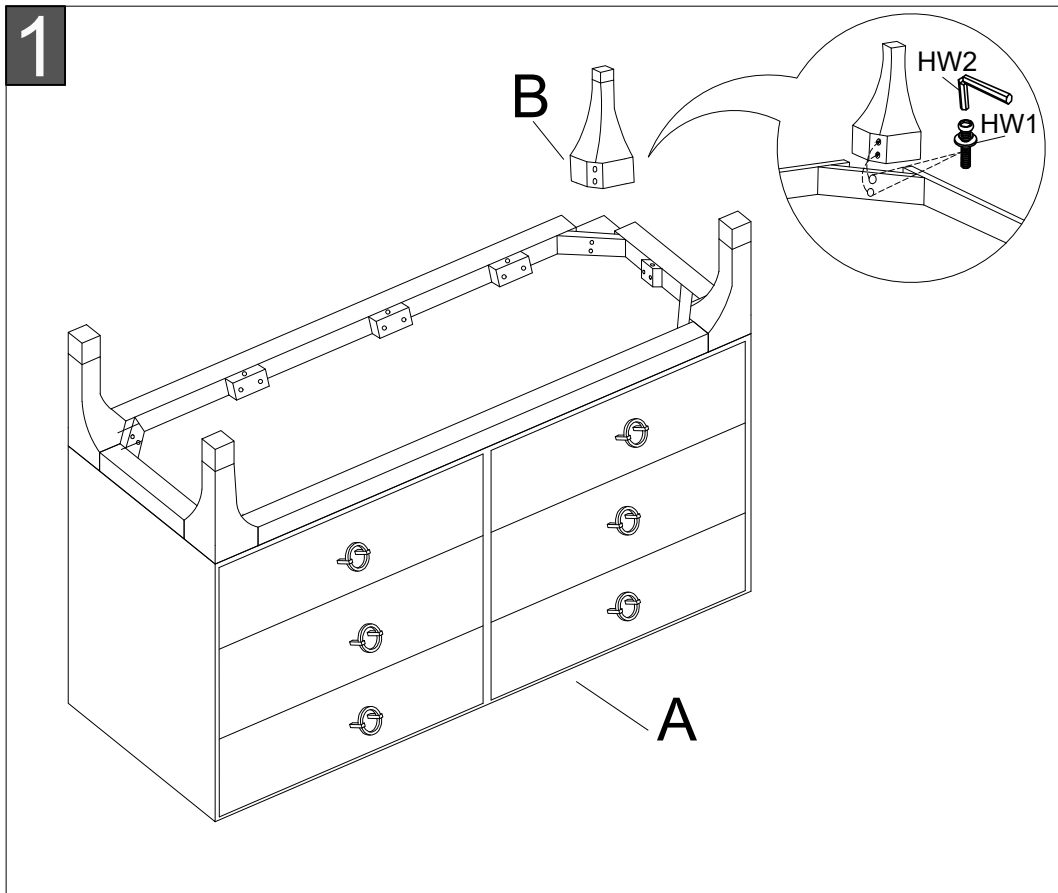

**Step 1:**  
Attach 4\*Leg (B) in the corresponding position on the underneath of drawer (A), by using Allen key (HW2) to lock with 8\*Allen bolt (HW1).

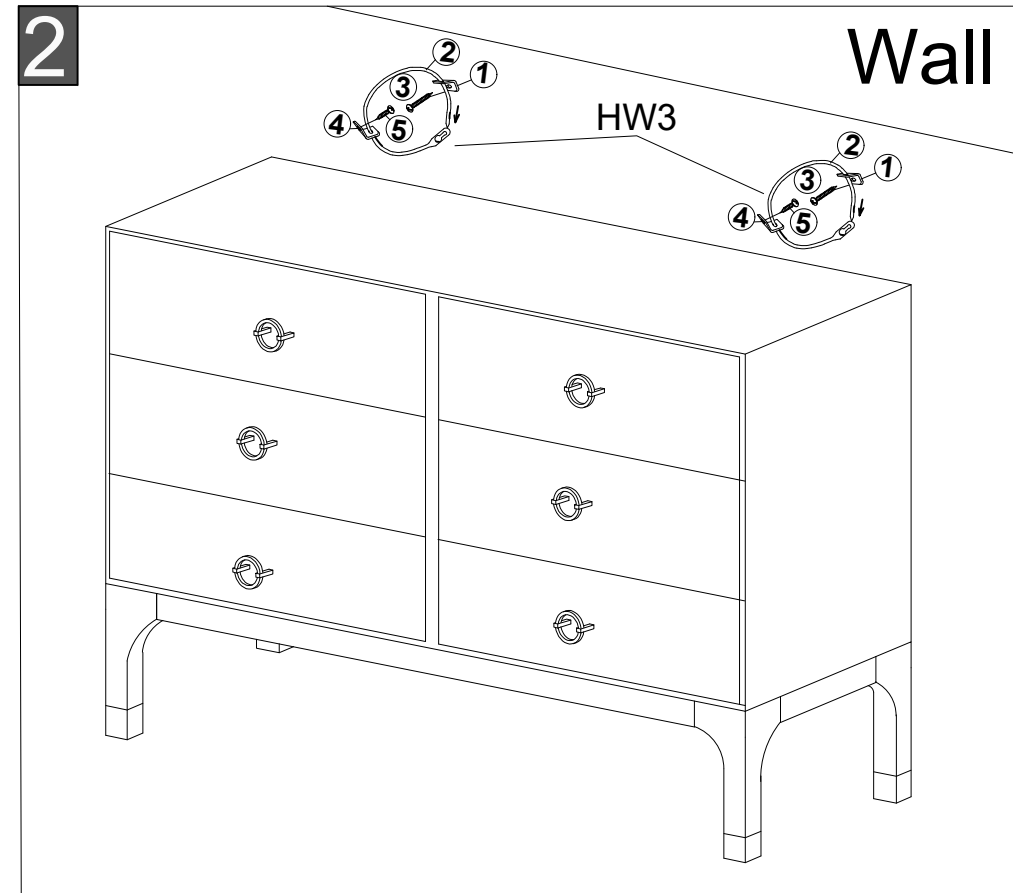

**Step 2:**  
Straighten up the assembled server. Following the installation instructions of anti-tipping (HW3) to fix the server in the wall by 2 straps. Assembly is completed.