

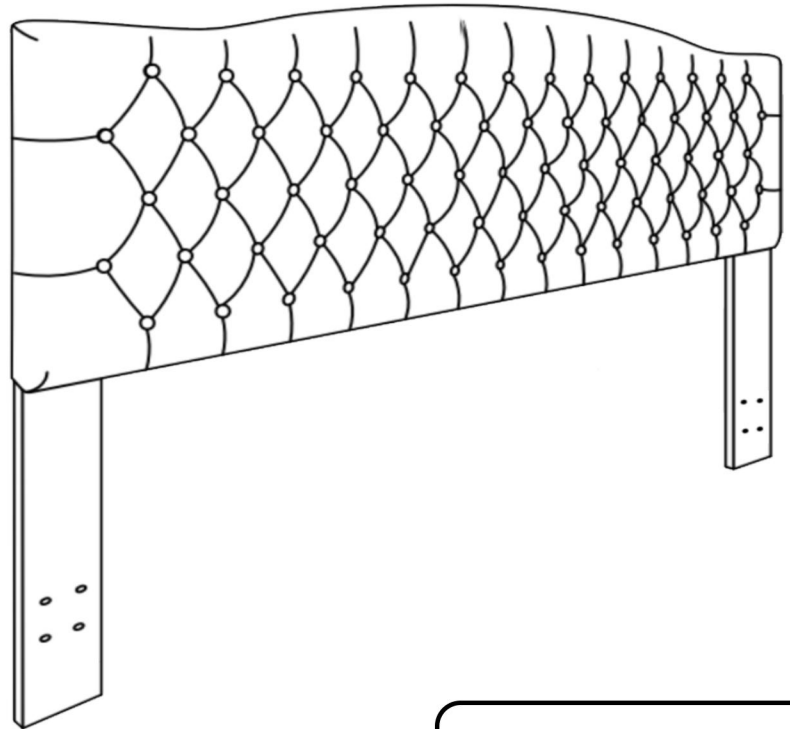







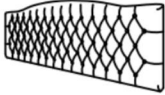

ASSEMBLY INSTRUCTIONS

For Bed Frame Attach

Caution:
Legs are
stored in
the back
zipper of
headboard!



Headboards-002

No.	ITEM	SKETCH	QTY
(A)	Bedhead		1pc
(B)	Right Leg		1pc
(C)	Left Leg		1pc
(D)	Allen Wrench M6		1pc
(E)	Allen Bolts øM8*1-3/8"		8pcs
(F)	Spring Washers ø5/16"		8pcs
(G)	Flat Washers ø5/16"		8pcs
(H)	Allen Bolts øM6*1-3/16"		4pcs
(I)	Allen Bolts øM6*2"		4pcs
(J)	Spring Washers ø1/4"		8pcs
(K)	Flat Washers ø1/4"		8pcs

We spare no effort to create high-quality and comfortable products for our customers. Please feel free to contact us if you need any help, Thank you.

Customer Service Email: help@mwbffurniture.com

Installation Guide:

1.Scan the QR below to view the installation guide



Velvet Fabric Maintenance Instructions*

Velvet fabric is prone to small scratches/lines during transportation and use.To easily recover,we recommend using an electric iron or hanging iron machine to gently iron and blow dry.

1

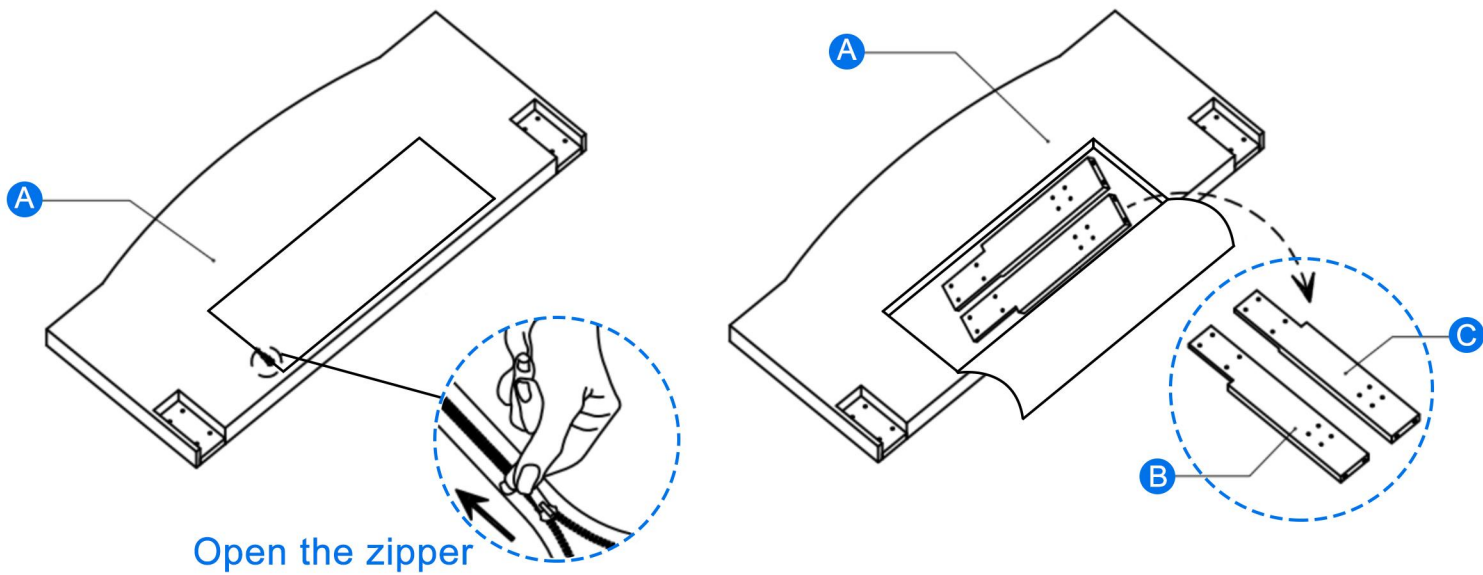

2

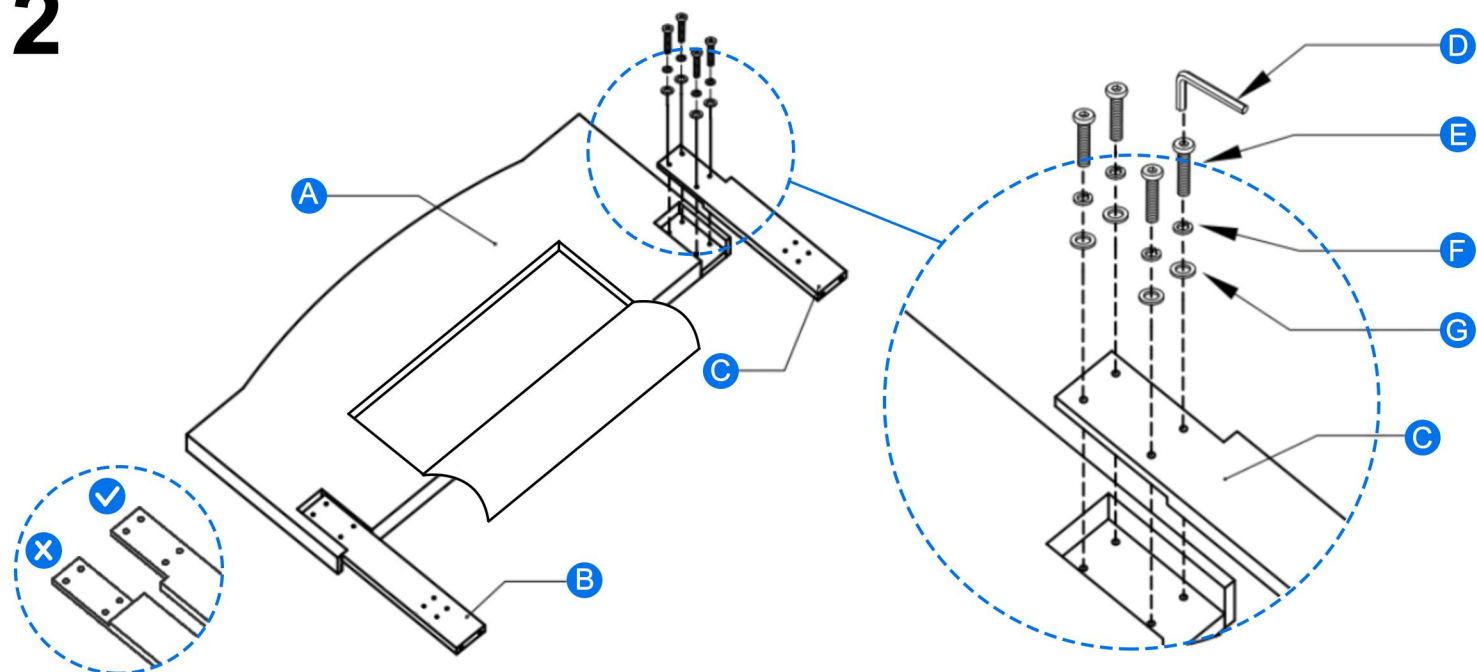

3 Adapt to different bed frames

