

# INSTRUCTION MANUAL

---

## Recliner Armchair

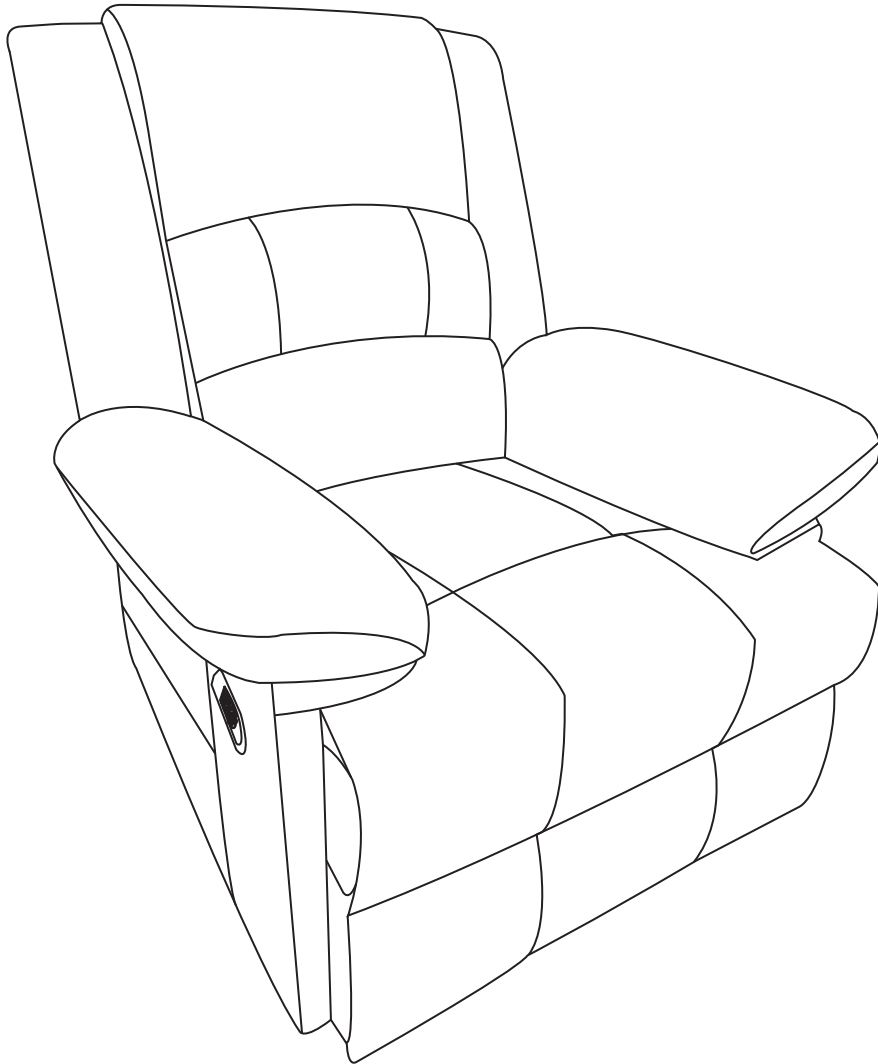

Customer Service Email: [reclinerfornewlife@yeah.net](mailto:reclinerfornewlife@yeah.net)









**NOTE**

1. The recliner is delivered in 2 parcels.
2. If you have any problems with installation or use, please contact us directly. Our customer service will enthusiastically provide you with solutions.

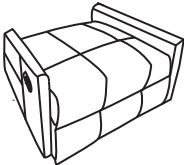
# CATALOG

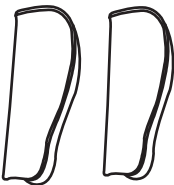
<b>Package list</b> .....	1
<b>Before Assembly</b> .....	2
<b>Important Safety Instructions</b> .....	2
<b>To store</b> .....	3
<b>To clean</b> .....	3
<b>Assemble Step 1-4</b> .....	4-7
<b>Recline the chair</b> .....	8
<b>Get the footrest latch down</b> .....	9
<b>Use remote control</b> .....	10
<b>Frequently Asked Questions</b> .....	11

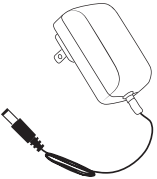
# Package list

Part		Qty	Part		Qty
<b>A</b>	<b>Chair base</b>	1PC	<b>B</b>	<b>Backrest</b>	1PC
					
<b>C</b>	<b>Backrest wings</b>	2PC	<b>D</b>	<b>Armrest cushions</b>	2PC
					
<b>E</b>	<b>Power cord</b>	1PC	<b>F</b>	<b>Remote control</b>	1PC
					

Note: The recliner is delivered in 2 parcels.

Please make sure you've got everything lists as following before assembly.

If not email us: [reclinerfornewlife@yeah.net](mailto:reclinerfornewlife@yeah.net)

## Before Assembly

Note: This massage sofa is delivered by 2 parcel. If you have any questions, please feel free to contact us at any time: [reclinerfornewlife@yeah.net](mailto:reclinerfornewlife@yeah.net)

- 1: Keep this instruction manual for future reference.
- 2: It is important to only use this product on a firm, level surface.
- 3: Keep all small parts out of reach of children and animals.
- 4: Make sure you have all the components, as listed in this instruction manual, if not, email us: [reclinerfornewlife@yeah.net](mailto:reclinerfornewlife@yeah.net)
- 5: Remove all packaging and place the components on top of the empty box or on a clean floor to prevent them from becoming scratched.
- 6: Make sure you have the right tools and a clean, dry and spacious area for assembly.
- 7: Assemble on a flat / firm surface to avoid damage.
- 8: Assemble in the room you intend to use the chair or as close as possible to that room.
- 9: Carefully follow each assembly step in the correct order to prevent incorrect assembly.
- 10: Before use, ensure that the product is fully assembled and only then should the screws and bolts be fully tightened but not over tightened.
- 11: Do not discard any packaging until the product is fully assembled. This will avoid disposing of any parts.
- 12: Do not use or attempt to assemble this product if parts are missing damaged or worn. Please email us: [reclinerfornewlife@yeah.net](mailto:reclinerfornewlife@yeah.net)
- 13: Place the product at a distance from the wall so that you can use the reclining function.

## Important Safety Instructions

- 1: If you have any concerns regarding your health, consult your doctor before using this product. Individuals with pacemakers should not use this product.
- 2: If you experience pain in a muscle or joint for a prolonged period of time discontinue use and consult your doctor.
- 3: Persistent pain could be a symptom of a more serious condition.

When using an electrical appliance, basic precautions should always be followed including the following:

- 1: This product is for use on a 12V circuit. Make sure that the product is connected to an outlet having the same configuration as the plug.
- 2: Always unplug the massager from the power source after use, and before cleaning.
- 3: Do not reach for massager if it has fallen into water. Unplug immediately.
- 4: An appliance should never be left unattended when plugged in. Unplug from outlet when not in use, before putting on or taking off parts or attachments.
- 5: Do not use outdoors.
- 6: Do not carry this appliance by supplied cord as a handle.
- 7: Keep the cord away from heated surfaces.
- 8: Close supervision is necessary when this appliance is used by or near children, invalids or disabled persons.
- 9: This unit is not a toy. Children should not use it or play with it.
- 10: Do not operate where aerosol (spray) products are being used or where oxygen is being administered.
- 11: Do not use near eyes or other highly sensitive areas.
- 12: Keep cord away from heated surfaces.
- 13: Use this appliance only for its intended use as described in this manual. Do not use attachments not provided with the unit.

### To store

- 1: Place unit in its box or safe, dry, cool place. Avoid contact with sharp edges or pointed objects which might cut or puncture the fabric. Do not wrap power cord around the unit.
- 2: Do not hang the unit by power cord.

### To clean

- 1: Insure the unit is unplugged from the power source, and allow to cool before cleaning.
- 2: Do not place in any liquid to clean. Clean fabric cover by wiping with a damp sponge, using a mild detergent or suds. Pat dry with clean, dry cloth.
- 3: Do not use abrasive cleaners, brushes, gasoline, kerosene, glass / furniture polish, paint thinner or water hotter than 120 °C to clean the unit.
- 4: To clean the unit, make sure the massager is unplugged. Allow the unit to cool and the wipe down with a damp clean cloth. Do not use any strong chemical cleaners.

# STEP 1

Zip up the armrest cushions (D) and the chair base (A) to ensure that both armrest cushions are well secured to the armrests.

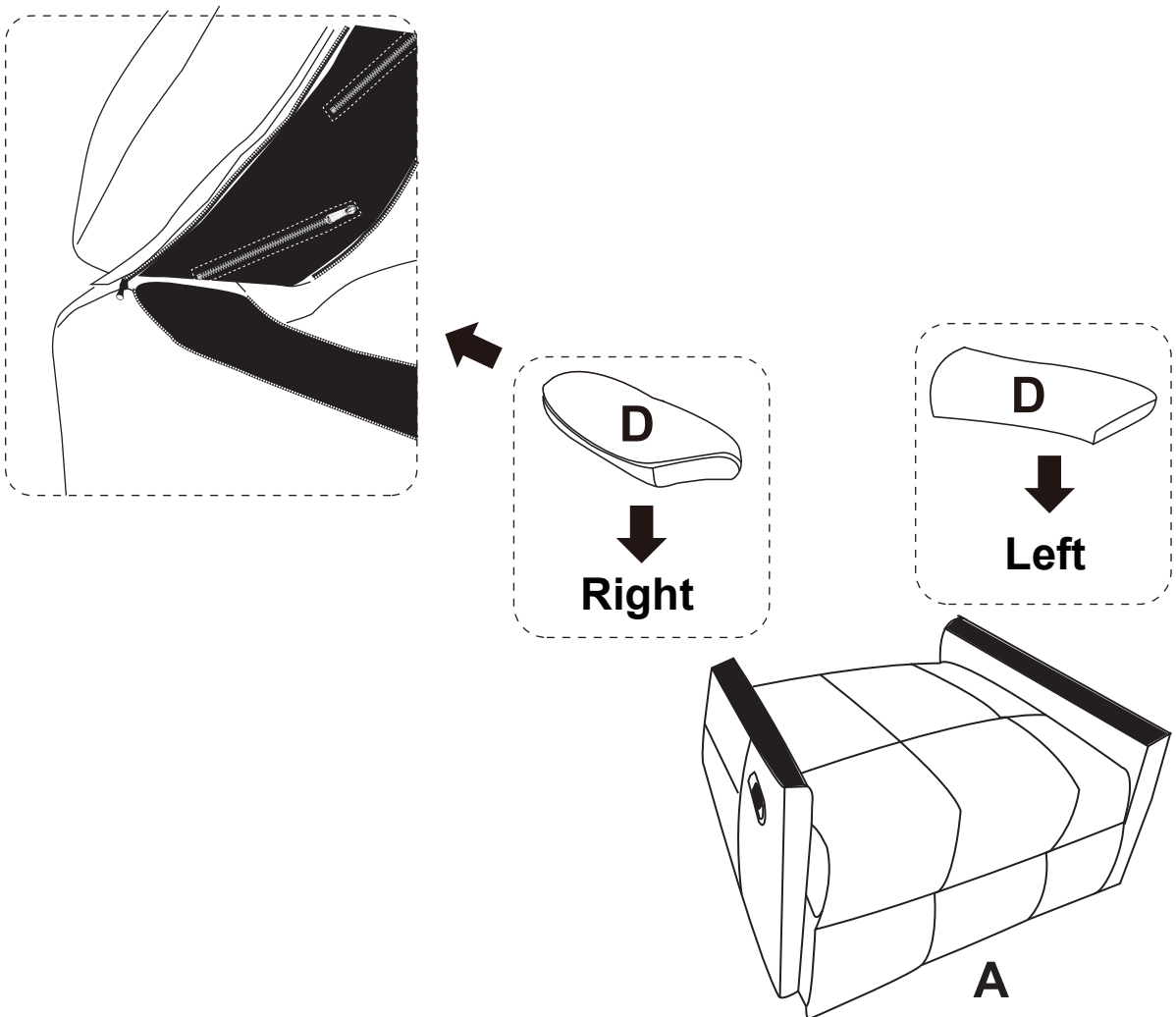

## STEP 2

Insert the recliner backrest (B) into the chair base (A), and make sure the slots on the back are fully assembled to the bottom part.

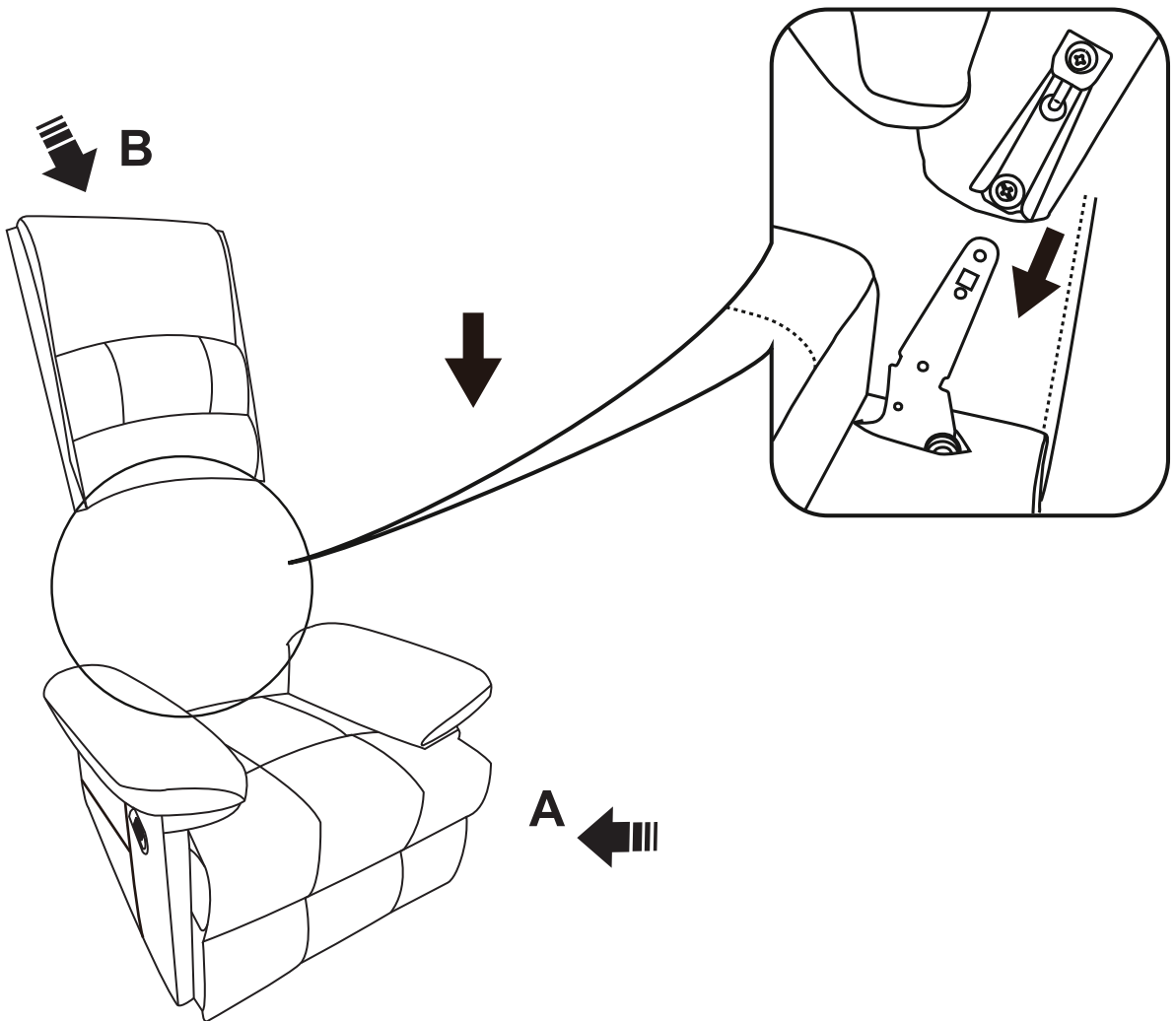

# STEP 3

Insert the backrest wings (C) into the recliner backrest (B), and make sure the slots in the backrest are fully assembled with the backrest wings

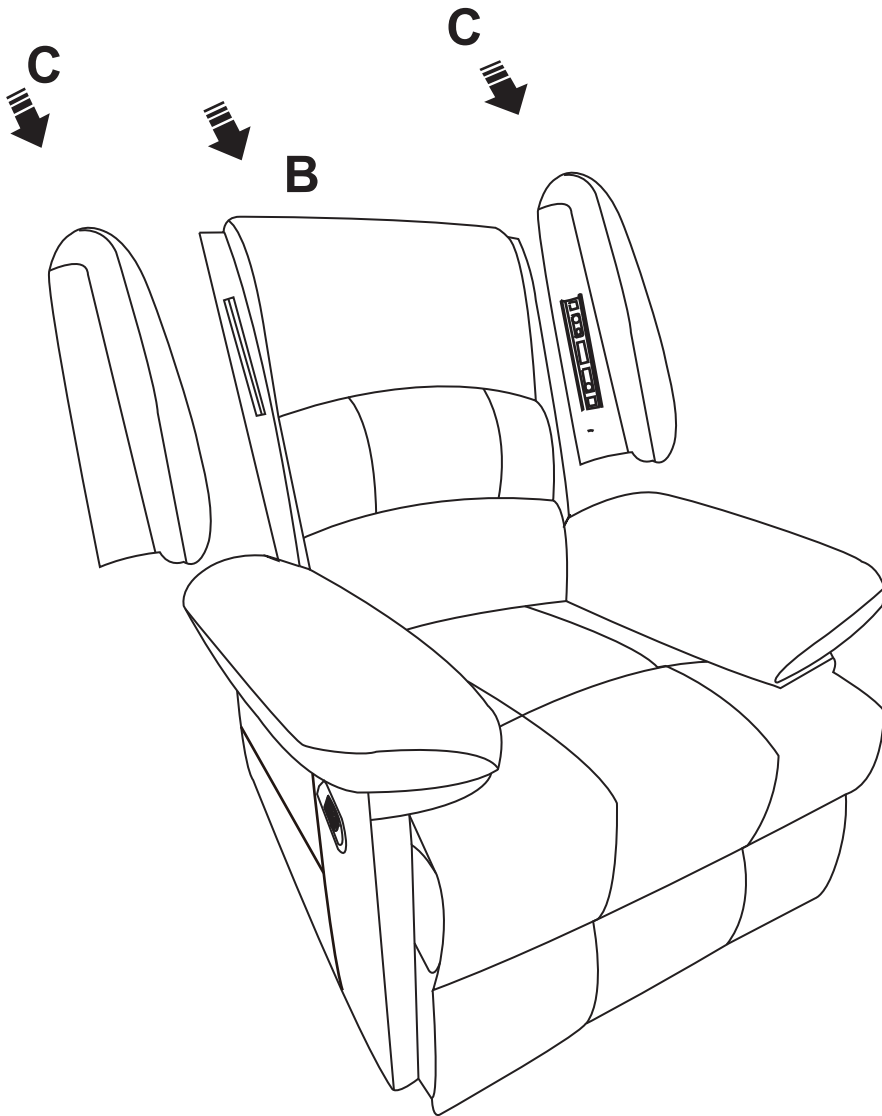

# STEP 4

No.1 and No.2 wires connect with the backrest and chair base.  
No.3 wire connects with the backrest and power cord (E).  
No.4 wire connects with backrest and remote control (F).

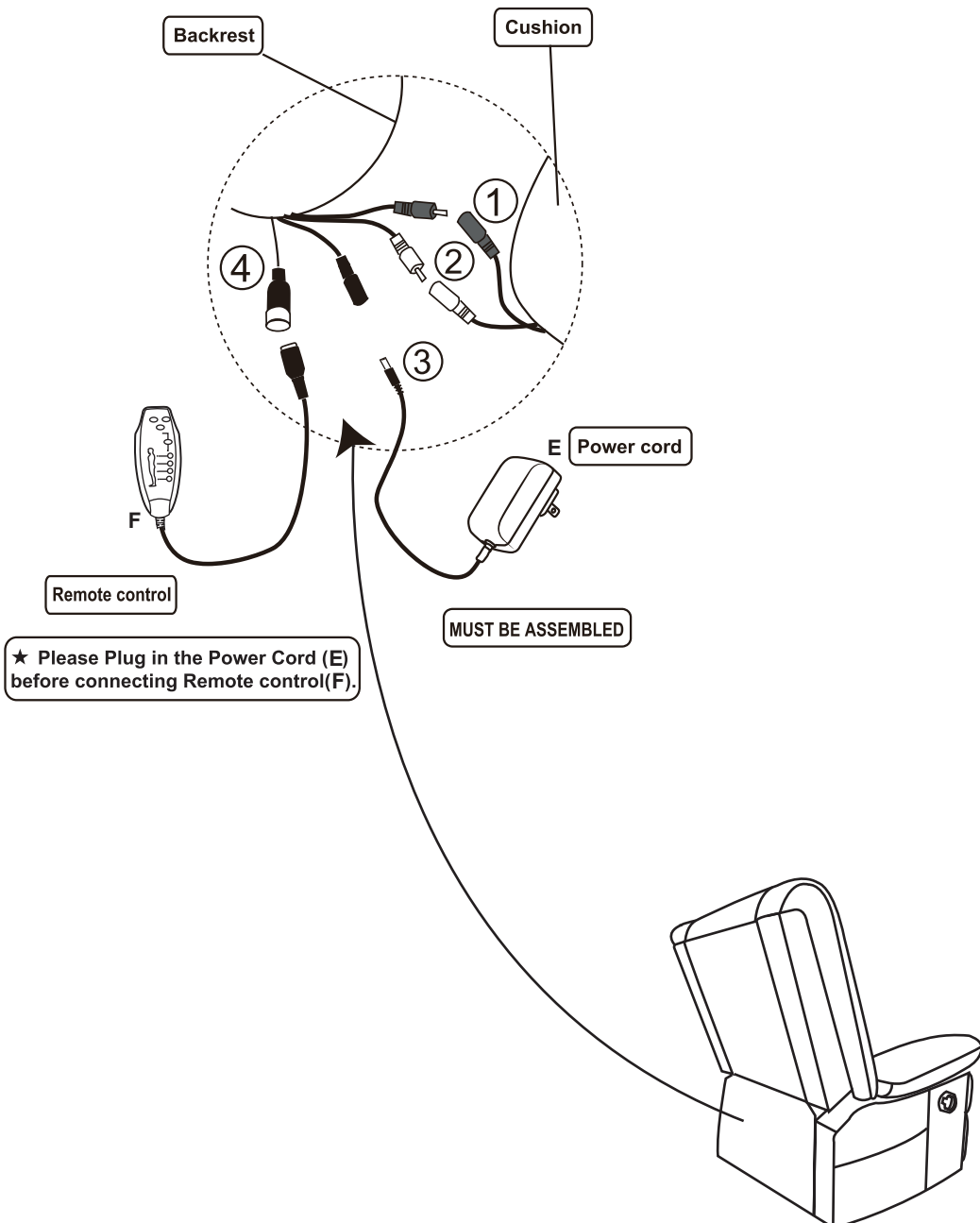

# How to recline?

1. Pull the handle on the right side to release the footrest.

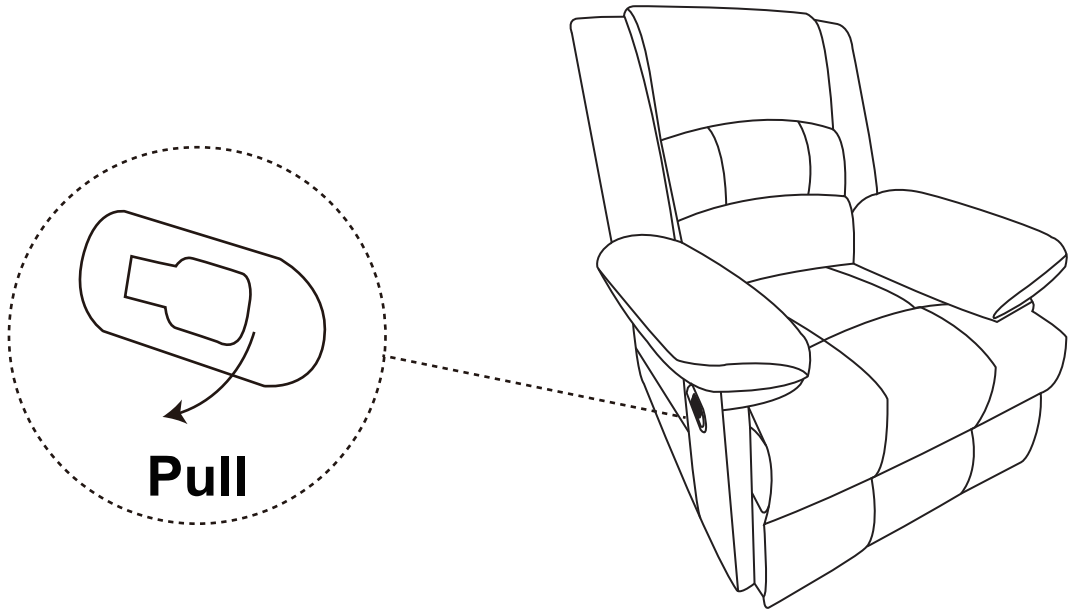

2. Sit deeper in the chair, put your hands on the armrests, lie down, and use both hands and back strength to recline.

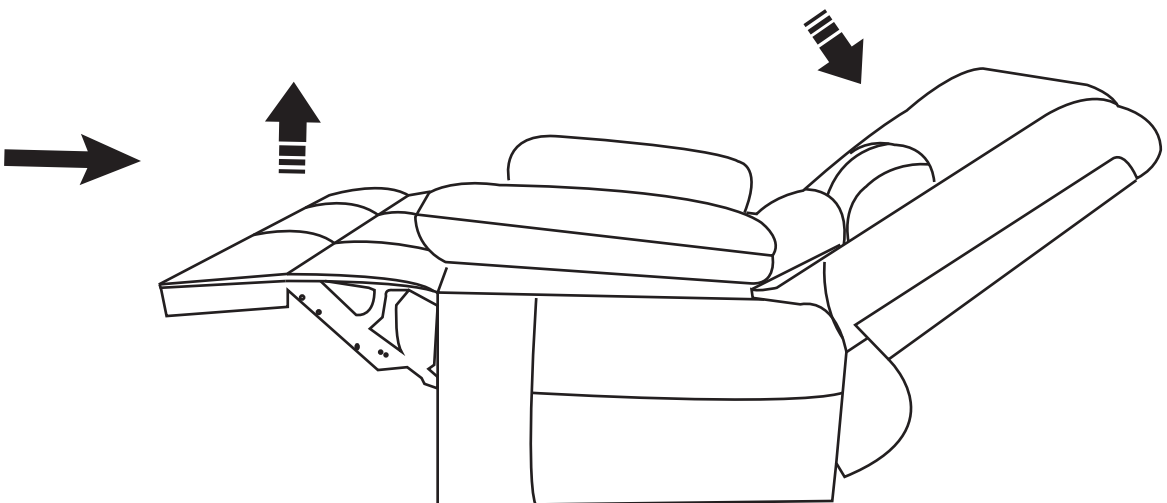

# How to get footrest latch down?

**Sit on the chair**

**(not recline, the backrest will be back)**

**Press the bottom of the footrest quickly with some strength (with feet) and try times to get the footrest latch down.**

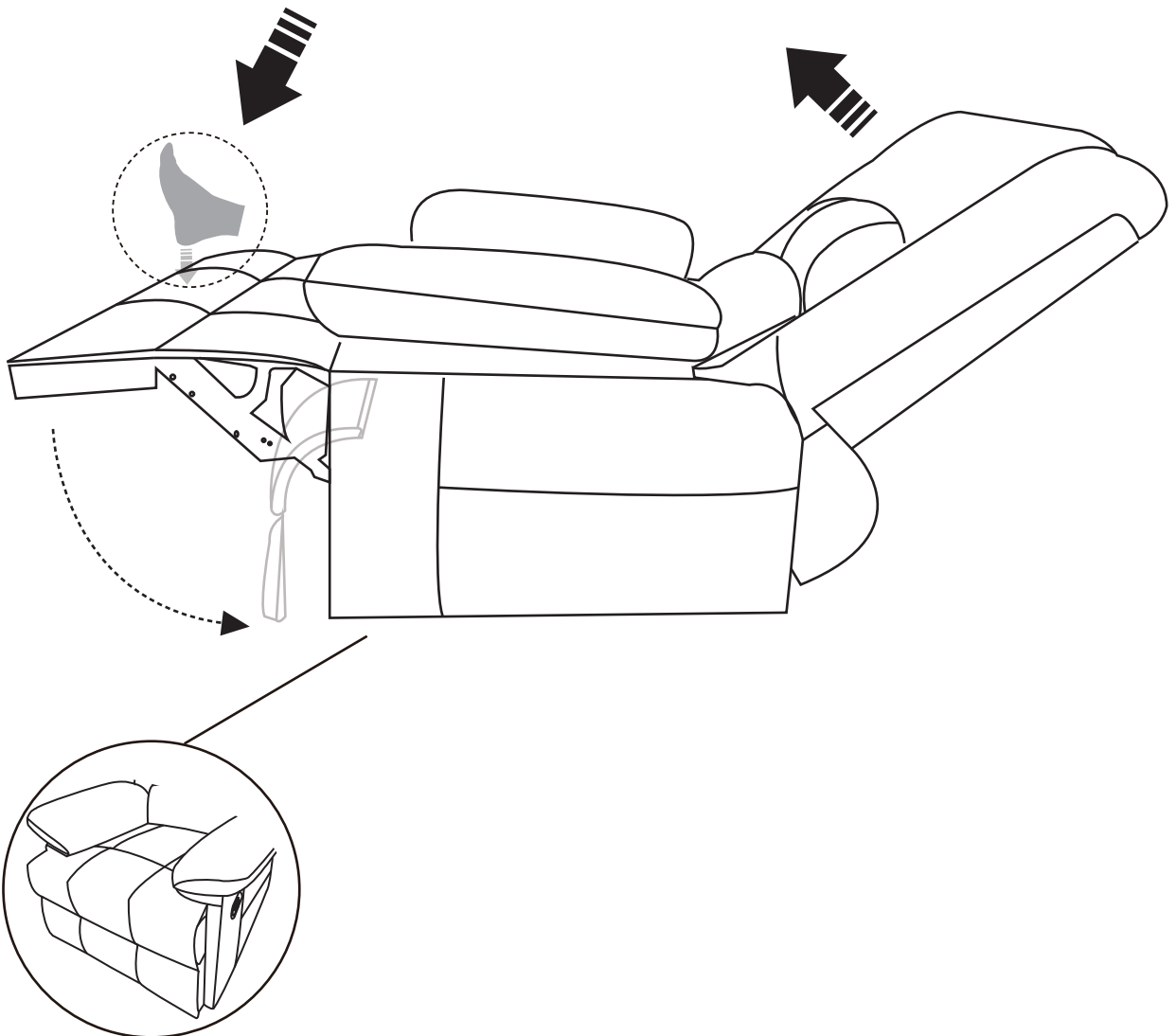

# How to use remote control?

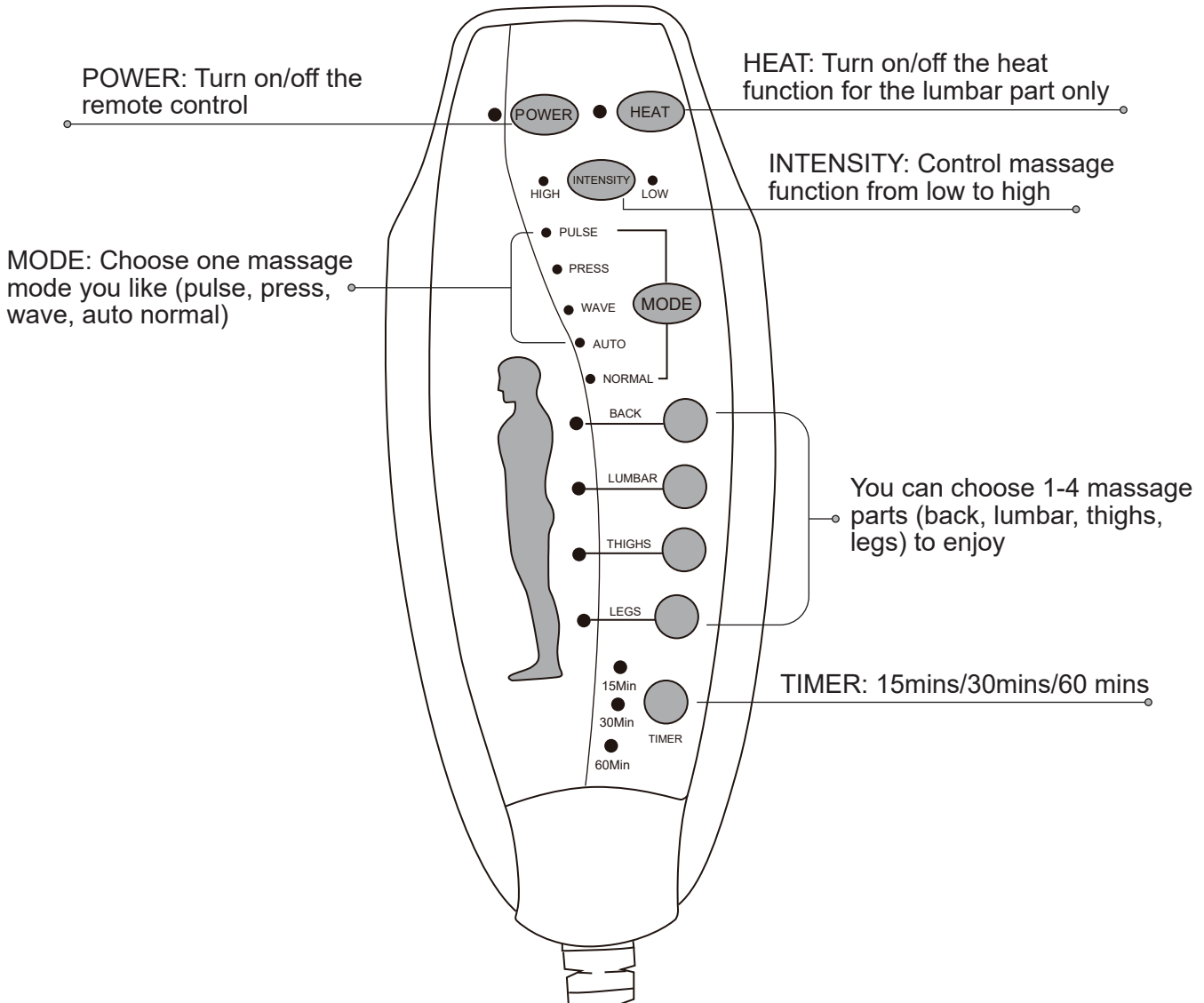

## ⚠ NOTE

- 1: When the time you choose is reached, it will automatically stop working.
- 2: DO NOT use for more than 60 minutes of continuous use.
- 3: When the heat reaches 60°C, it will automatically stop working.
- 4: When using the rotation function, be careful not to get tangled with the power cord of the remote control.

# Frequently Asked Questions

**Q1: Missing parts when receiving.**

**A: If you find some parts are missing from the box, please send to our after-sales email ([reclinerfornewlife@yeah.net](mailto:reclinerfornewlife@yeah.net)) to let us know the name of the missing part in relation to the first page of instructions. We will send you the replacement as soon as possible.**

**Q2: Some parts were damaged on arrival.**

**A: Please send us clear photos of the damaged part as an attachment, we will check and offer you the best solution as soon as possible.**

**Q3: The chair is stuck in the reclining position and does not respond when I pull the handle.**

**A: Please contact us and send clear photos or videos of the damage to our after-sales email ([reclinerfornewlife@yeah.net](mailto:reclinerfornewlife@yeah.net)), and we will offer you the best solution as soon as possible.**

**Q4: What is weight limit?**

**A: 265LBS/120KG**

**Q5: Stopped working!**

**A: When the time you choose is reached, it will automatically stop working.**

**A: When the heat reaches 60°C, it will automatically stop working.**

**A: Ensure the external transformer is plugged into a properly wired electrical outlet.**

**A: Check the circuit breaker box connected to the electrical outlet to ensure the outlet is receiving power.**

UK REP

Name: Sea&Mew Accounting Ltd  
Address: Electric Avenue Vision 25, London,  
Enfield, EN3 7GD  
Contact Person: Billy Han  
E-mail: [info@seamew.net](mailto:info@seamew.net)  
Tel: +44 7399648608

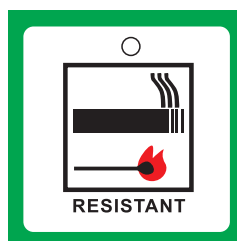

Filling material(s) and covering fabric(s) meet the requirements for resistance to cigarette and match ignition in the Furniture and Furnishings(Fire)(Safety) Regulations 1988

**CARELESSNESS  
CAUSES FIRE**

