

Recliner Sofa

Model

Loveseat Recliner

(2 Boxes Refer to pages 1-9)

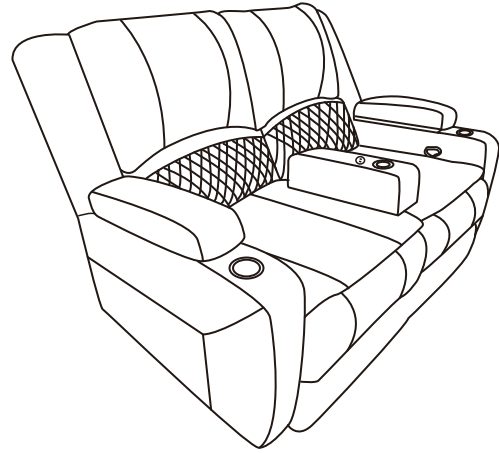

Recliner Sofa

With Removable Console

(3 Boxes Refer to pages 10-20)

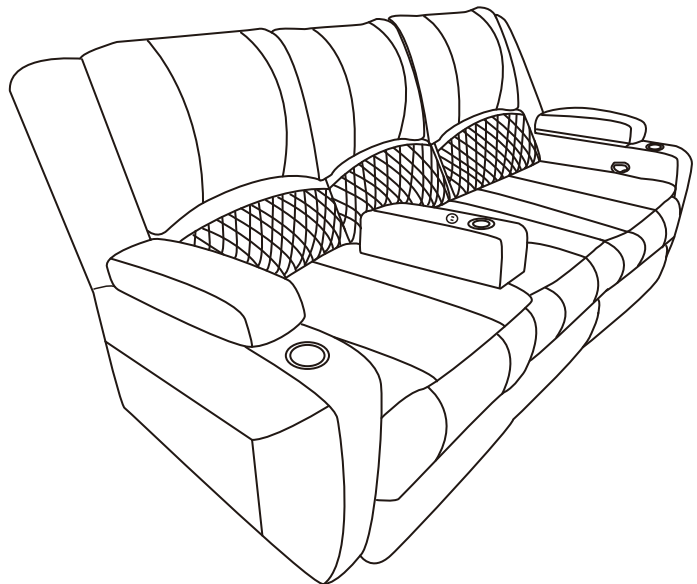

(Note:

1. This is a universal instruction, please refer to the corresponding page according to the model you purchased.

2. If you have any questions after receiving the sofa, please contact us in time and provide pictures. We will try our best to help you solve it.

Loveseat Recliner

Operating instruction

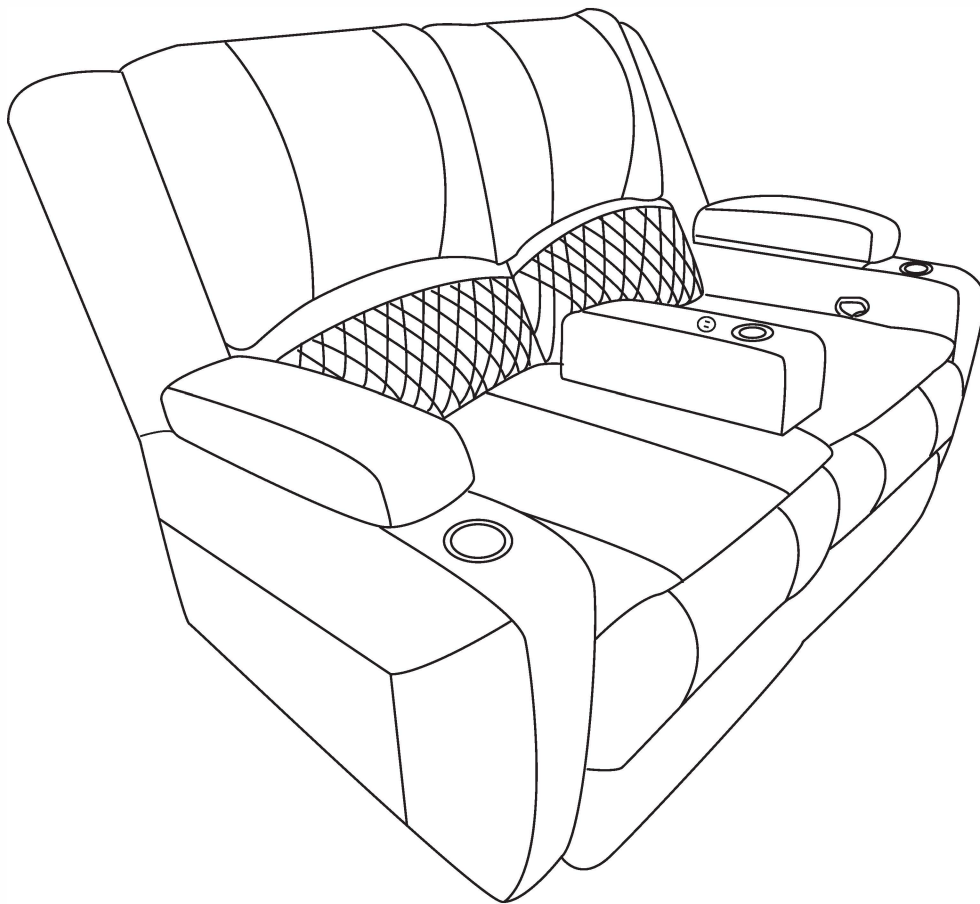

NOTE 1: This sofa is shipped in 2 box . All accessories included. If you have any questions after receiving the recliner. Please contact us in time and provide pictures. We will try our best to help you solve it.

WARRANTY

So glad you have completed the assembly and can enjoy it. If you are satisfied with our products, thank you for showing your favored recliner to your around.

The quality of our furnitures has been strictly controlled. Each stage of the product upgrading has condensed the efforts of employees in various departments. We strive to minimize the probability of failure of new products and insist on providing customers with worthless after-sales service.

AFTER-SALE POLICY

For return reason:

Wrong purchase, bought by mistake, no longer needed, doesn't meet expectation, a size smaller than expectation, customer need to cover the return shipping fee.

For cancel order:

Customer needs to pay for shipping fee and carrier handle fee if the item has been shipped out.

For change address:

Customer needs to pay for extra shipping fee and carrier handle fee if the item has been shipped out.

Customer Service: Any problem with the product or shipping issue, please feel free to contact us, we will try our best to serve and help.











ATTENTION

Enjoyable time on recliner is coming after 15 minutes of installation!

















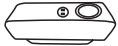

- 1. Please check the manual carefully and make sure you have received all the parts.**
- 2. If there is any missing parts, please let us know the letter of the parts you need.**
- 3. If there is any damage parts, please send clear photos to us, we will check and offer you best solution soon.**

Please check if the accessories parts are completely received according to the letter labels and quantity below

BOX-A







Part		Qty	Part		Qty
A1		1PC	B1		1PC
C1		1PC	D1		1PC
E1		1PC	F1		1PC
G1		1PC	H1		1PC
I1		1PC	J1		1PC

BOX-B

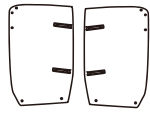
Part		Qty	Part		Qty
A2		1PC	B2		1PC
C2		1PC	D2		1PC
E2		1PC	F2		1PC
G2		1PC	H2		1PC
I2		1PC	J2		1PC
K		1PC	L		1PC
M		24PCS	3		8pcs
4		4pcs	5		8pcs
6		2pcs	7		1pcs

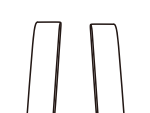
Step 1. Assemble Chair Arm Frames

Let's start to assemble the Left Chair Arm Frame first, we named it N1 group
Please find and prepared those pieces with Labels: C1,D1,E1,F1,G1 and M

Label	Accessory Shape Reference	N1: Left Chair Arm N2:Right Chair Arm	
C1,C2		C1: Right side board of Left Arm	C2: Left Side Board of Right Arm
D1,D2		D1: Left side board of Left Arm	D2: Right Side Board of Right Arm
E1,E2		E1: Front Block of Left Arm	E2: Front Block of Right Arm
F1,F2		F1: Back Block of Left Arm	F2: Back Block of Right Arm
G1,G2		G1: Left cupholder frame	G2: Right cupholder frame
M		Screws Pack	

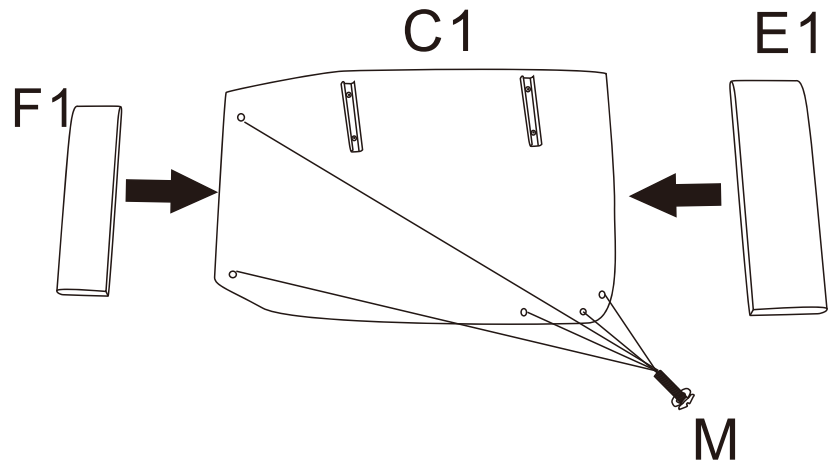

Fix E1 block and F1 block with screws to C1 board (side without the metal buckle)

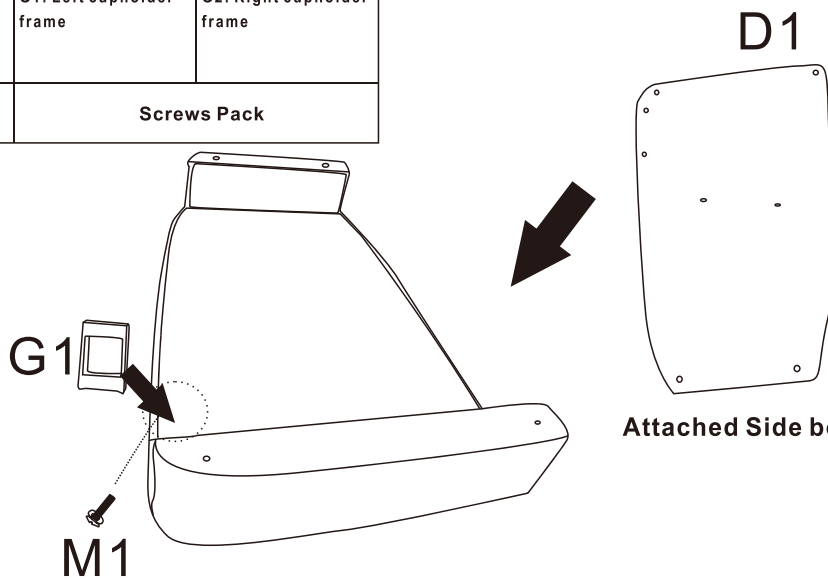

Attached Side board D1 to E1 and F1 with screws



Fix cupholder G1 with screws to the border position(as picture) by attaching to C1 and D1)

Please find and prepared those pieces with Labels: C2,D2,E2,F2,G2 and M to assemble the Right Chair Arm with the same way. We named the Right Arm as N2 group

Step 2. Finishe Chair Arms

Put the Left cover pillow (H1) to the Left chair arm frame(Assembled in step1);

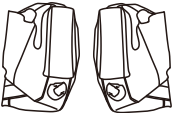
Note: the cupholder place should aim at the cupholder frame, make sure the cover is tension and smooth.

Label	Accessory Shape Reference	Name
H1 , H2		H1: Left Chair Am Cover Pillow H2: Right Chair Am Cover Pillow
M		Screws Pack

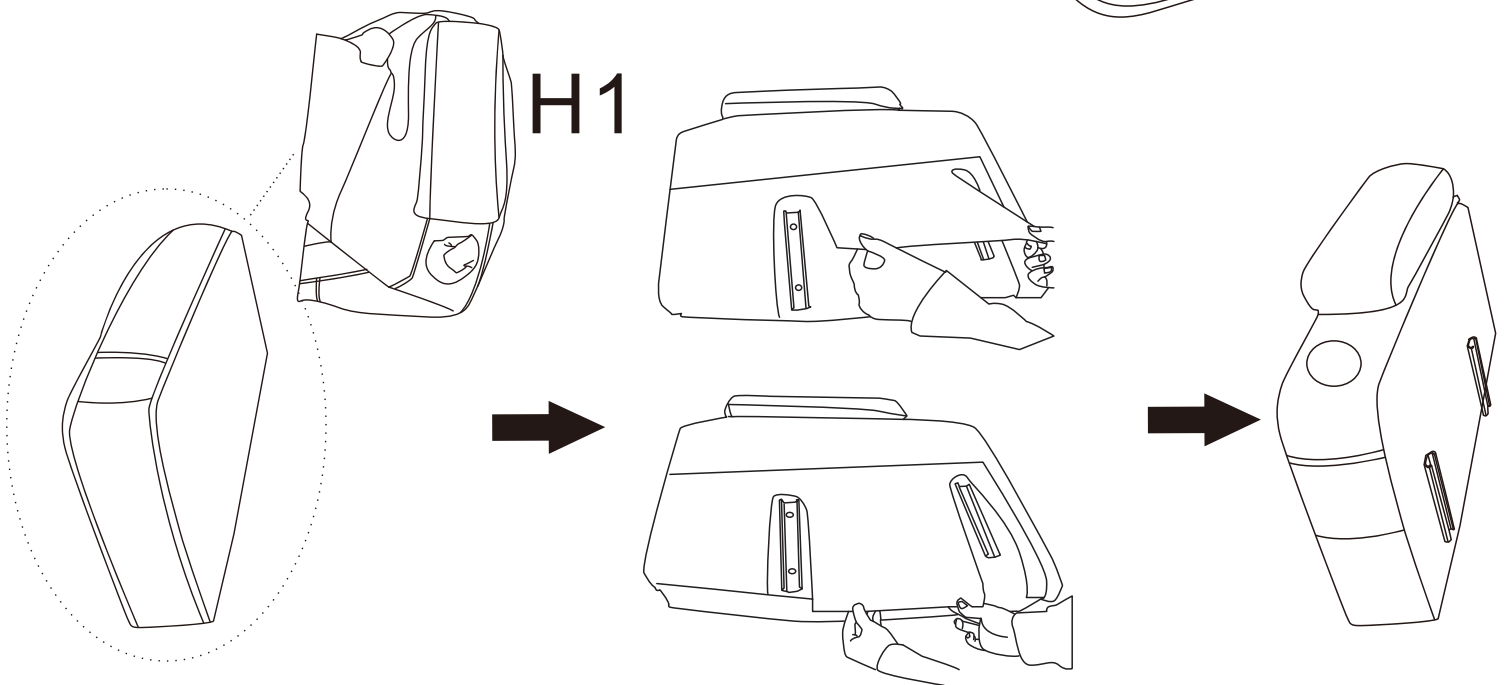
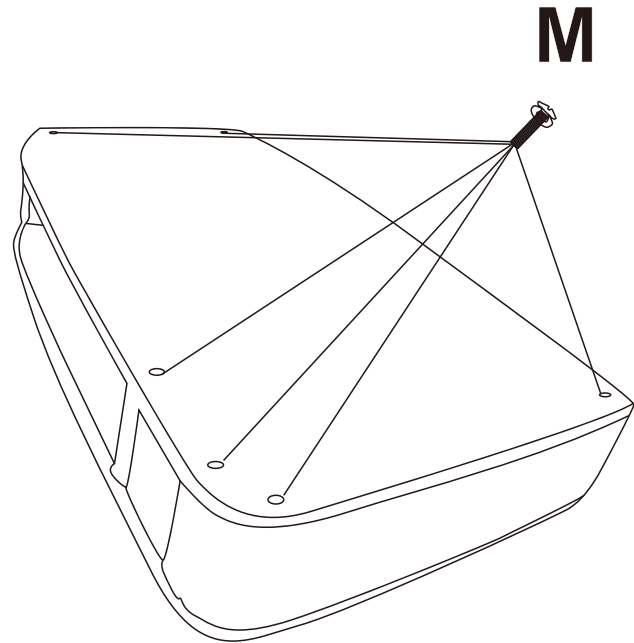

Then do the same as to right side(H2)

Step 3

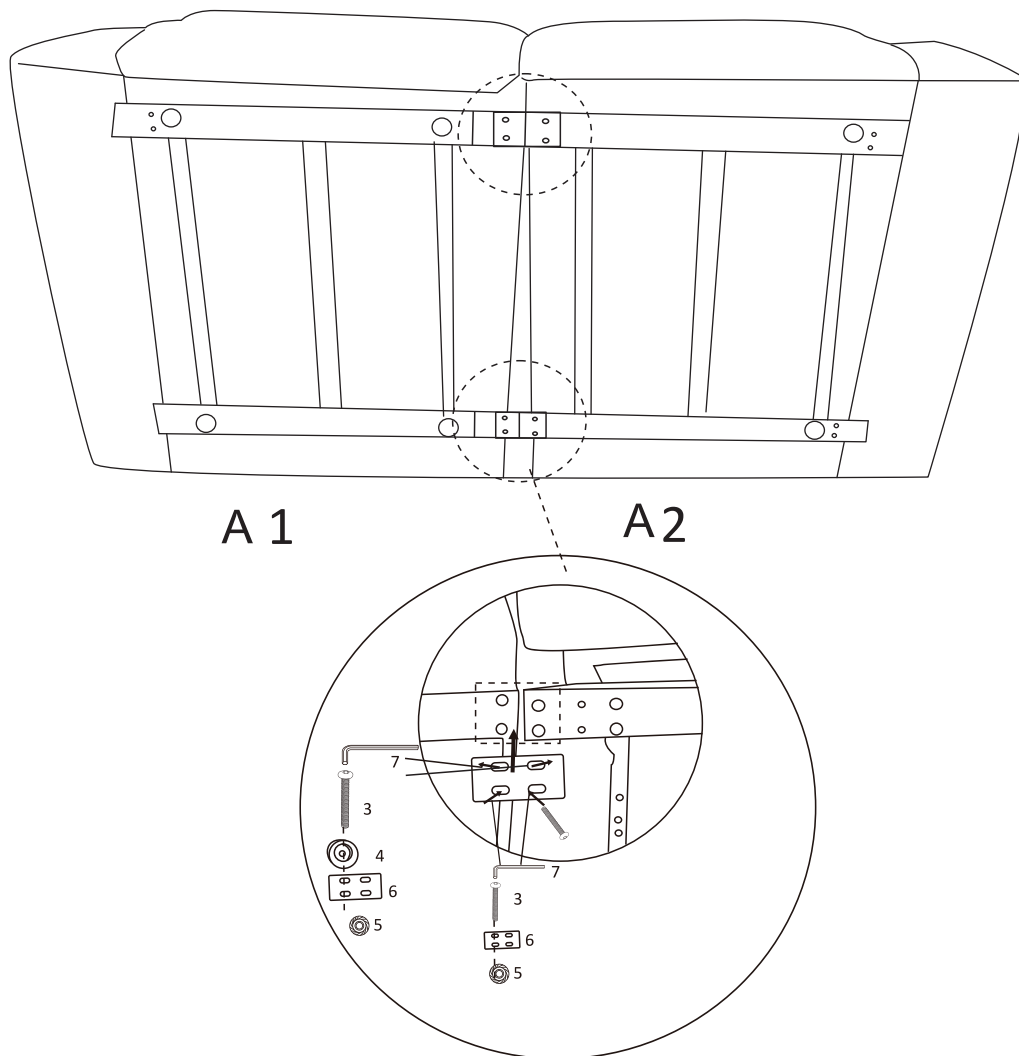

Accessories: Part 3*4 Part 4*4 Part 5*8 Part 6*2 Part 7*1

Operating Procedure:

Connect the Part A1/A2 by using the Part 6. For the convenience to adjust parts connection, never fully tighten the screws until you finish the installation, tighten screws to 80%-90% is enough.

*** Mounting two parts 4 horizontally side by side is more stable.**

Step 4. Attached the Chair Arm

2 or More adults would be easier to assemble the chair.

① Put the seat pad (A) on the ground, attaching N1 (Left Arm) to seat pad, by inserting the 2 metal pegs of seat pad into the clips of the Left Arms.

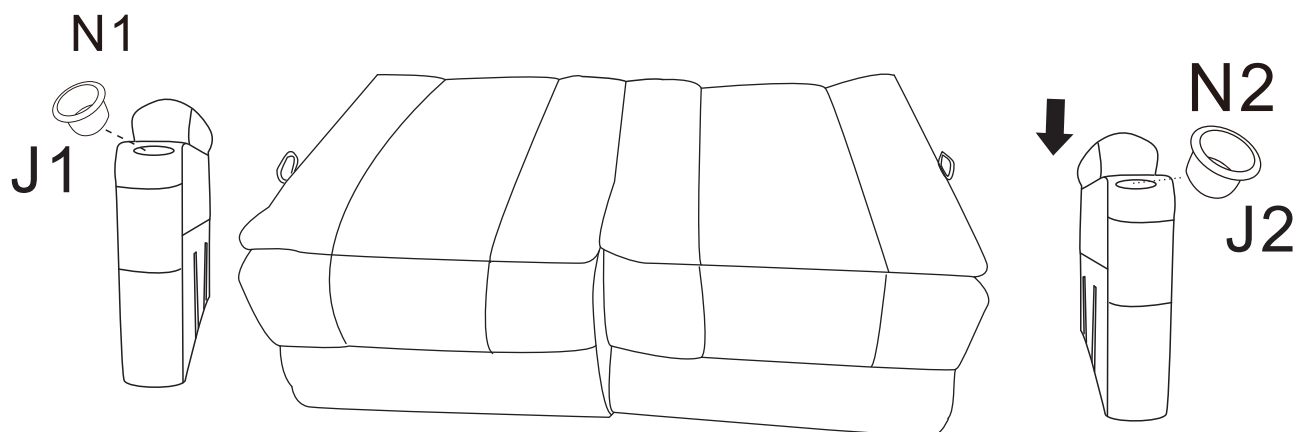

2 or More adults would be easier to assemble the chair.

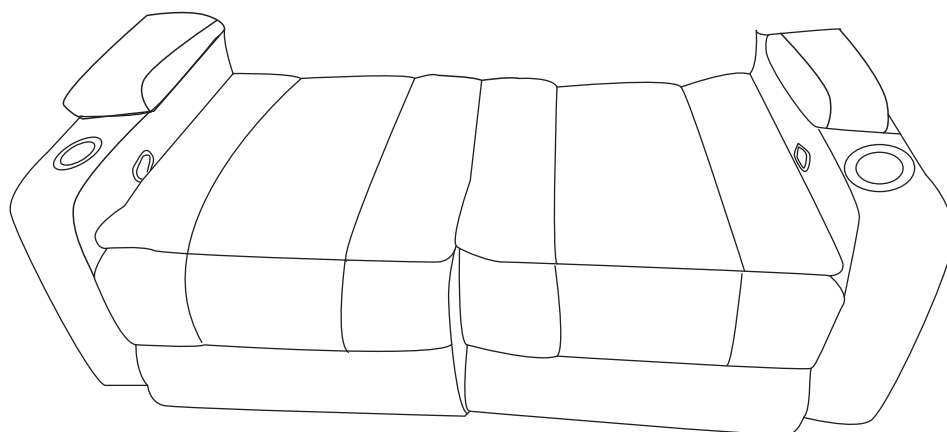

Please do the same to assemble the Right Arm.

Step 5. Assemble the backrest

- ① Attaching the Part B (Backrest) to the seat pad, by inserting the metal pegs of seat pad into the slots of the Backrest.
- ② Attach the 2 backrest wings (I1 and I2 as picture) to the backrest B with the same way.

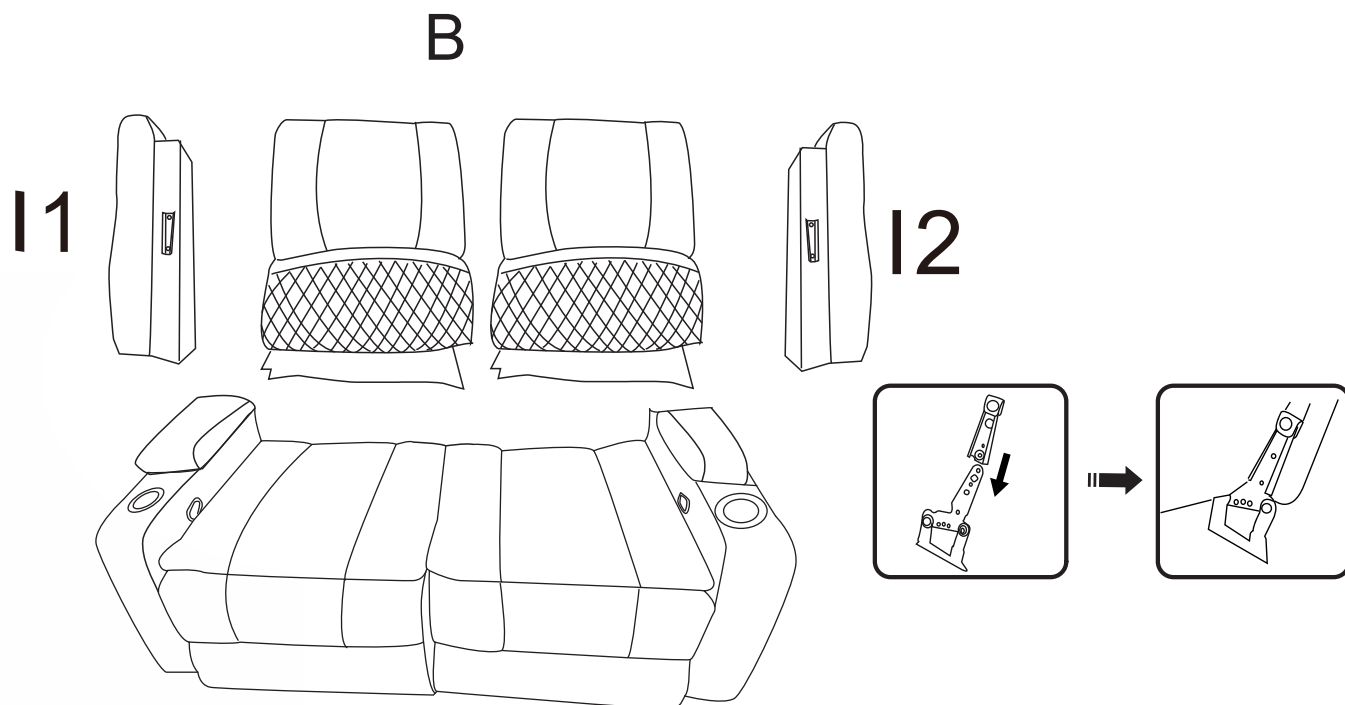

Accessories:

I1: Left backrest wings

I2: Right backrest wings

Step 6

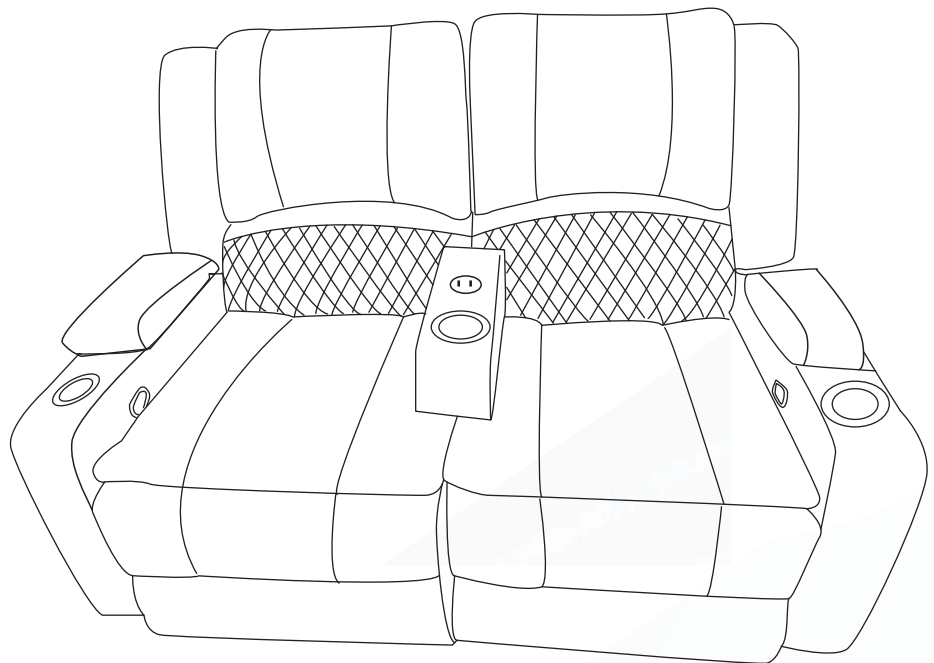
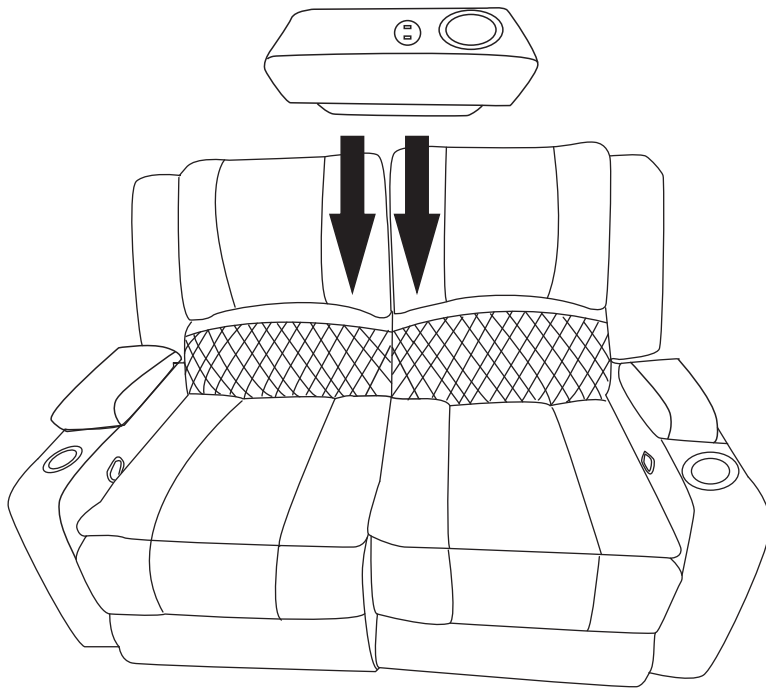

Step 7 . Enjoy the comfortable

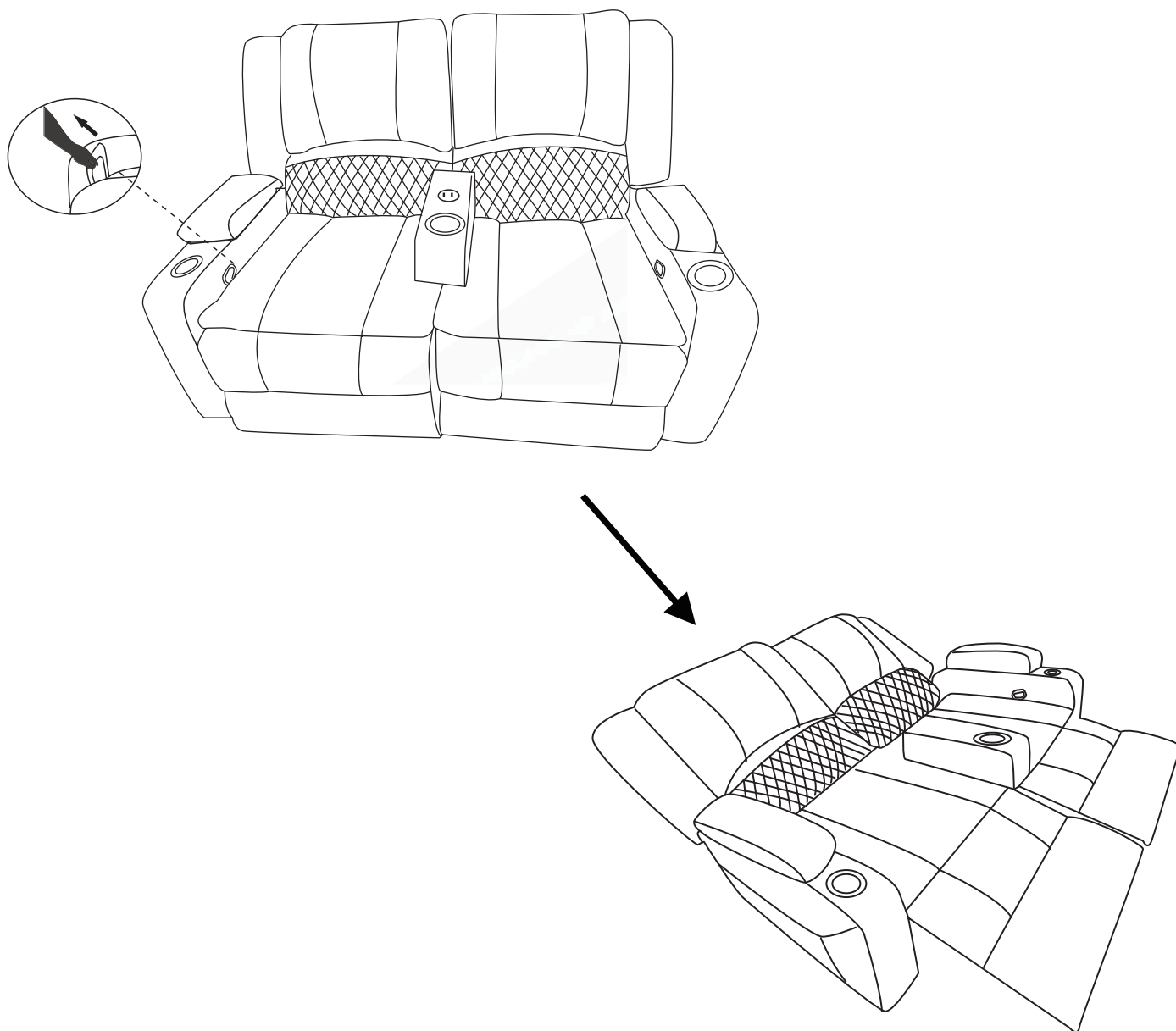

Sit down and pull the handle on right side, then the footrest raise up; move body backwards a little bit and with your own gravity to recline, enjoy the comfortable.

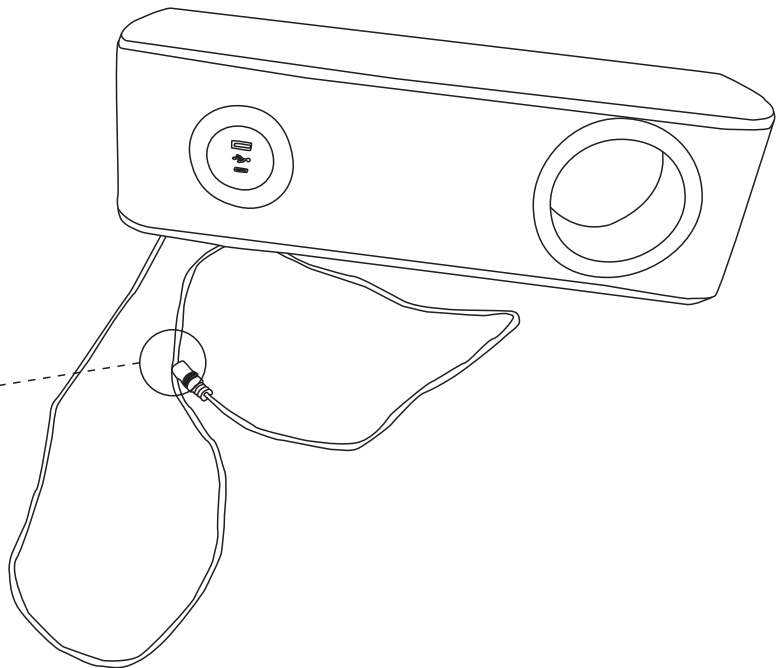
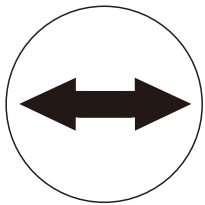
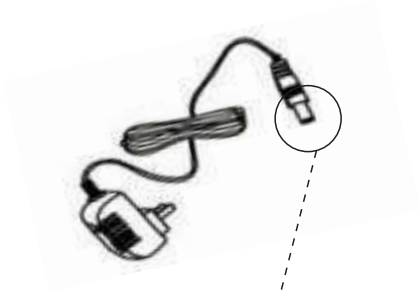
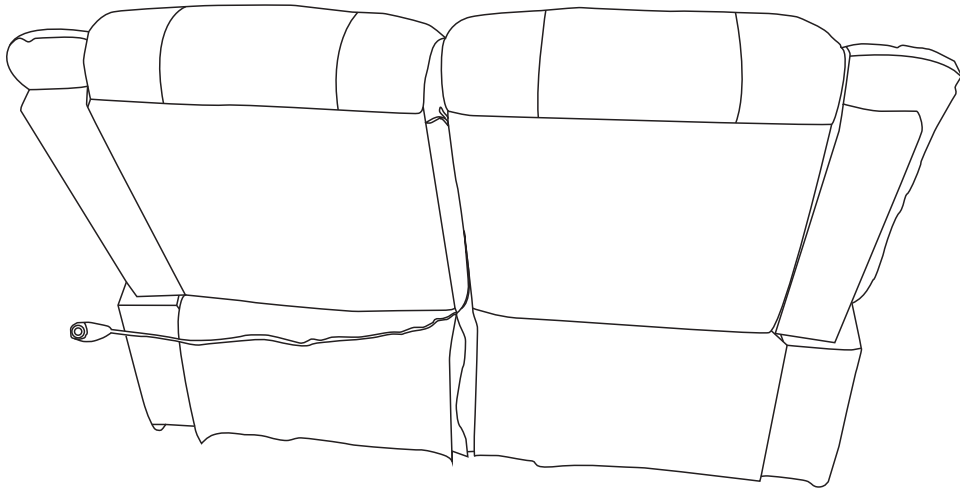

Loveseat Recliner



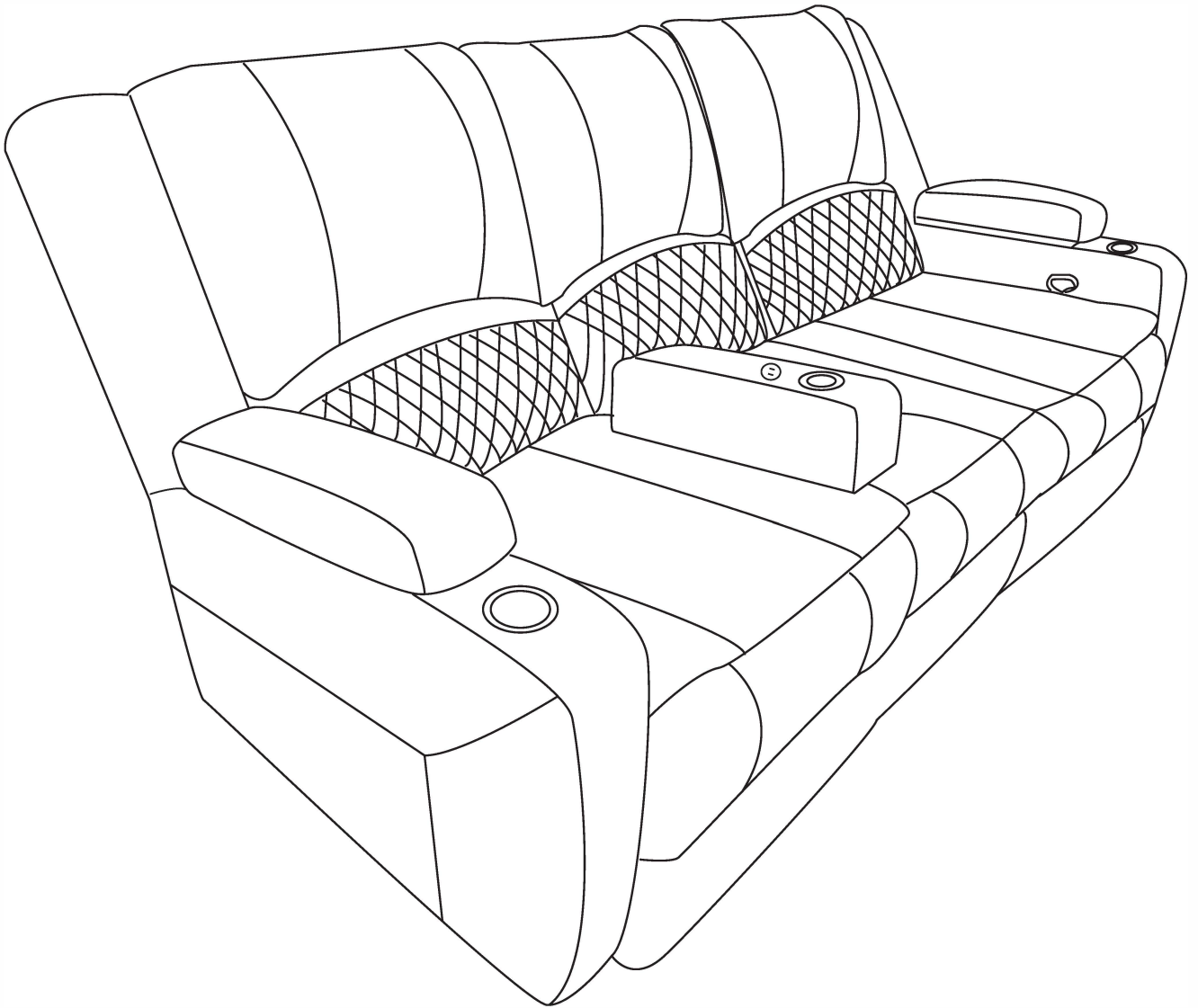







Operating instruction



















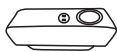

NOTE 1: This sofa is shipped in 2 box . All accessories included. If you have any questions after receiving the recliner. Please contact us in time and provide pictures. We will try our best to help you solve it.

Please check if the accessories parts are completely received according to the letter labels and quantity below

BOX-A





Part		Qty	Part		Qty
A1		1PC	B1		1PC
C1		1PC	D1		1PC
E1		1PC	F1		1PC
G1		1PC	H1		1PC
I1		1PC	J1		1PC

BOX-B

Part		Qty	Part		Qty
A2		1PC	B2		1PC
C2		1PC	D2		1PC
E2		1PC	F2		1PC
G2		1PC	H2		1PC
I2		1PC	J2		1PC
K		1PC	L		1PC
M		24PCS	3		8pcs
4		4pcs	5		8pcs
6		2pcs	7		1pcs



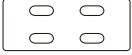

Please check if the accessories parts are completely received according to the letter labels and quantity below

BOX-E

Part		Qty	Part		Qty
A3		1PC	B3		1PC
3		8pcs	4		4pcs
6		2pcs			

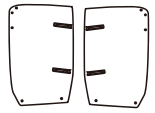
Step 1. Assemble Chair Arm Frames

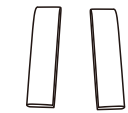
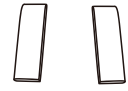
Let's start to assemble the Left Chair Arm Frame first, we named it N1 group
Please find and prepared those pieces with Labels: C1,D1,E1,F1,G1 and M

Label	Accessory Shape Reference	N1: Left Chair Arm N2:Right Chair Arm	
C1,C2		C1: Right side board of Left Arm	C2: Left Side Board of Right Arm
D1,D2		D1: Left side board of Left Arm	D2: Right Side Board of Right Arm
E1,E2		E1: Front Block of Left Arm	E2: Front Block of Right Arm
F1,F2		F1: Back Block of Left Arm	F2: Back Block of Right Arm
G1,G2		G1: Left cupholder frame	G2: Right cupholder frame
M		Screws Pack	

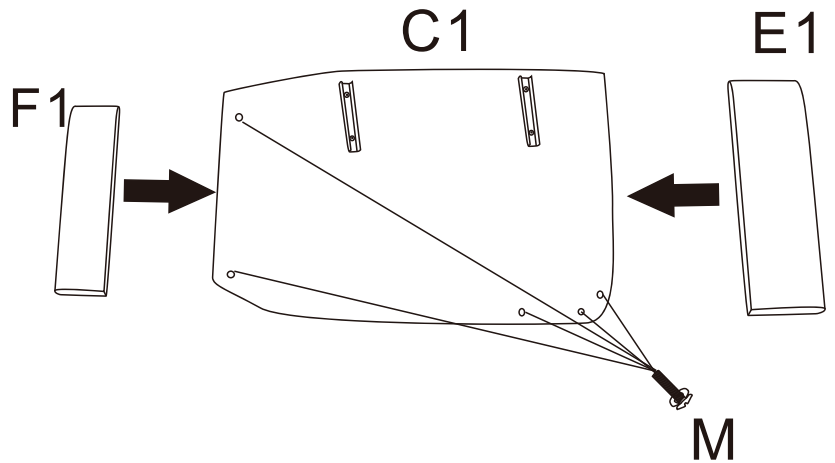

Fix E1 block and F1 block with screws to C1 board (side without the metal buckle)

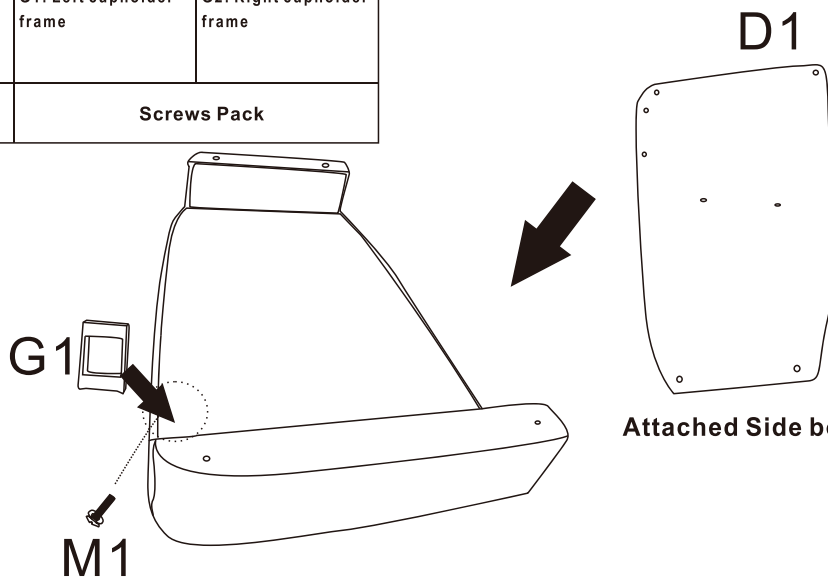

Attached Side board D1 to E1 and F1 with screws



Fix cupholder G1 with screws to the border position(as picture) by attaching to C1 and D1)

Please find and prepared those pieces with Labels: C2,D2,E2,F2,G2 and M to assemble the Right Chair Arm with the same way.We named the Right Arm as N2 group

Step 2. Finishe Chair Arms

Put the Left cover pillow (H1) to the Left chair arm frame(Assembled in step1);

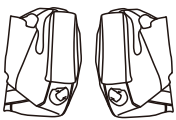
Note: the cupholder place should aim at the cupholder frame, make sure the cover is tension and smooth.

Label	Accessory Shape Reference	Name
H1 , H2		H1: Left Chair Am Cover Pillow H2: Right Chair Am Cover Pillow
M		Screws Pack

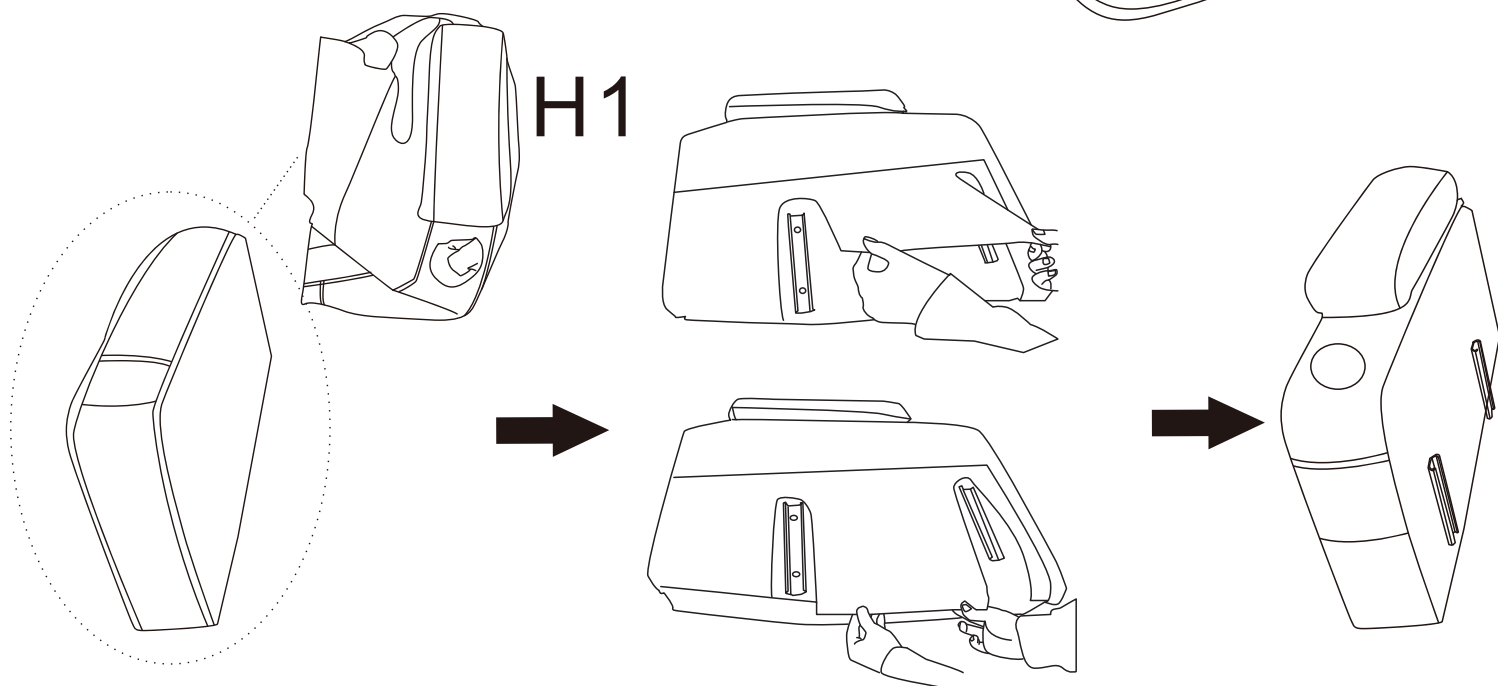
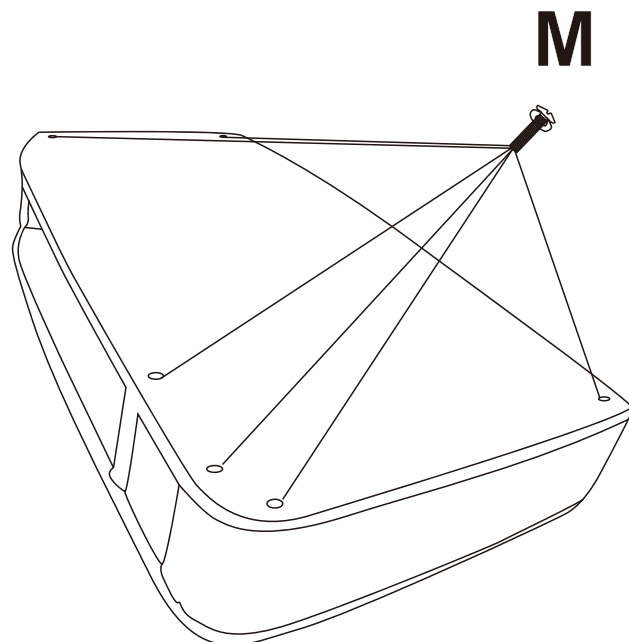

Then do the same as to right side(H2)

Step 3

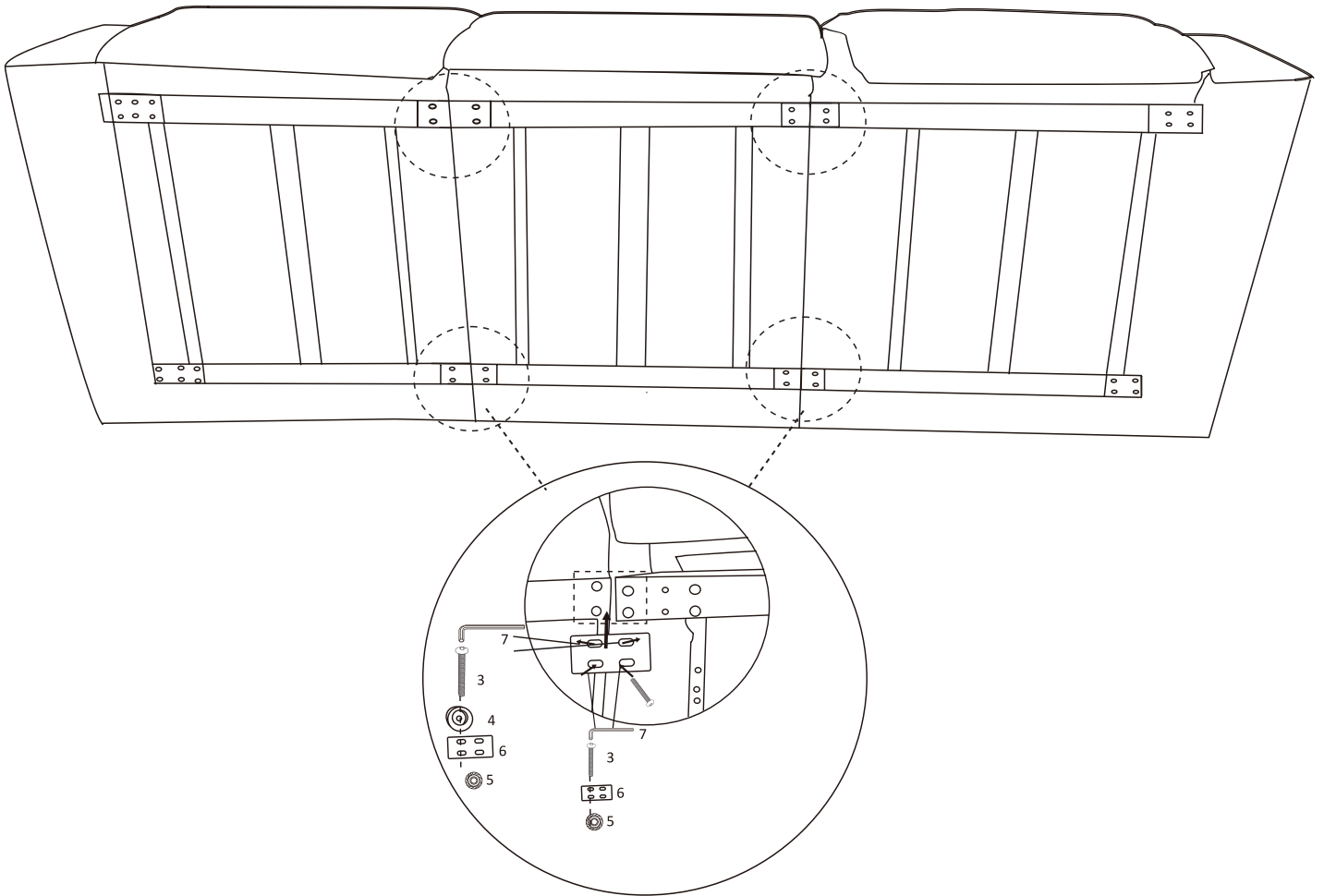

Accessories: Part 3*4 Part 4*4 Part 5*8 Part 6*2 Part 7*1

Operating Procedure:

Connect the Part A1/A2/A3 by using the Part 6. For the convenience to adjust parts connection, never fully tighten the screws until you finish the installation, tighten screws to 80%-90% is enough.

* Mounting two parts 4 horizontally side by side is more stable.

Step 4. Attached the Chair Arm

2 or More adults would be easier to assemble the chair.

① Put the seat pad (A) on the ground, attaching N1 (Left Arm) to seat pad, by inserting the 2 metal pegs of seat pad into the clips of the Left Arms.

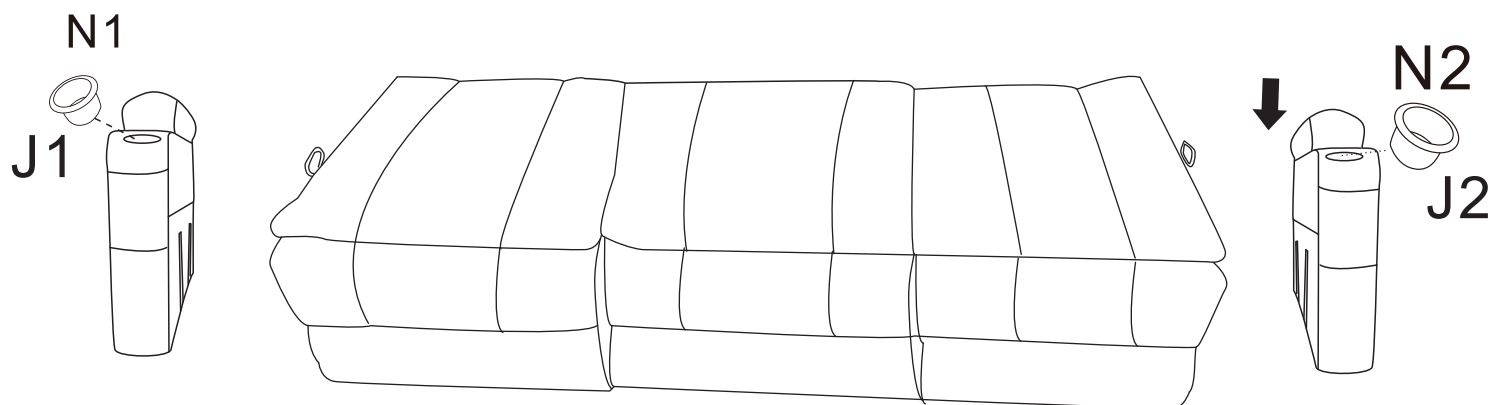

2 or More adults would be easier to assemble the chair.

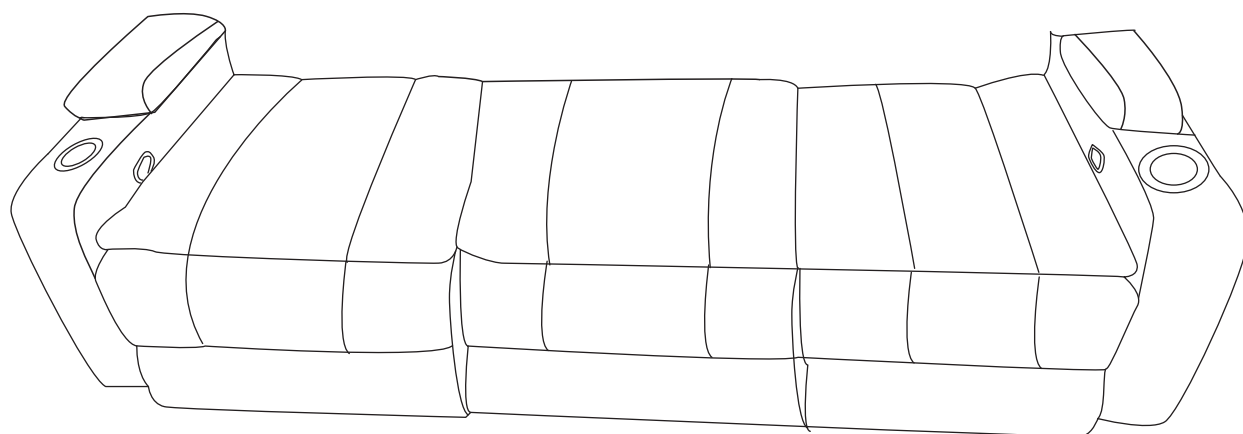

Please do the same to assemble the Right Arm.

Step 5. Assemble the backrest

- ① Attaching the Part B (Backrest) to the seat pad, by inserting the metal pegs of seat pad into the slots of the Backrest.
- ② Attach the 2 backrest wings (I1 and I2 as picture) to the backrest B with the same way.

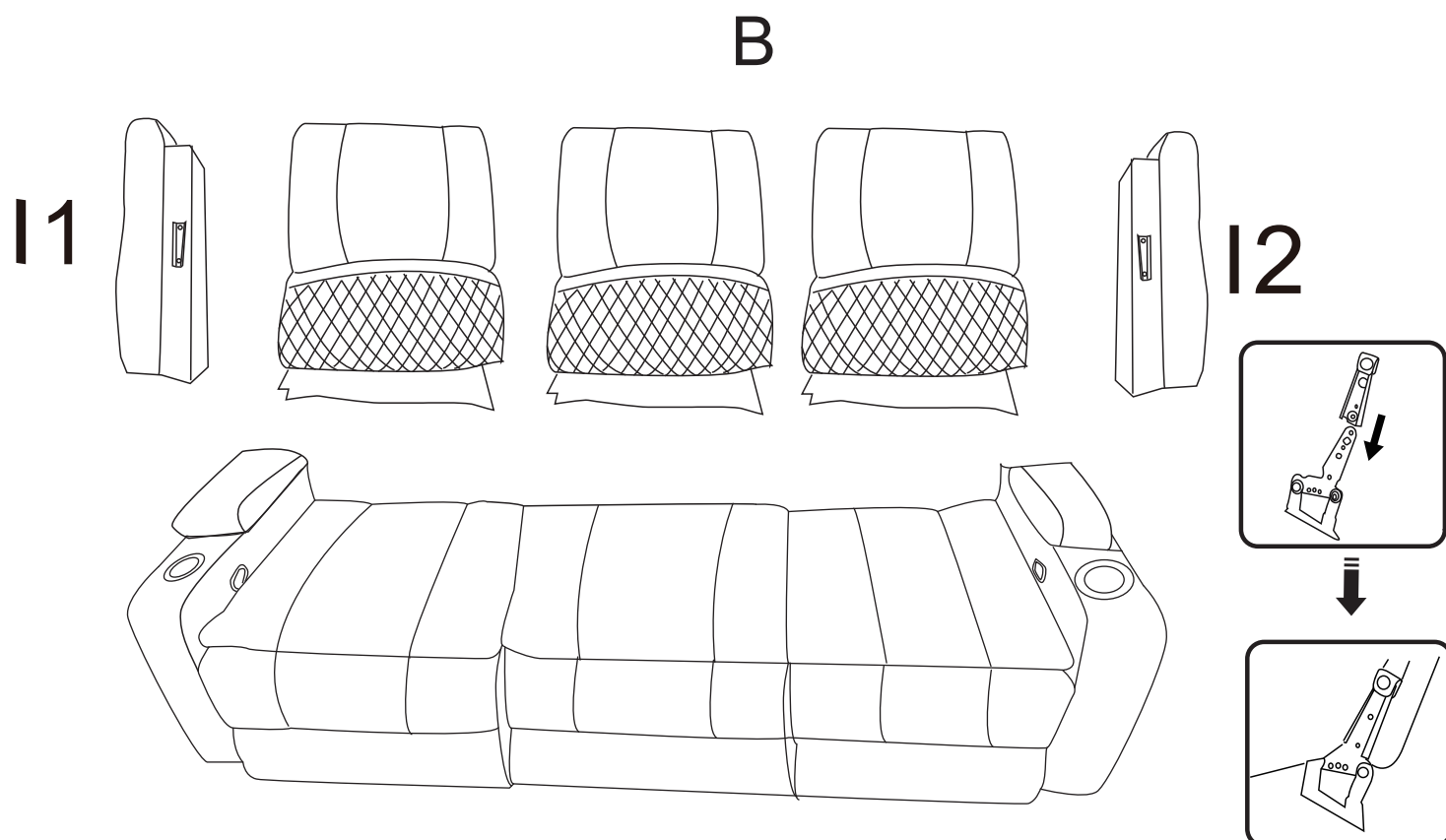

Accessories:

I1: Left backrest wings

I2: Right backrest wings

Step 6

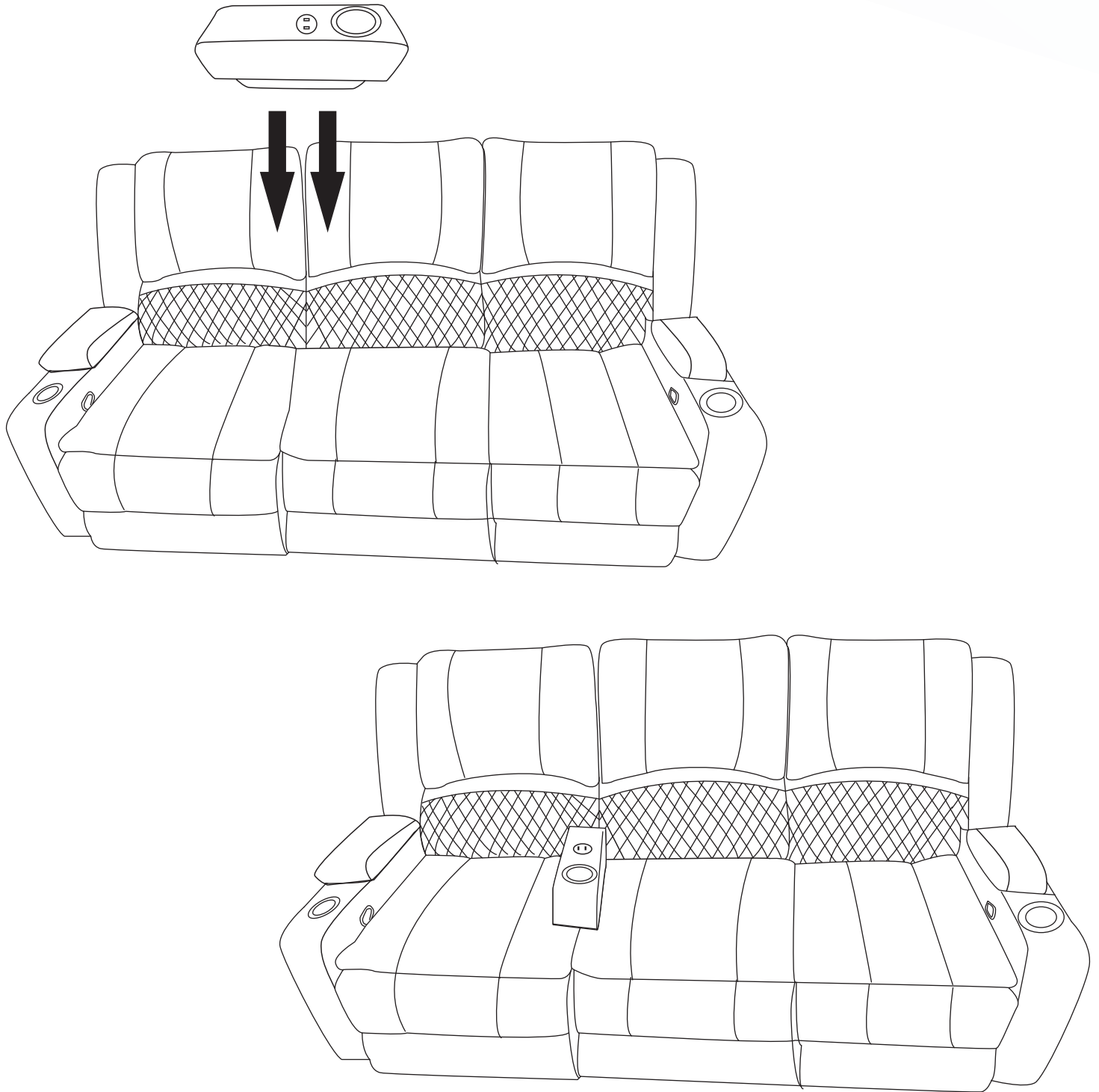

Step 7 . Enjoy the comfortable

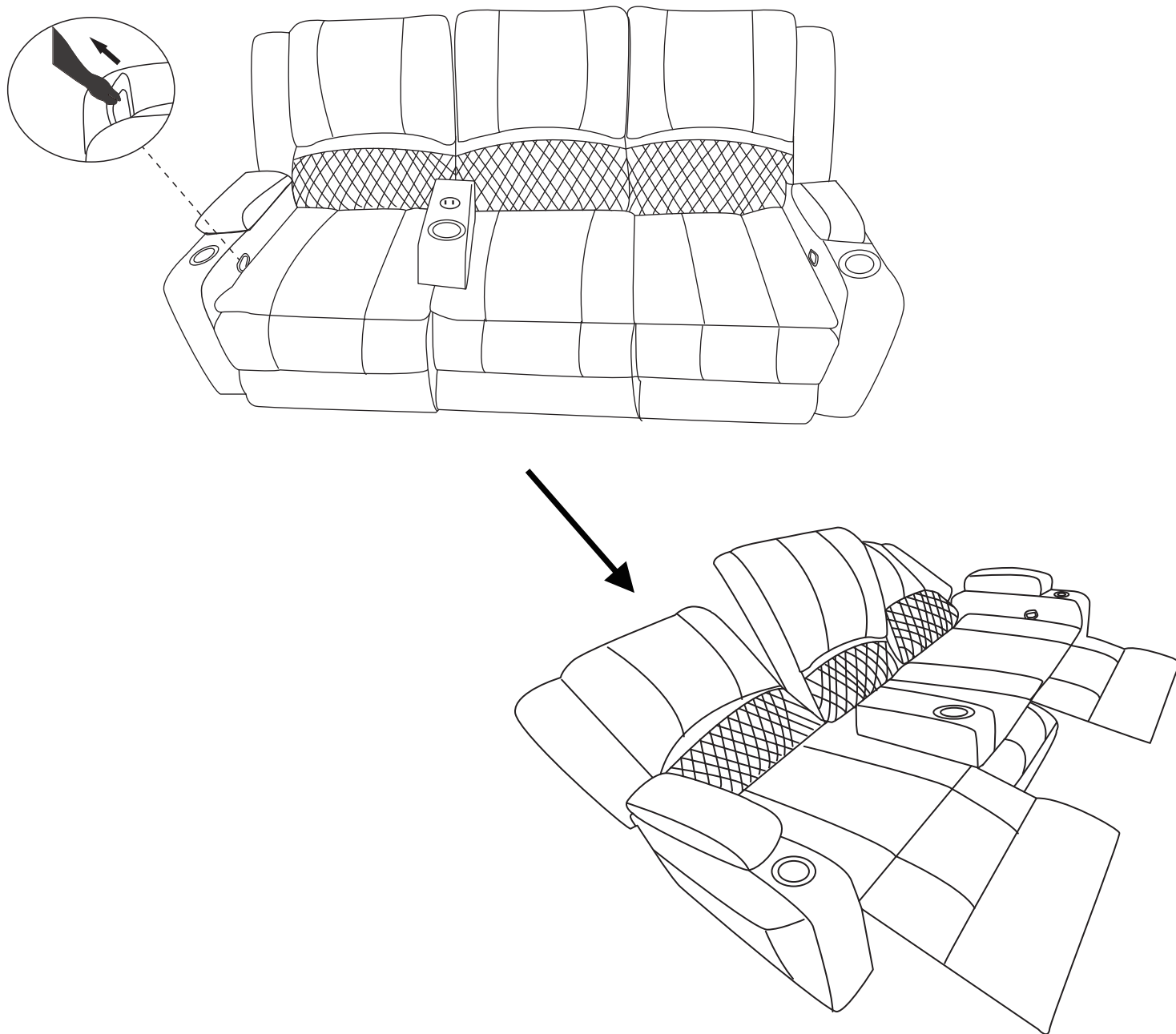

Sit down and pull the handle on right side, then the footrest raise up; move body backwards a little bit and with your own gravity to recline, enjoy the comfortable.

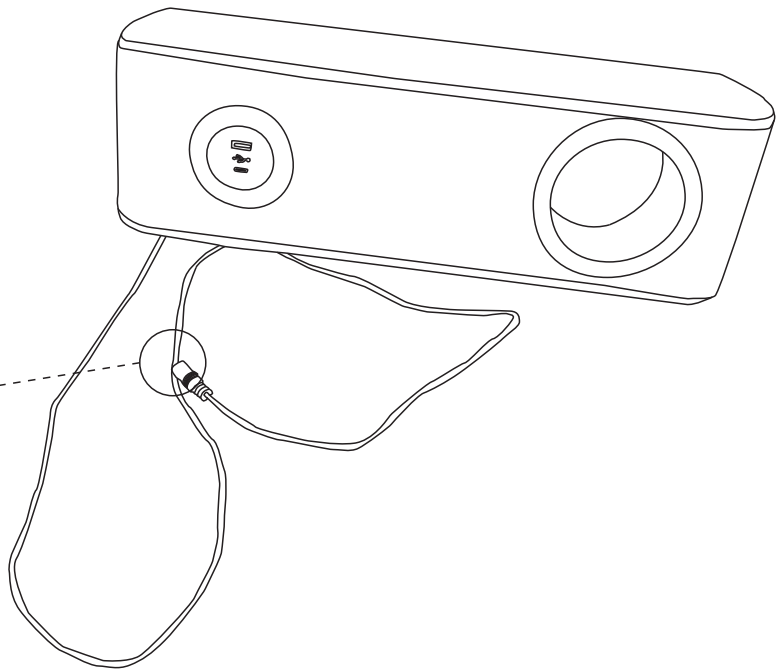
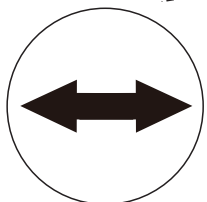
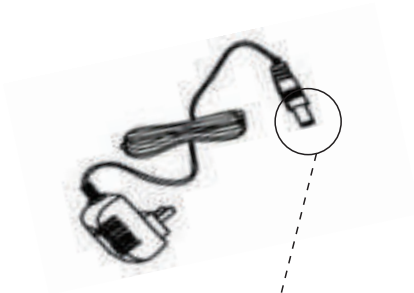
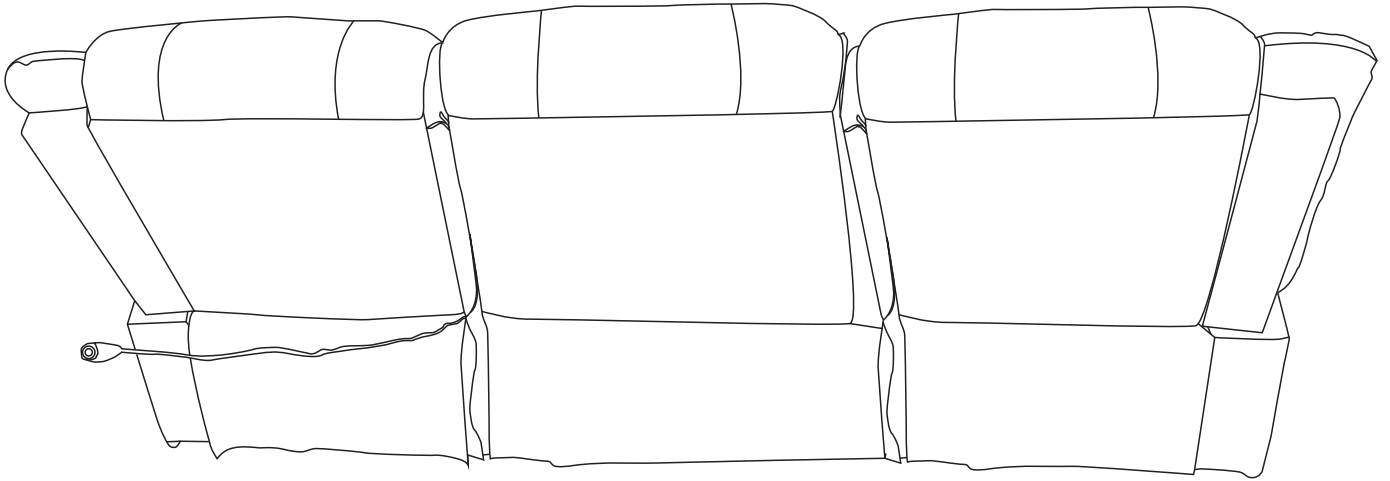

Warning

2-Person lift

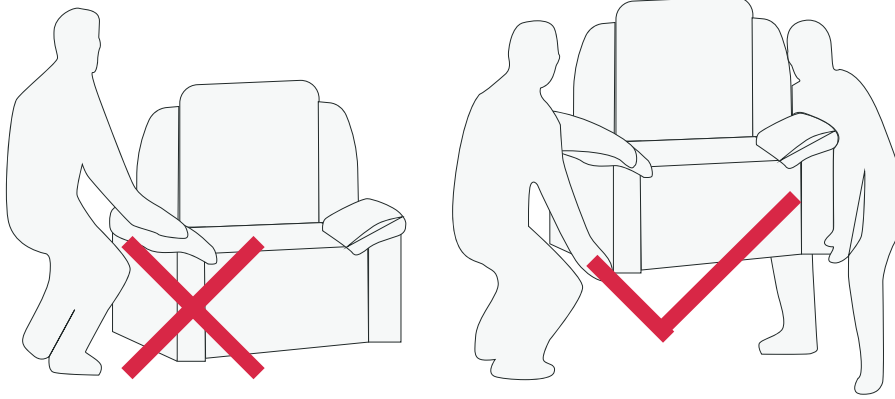

Do not move chair when it's reclining

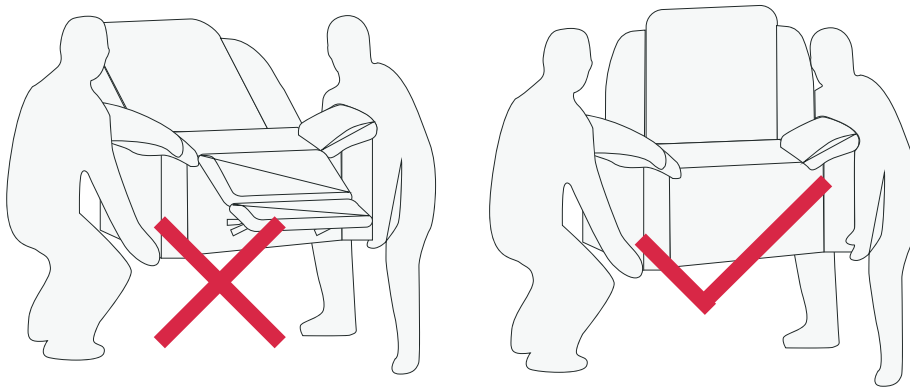

Leave enough space between chair back and wall before reclining

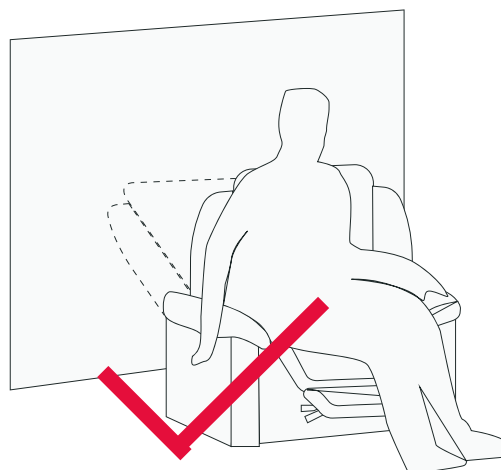
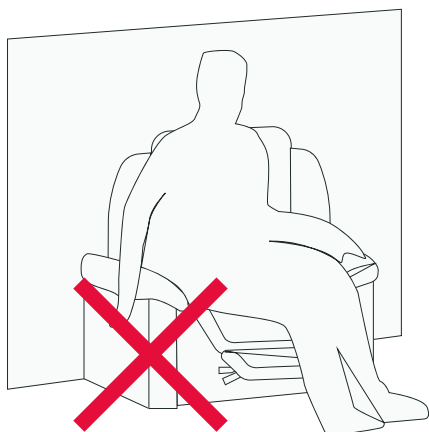

Do not sit on or press armrest



Do not press armrest after recline



Do not smoke or play with fire

Warning

Do not sit/kick/stand on the footrest when the chair is on reclining position

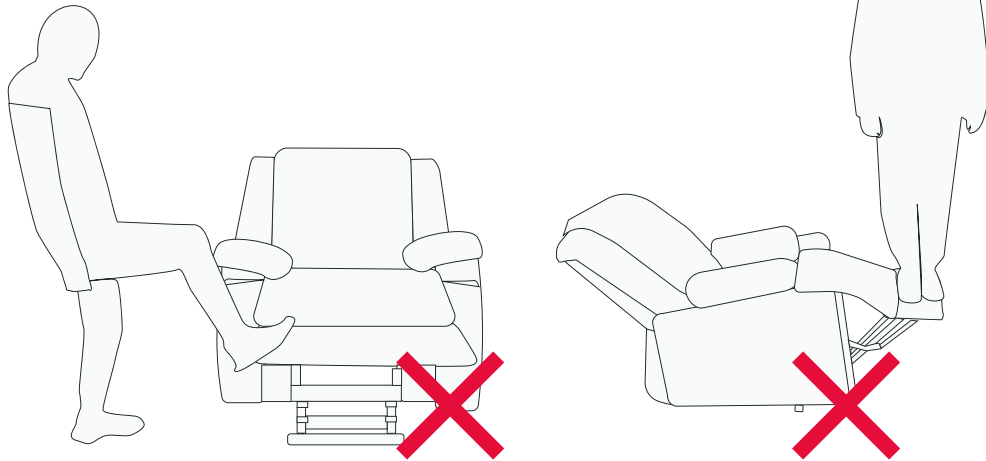

Do not stand up when the chair is on reclining position

