



SPA

MASSAGE BATHTUB

MODEL:EMPV-71JT618L



Introduction

In order to use our products safely and effectively, please read this instruction carefully. Improper installation, operation and maintenance will cause the damage to the products and charge you extra repairing fee.

—Thank you for you to choose our massage bathtub series;
—We provide a lifetime warranty after-sale service, please fill warranty registration form accurately;

—If you need any help, please contact local distributor or our company directly;

—Our company reserve the right to change all the models listed in this instruction without prior notice;

—This instruction applies to the listed products as below.

—Because of the difference of the market requirement and individual custom product, please refer to the corresponding content in this instruction according to the product and its functions you choose. In this way, you can install and operate the product correctly.

● In order to install the product correctly and safely by the installer, and you can use and maintain this product correctly and safely, please pay much attention to the warning sign as below

The warning symbol's meaning is as below:

	This symbol indicates that errant handling after disregarding this symbol could result in personal injury or property loss.
--	---

● In order to install, use and maintain this product correctly and safely, please read and understand this instruction totally.

● This instruction is a valuable source of product information to help the end user use the product safely and correctly. Please take good care of it and keep it from getting lost or soiled.

Preparation before installation

● Make sure the place you install the bathtub is strong enough to bear the total weight of bathtub, maximum water volume and the user.

● Waterproofing process must be made in the place of bathtub installed, or down stair will get damaged if water leaks.

- The installed place must equip with water supply, power supply and drainage:
- This product uses universal home power.

	Notice *External circuitry need to equip with high sensitive and fast type leakage protection switch. (Induced current rating below 15MA, trip time should less than 0.1 second, rated current is above 30A.) * The product should be installed the grounding and electric leakage switch by a qualified licensed electrician.
--	---

● Please reserve the drainage hole ≥ 50 mm, make sure the drainage pipes accord with the water valve.

● User need to reserve the connectors of 1/2" external thread cold/hot water hoses, which outstand the wall 30mm. It is suggested to install a valve in each pipe, the location of installed should be designed by user, which is convenient for maintaining.

● As each bathroom or power and drain of each bathtub is slightly different, please place the bathtub according to the actual situation, the following illustration as a reference layout:

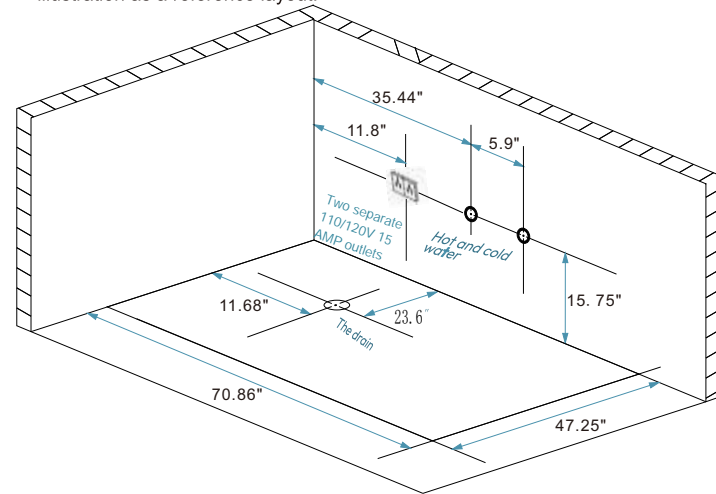

	Notice The safe distance between power supply and water supply should be not less than 30cm.
--	--

Precautions for installation

- Please check whether all parts are complete. If you have any question, please give feedback to our company in time.
- After opening the box, please immediately dispose of unneeded packaging. Or it may cause the personal injury by the wooden frames, nails, cardboard or sealing straps which are placed carelessly.
- In addition, please do not let the children to play with the packing material. Or it will cause personal injury.

- Parts containing live parts, except parts supplied with safety extra-low voltage not exceeding 12 V, must be inaccessible to a person in the bath
- Earthed appliances must be permanently connected to fixed wiring

- Parts incorporating electrical components, except remote control devices, must be located or fixed so that they cannot fall into the bath
- Please do not use other power, except specified power Or it may cause fire or electric shock.

- Electrical leakage protection switch should be installed outside the bathroom. Or it may cause fire or electric shock.
- Do not use the broken power supply, power plug or the loose socket. Or it may cause fire or electric shock.

- Do not modify the power supply cord, use it with an extension cord or combine it with other equipment using multiple plugs.

- Doing so could lead to shocks, overheating or fire.
- Please make sure the power plug is waterproof protection with silicon. Or it may cause fire or electric shock by water infiltration.

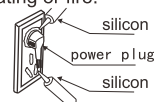

- Before the installation finish, please use cardboard to protect the bathtub or it may lead the damage of the bathtub.

- Do not put the fire on the bathtub, such as a lighted cigarette, or it may lead the damage of the bathtub.

- Do not stand on bathtub while working. Doing so could cause one to slip and fall or could otherwise damage the product.

- Install securely, in accordance with the Installation Manual. Improper installation can lead to water leaks that damage or ruin household property.

- After finish the installation, the product should go into trial operation fully to check the installation is proper or not.

	Notice
--	---------------

Size chart

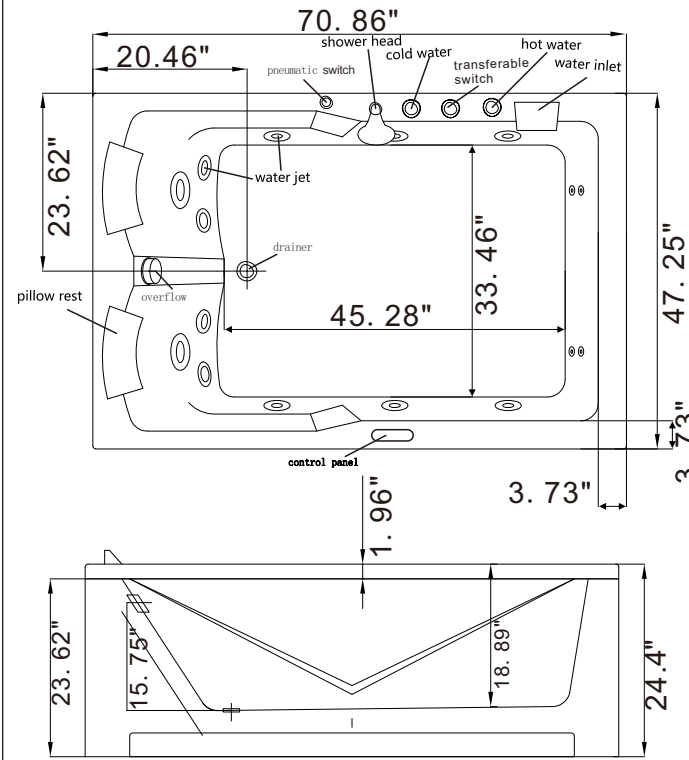

Installation instruction

● Inspection before installation

Although all our massage bathtub are water tested before they leave our factory, there may be some loose of the hose connections due to the transport. We need water test the product before installation. The steps are as follow:

- Place the tub on a flat surface in an area where it may be drained after testing. And adjust the feet to make the bathtub level;
- Check if there is any loose of all the connection system;
- Close the door, fill the tub with water to the overflow and allow standing for 10 minutes to inspect the tub for leaks;
- Insert the plug, start all the function for few minutes (which includes the functions of massage), inspect the tub completely any defect must be reported to your dealer/distributor prior to installation in order to have it covered under warranty.

● Adjust the leveling feet

According to different sizes bathtubs, we design about several leveling feet to adjust the bathtub. Please use a wrench or level ruler to level the bathtub.

Note: If the bathtub is not level, it may lead :

- noise increased;
- remaining water in the hoses or the drainage;
- bathtub shaking;

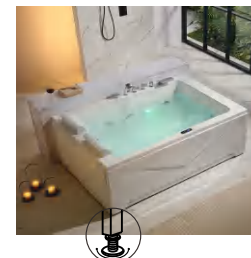
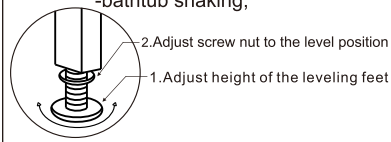

Installation instruction

● How to connect the water?

For ease of use, our bathtub is equipped with stainless steel cold and hot water hoses (connector \varnothing 1/2"). Please connect the cold and hot water hoses to the bathroom's cold and hot water hoses accordingly. Before connect bathtub water inlet pipe, first open water pipe for a period of time, then put filter screen to ensure that the debris will not enter the bathtub pipe. So that we can effectively extend the life of the fitting.

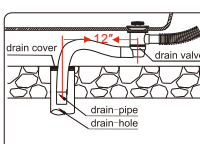
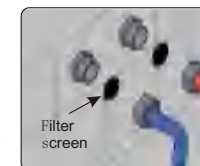

The drain pipe is 31.5" long and the ground drain should be 12" – 20" away from the bathtub drain so that the drainpipe can form an S-bend for odor isolation
Insert the drain-pipe to the drain-hole on the floor, and then cover it with water retaining cover to prevent waste water spilling.

	Notice The red hose is the hot water hose, and the blue hose is the cold water hose. The drain-pipe should be installed with a slope above 1:50. Notice: Do not hold the drain-pipe and cold/hot water hoses when moving the bathtub, and do not crash it with hard objects.
--	---

How to connect the electricity?

● How to connect the electricity?

User needs to purchase two separate 110/120V 15amp plugs and install the proper dedicated plug with a ground electrode to the power line. Then insert the plug rrmly.

Note: This product uses universal home power.

External circuitry is equipped with high sensitive and fast type leakage protection switch. (Induced current rating below 15MA; trip time should be less than 0.1 second; rated current is above 30A.)

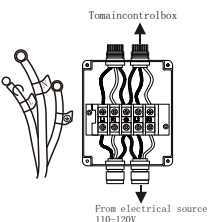

	Notice The product should be installed alongside ground and electric leakage switches by a licensed electrician.
--	--

Make sure the ground is connected. One side of the ground should be connected to the ground terminal of the motor and the stainless steel frame; the other side should be connected to the ground wires of the plug.

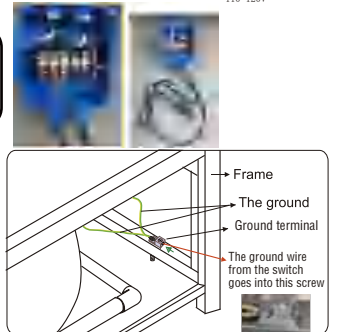

	Notice The bathtub must be connected to the ground. The power outlet must be sealed well. Make sure the surface of each wire is intact
--	--

Precautions for use

	Notice Please refer to the model and configuration you have chosen when using the product. • Use this unit only for its intended use as described in this manual. Do not use attachments not recommended by the manufacturer. Do not tamper with user-operated controls or any similar devices. • Do not immerse the control panel by overflowing the bath.
	Notice become nauseous, dizzy, or develop a headache, get out at once and cool down. Get medical attention if symptoms persist. Check with a physician before using whirlpool again. • Persons using medication should consult a physician before using a whirlpool. Medication may induce drowsiness or affect heart rate, blood pressure, and circulation. • Do not operate this unit without the suction cover over the suction fitting. Keep body and hair a minimum of 6" (152 mm) away from the suction fitting at all times when the pump is running. • Do not use a hydro massage bathtub equipped with a heater immediately following strenuous exercise. • Never drop or insert any object in any opening within the whirlpool. Never operate electrically connected devices in or near the bath. No electric appliances (i.e., hair dryer, lamp, telephone, radio, television, etc.) should be within 5 feet (1.5 meters) of this bathtub.

This bathtub is designed for "fill and drain" use, which means the bathtub needs to be drained after each use and refilled with fresh water for the next bather. This is a health precaution, as these bathtubs are not designed to hold water continuously, like pools or spas.
Close the drain and fill the bathtub until water is at least 1" to 2" (25 mm to 51 mm) above the highest jet or air inlet (as indicated by water line in the right diagram). Do not turn on the Whirlpool or Air system at any time if the jets or air inlets are not fully immersed in water. Doing so may cause water to spray outside the bathtub area.

1" –2" above the top jet



	Notice When exiting the bathtub, the water level will drop below the jets, resulting in water to spray out of the unit. To prevent this, you must turn the unit OFF before exiting the bathtub.
--	---

● **SNY-371 Control panel operation:**

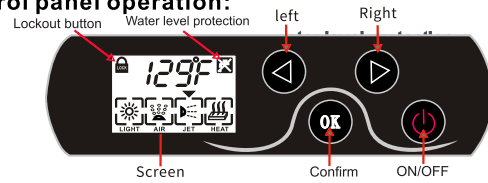

Operation :

1. ON/OFF : insert the plug ,press to switch on the power .The screen will show the temperature of water and the lamp will light up.You can perform setting and operation of various function according to the requirement of users .The system can be directly switch off by pressing .

2. Surfing function :

Press "" or "" to select the lamp icon ,as shown to the right:

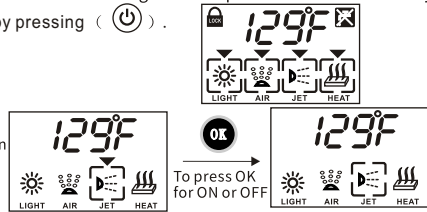

Notice : The water pump is limited by water level ,it only be launched under the condition of water level .If short of water ,the will flicker ,water um can not start .The um will be turned off automaticall ever 60 minutes .

3. Heating function :

Press "" or "" to select the heating icon , as shown to the right

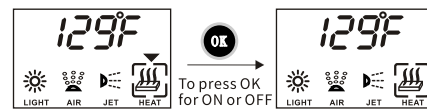

Notice : only under the surfing function on ,the heating function can be launched ,and control by the preset temperature . Default 40°C . When the water temperature reach to the preset temperature ,it will turn into constant temperature .

4. Lamp : when power on ,it will light up ,and when power off ,it will light off.

Press "" or "" to select the lamp icon ,as shown to the right:

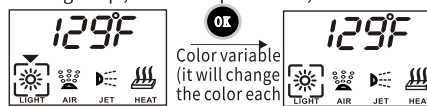

Notice: It will light up when the power on ,only power off can light off the lamp .The above only can change the color .

(red → blue → green → seven color allochromis → white)

it will change the color each time you press OK

5. Lockout button : After 2 minutes of inactivity on the screen, the panel will be locked, and a lock icon will appear in the upper left corner. To unlock, gently touch the OK key with your fingertip.

	The light will illuminate and change colors automatically when the control panel is turned on. Press OK to change different light colors.
	In the event of a water shortage(below the the minimum water level), it will be indicated by a flashing icon and water pump will be unable to operate . The pump will turn off automatically every 60 minutes.
	The air bubbles will turn off automatically every 60 minutes.

	The heater is equipped with a preset vacuum switch that prevents it from activating if the pump is not running and water is not flowing through the whirlpool system. As a result, only when water jets are on, the heating function can be activated, and the temperature can be adjusted accordingly. The heater will only function when the water temp is 77°F or higher. It is recommended to fill the bathtub with warm water to ensure that the heater can function as intended. When the water temperature reaches 104°F (40°C), the inline heater will automatically shut off.
	Automatic keyboard locking : If no action on the keyboard for 2 minutes, icon will appear on the screen, indicating that the keyboard is locked automatically. Please press OK to unlock the keyboard.

● **Waist drum shape three-piece set faucet:**

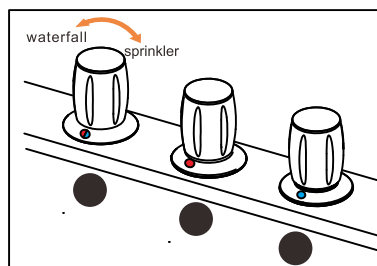

- A. cold water switch (Marked with letter C)
- B. hot water switch (Marked with letter H)
- C. waterfall/sprinkling style transferable switch (Marked with Icon)

● **Multi-function handheld shower with back flow protector.**

Rotate the shower head shell can adjust

the water pattern as follow:

- inner water column
- middle water column
- external water column



SHOWER INSTALLATION

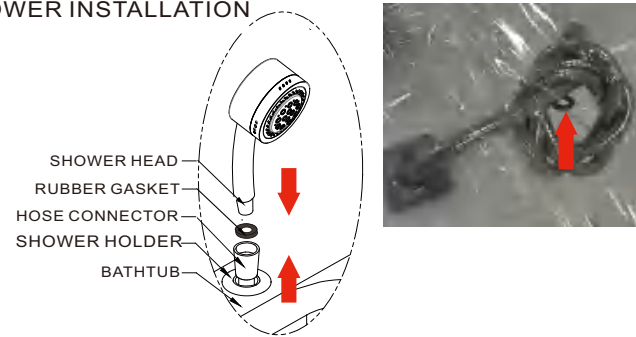

SHOWER HEAD INSTALLATION

Tmaking sure it lies flat.o install the shower head, follow the steps shown in Figure A.

First, remove the hose connector from the shower holder.

Then, insert the rubber gasket into the hose connector,

Finally, tighten the shower head and the hose connector securely.

● **Water jets use:**

- To change the direction of the water flow, swivel the jet nozzle to the desired angle
- Increase the force of the flow by rotating the nozzle or jet face to the left (counterclockwise). Decrease the force of the flow by rotating the nozzle or jet face to the right (clockwise).

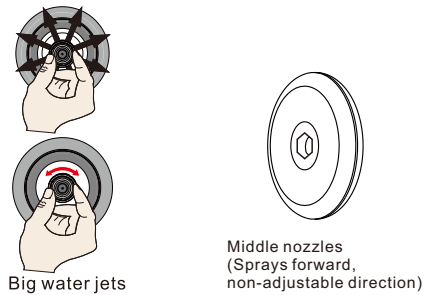

● **Hydro massage flow rate control switch**



Rotate hydro massage flow rate control switch clockwise, then the water column strength smaller; rotate the knob anticlockwise, then the water column strength stronger. (Only for the model with hydro massage flow rate control switch)

● **Drainage**

1. Manual drainage

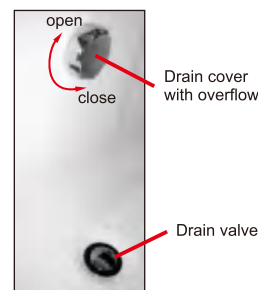

Rotate the cover clockwise to close the drain; Rotate the cover anticlockwise to open the drain; When the water is over the maximum water level, the excess water will be drained by overflow.

Care and Maintenance

Regular bathtub maintenance will keep it clean and working at its best. Pump and pipe circulation systems should be flushed before frst use and on a monthly basis when product is under normal use. Below is the recommended cleaning procedure:

1. Do not run the jet massage system dry.
2. Fill the tub with hot water about(40°C) 2-3 cm (0.9-1.2 inch) above the jets. Add 2-3 teaspoons of low foaming detergent, such as dishwashing machine detergent.
3. Turn on all the functions and run for 10 minutes.

4. Drain tub completely.
5. Fill tub with cold water above jets.
6. Turn on all the functions and run for 15 minutes.
7. Drain tub completely.
8. Clean the "suction cover" by removing any hair or lint.

Whirlpool Suction Cover/Strainer

Maintain regular cleaning of the suction cover/strainer

1. Rotate the suction cover to the left to detach it.
2. Remove any hair, lint, or debris present on the cover and housing.
3. Remember to reattach the cover in place.

WARNING! Please orient the cover/strainer with the small notch at the bottom. The gasket must be inserted into the groove of the cover/strainer before mounting it onto the suction fitting.

DANGER: RISK OF SEVERE INJURY OR DROWNING!

- a. Keep hair a minimum of 6 inches (152 mm) away from the suction fitting at all times when the whirlpool system is operating. Individuals with shoulder-length hair should secure it close to their heads or wear a bathing cap.
- b. Do not operate the Whirlpool system with the suction cover/strainer removed! It is a safety device and must always be in place on the suction fitting to minimize the potential hazard of hair and body entrapment.

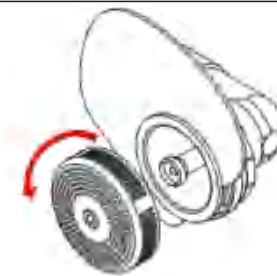

	Always implement countermeasures that help prevent freezing. You must empty the bathtub and the water in the pipe during winter use. If the pipes freeze, the pipes could rupture or equipment could become damaged.
	Use no water other than standard tap water. The use of well water could cause corrosion, which could lead to leaks.
	The bathtub should not be exposed to ultraviolet or bright light, otherwise aging could be accelerated, causing damage.
	Keep the bathtub away from cigarette butts, hair dryers, and other heat sources, otherwise the product may be damaged due to high temperature deformation.
	When not in use, please keep the bathtub well-ventilated and dry; avoid contact with corrosive substances; cut off electricity and cut off water supply.
	To avoid other damage, please do not drop or strike the bathtub with hard objects. Doing so could crack or scratch the bathtub or cause leaks that damage or ruin household property.
	When the product is at work, you cannot cut off any connection lines and split the bus master and control panel. Any part of the control panel and the bus master CAN NOT be split by the user. Doing so may cause product leakage, electric shock, or other accidents.
	The ground fault circuit interrupter (GFCI) should be tested regularly. It is ideal to test before each use.
	Use water or mild detergent to clean the product. Do not use acids, alkalis, chemical organic solvents, or acidic/alkaline cleaning agents. Otherwise, the bathtub will experience surface damage. When water or a neutral detergent cannot remove stains, use a clean cloth with a little alcohol to remove stains.
	Plating parts maintenance: use cotton fabric to scrub.
	Light scratches and dulled areas may be restored to original luster by coarse grinding using NO. 1200 waterproof sandpaper dipped in water. Then fine grind by using NO. 2000 waterproof sandpaper dipped in water. Finally, polish with a soft cloth and a polishing agent.
	When not in use, please keep the bathtub well-ventilated and dry; avoid contact with corrosive substances; cut off electricity and cut off water supply.

Troubleshooting Guide

PROBLEMS	CAUSES	SOLUTIONS
Pump/motor and jets do not operate	1. No power to pump/motor 2. Water level does not reach high enough 3. Defective Pump/motor	1. Check for the power connections and the fuse in blue terminal box; Make sure control panel and pumps are connected to control box properly. 2. Inflow water until it reaches the minimum water level of the bathtub 3. Contact Empava for WARRANTY & SERVICE
Not all jets are functioning	• Jets are closed	1. Adjust the jets by rotating clockwise/anticlockwise 2. Contact Empava for WARRANTY & SERVICE
Water leakage from pump/motor	1. O ring is pinched or faulty 2. Screw nut is not tightened or connected properly	1. Replace the old ring 2. Tighten the screw nut and make sure it's in good connection 3. Contact Empava for WARRANTY & SERVICE

Water leakage from PVC pipes	The glass glue is not enough	1. Apply glass glue to seal it 2. Contact Empava for WARRANTY & SERVICE
Water leakage from drainage	1. O ring is pinched or faulty 2. Drain pipe is broken	1. Replace the old ring or the drainer 2. Replace the drain pipe 3. Contact Empava for WARRANTY & SERVICE
Water leakage from hardware	1. O ring is pinched or faulty 2. Defective control valve	1. Replace the old ring or faucet/showerhead 2. Replace the control valve under knobs 3. Contact Empava for WARRANTY & SERVICE
LED lights do not operate	• Loose connection	• Contact Empava for WARRANTY & SERVICE
Waterfall is not functioning	1. Massage is not selected 2. Waterfall control knob turns to OFF position 3. Debris stuck in the waterfall outlet	1. Turn on the massage function 2. Turn waterfall knob anticlockwise to the desired water flow 3. Clean out debris

Empava® APPLIANCES WARRANTY	
WHAT IS COVERED	WHAT IS NOT COVERED

TWO YEARS WARRANTY (PARTS)

Empava offers a two-year warranty on parts for the following categories: induction cooktop, gas cooktop, electrical oven, pizza oven, fre glass, juicer, range hood, wine cooler, beverage refrigerator and toilet seat

TWO YEARS WARRANTY (PARTS & LABOR)

Empava offers a two-year warranty on both parts and labor for the following categories: gas oven and gas range.

THREE YEARS WARRANTY (PARTS & LABOR)

Empava provides a three-year warranty on both parts and labor for the following categories: freestanding tub, massage tub, and walk-in tub.

This limited warranty is valid for products that are either purchased brand new from an authorized Empava dealer or directly from Empava.

The effective date of the warranty commences from the date of original consumer purchase. If the appliance is installed, operated, and maintained in accordance with the user manual, Empava will provide parts at no cost to rectify any defects in materials and workmanship that were present at the time of purchase. Alternatively, at its sole discretion, Empava may replace the product. In the event of product replacement, the warranty for the replacement product shall be valid for the remaining term of the original warranty period.

DISCLAIMER OF IMPLIED WARRANTIES

IMPLIED WARRANTIES, INCLUDING ANY IMPLIED WARRANTY OF MERCHANTABILITY OR IMPLIED WARRANTY OF FITNESS FOR A PARTICULAR PURPOSE, ARE LIMITED TO ONE YEAR OR THE SHORTEST PERIOD ALLOWED BY LAW. Some states and provinces do not allow limitations on the duration of implied warranties of merchantability or fitness, so this limitation may not apply to you. This warranty gives you specific legal rights, and you also may have other rights that vary from state to state or province to province.

DISCLAIMER OF REPRESENTATIONS OUTSIDE OF WARRANTY

If you want a longer or more comprehensive warranty than the limited warranty that comes with this major appliance, you should ask Empava or your retailer about buying an extended warranty.

LIMITATION OF REMEDIES: EXCLUSION OF INCIDENTAL AND CONSEQUENTIAL DAMAGES -

HEREIN, EMPAVA SHALL NOT BE LIABLE FOR INCIDENTAL OR CONSEQUENTIAL DAMAGES. Some states and provinces do not allow the exclusion or limitation of incidental or consequential damages, so these limitations and exclusions may not apply to you. This warranty gives you specific legal rights, and you also may have other rights that vary from state to state or province to province.

WARNING!
CALIFORNIA RESIDENTS
Cancer and Reproductive Harm

AVERTISSEMENT!
RÉSIDENTS DE CALIFORNIE
Cancer et Dommages à la Reproduction

¡ADVERTENCIA!
RESIDENTES DE CALIFORNIA
Cáncer y Daño Reproductivo

www.P65W amngs.ca.gov

EMPAVA APPLIANCES INC.
458 Parriott Place West, City of Industry, California
91745, United States
TEL: 888-682-8882
WWW.EMPAVA.COM

● **SNY-371 Control panel operation:**

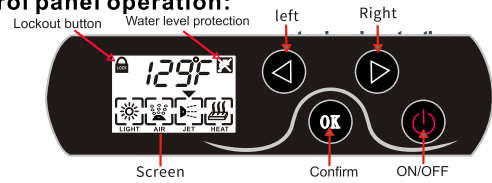

Operation :

1. ON/OFF : insert the plug ,press to switch on the power .The screen will show the temperature of water and the lamp will light up.You can perform setting and operation of various function according to the requirement of users .The system can be directly switch off by pressing .

2. Surfing function :

Press “” or “” to select the lamp icon ,as shown to the right:

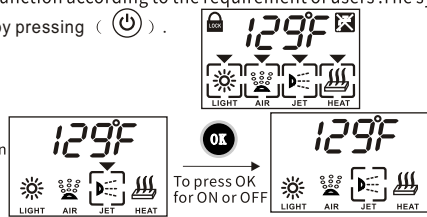

Notice : The water pump is limited by water level ,it only be launched under the condition of water level .If short of water ,the will flicker ,water pump can not start .The pump will be turned off automatically every 60 minutes .

3. Heating function :

Press “” or “” to select the heating icon , as shown to the right:

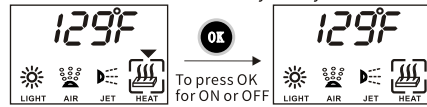

Notice : only under the surfing function on ,the heating function can be launched ,and control by the preset temperature . Default 40℃ , When the water temperature reach to the preset temperature ,it will turn into constant temperature .

4. Lamp : when power on ,it will light up ,and when power off ,it will light off.

Press “” or “” to select the lamp icon ,as shown to the right:



Notice: It will light up when the power on ,only power off can light off the lamp .The above only can change the color .

(red → blue → green → seven color allochromism → white)

it will change the color each time you press OK

5. Lockout button : After 2 minutes of inactivity on the screen, the panel will be locked, and a lock icon will appear in the upper left corner. To unlock, gently touch the OK key with your fingertip.

	The light will illuminate and change colors automatically when the control panel is turned on. Press OK to change different light colors.
	In the event of a water shortage(below the the minimum water level), it will be indicated by a flashing icon and water pump will be unable to operate . The pump will turn off automatically every 60 minutes.
	The air bubbles will turn off automatically every 60 minutes.

	The heater is equipped with a preset vacuum switch that prevents it from activating if the pump is not running and water is not flowing through the whirlpool system. As a result, only when water jets are on, the heating function can be activated, and the temperature can be adjusted accordingly. The heater will only function when the water temp is 77°F or higher. It is recommended to fill the bathtub with warm water to ensure that the heater can function as intended. When the water temperature reaches 104°F (40°C), the inline heater will automatically shut off.
	Automatic keyboard locking : If no action on the keyboard for 2 minutes, icon will appear on the screen, indicating that the keyboard is locked automatically. Please press OK to unlock the keyboard.

● **Waist drum shape three-piece set faucet:**

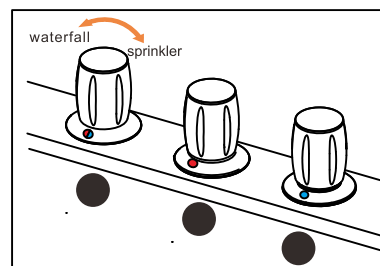

- A. cold water switch (Marked with letter C)
- B. hot water switch (Marked with letter H)
- C. waterfall/sprinkling style transferable switch (Marked with Icon)

● **Multi-function handheld shower with back flow protector.**

Rotate the shower head shell can adjust the water pattern as follow:

- inner water column
- middle water column
- external water column



SHOWER INSTALLATION

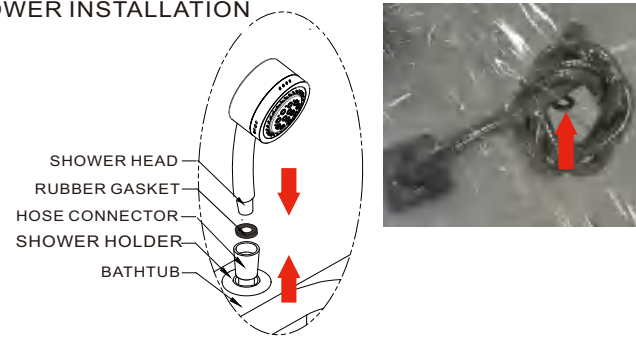

SHOWER HEAD INSTALLATION

Make sure it lies flat. To install the shower head, follow the steps shown in Figure A.

First, remove the hose connector from the shower holder. Then, insert the rubber gasket into the hose connector, Finally, tighten the shower head and the hose connector securely.

● **Water jets use:**

- To change the direction of the water flow, swivel the jet nozzle to the desired angle
- Increase the force of the flow by rotating the nozzle or jet face to the left (counterclockwise). Decrease the force of the flow by rotating the nozzle or jet face to the right (clockwise).

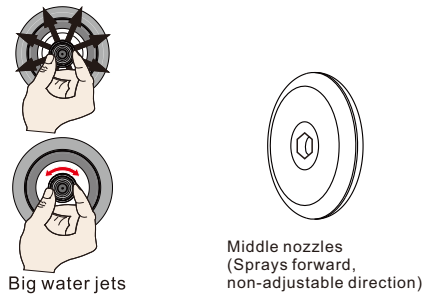

● **Hydro massage flow rate control switch**



Rotate hydro massage flow rate control switch clockwise, then the water column strength smaller; rotate the knob anticlockwise, then the water column strength stronger. (Only for the model with hydro massage flow rate control switch)

● **Drainage**

1. Manual drainage

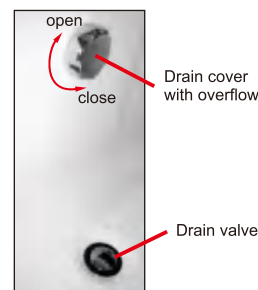

Rotate the cover clockwise to close the drain; Rotate the cover anticlockwise to open the drain; When the water is over the maximum water level, the excess water will be drained by overflow.

Care and Maintenance

Regular bathtub maintenance will keep it clean and working at its best. Pump and pipe circulation systems should be flushed before first use and on a monthly basis when product is under normal use. Below is the recommended cleaning procedure:

1. Do not run the jet massage system dry.
2. Fill the tub with hot water about (40°C) 2-3 cm (0.9-1.2 inch) above the jets. Add 2-3 teaspoons of low foaming detergent, such as dishwashing machine detergent.
3. Turn on all the functions and run for 10 minutes.

4. Drain tub completely.
5. Fill tub with cold water above jets.
6. Turn on all the functions and run for 15 minutes.
7. Drain tub completely.
8. Clean the “suction cover” by removing any hair or lint.

Whirlpool Suction Cover/Strainer

Maintain regular cleaning of the suction cover/strainer

1. Rotate the suction cover to the left to detach it.
2. Remove any hair, lint, or debris present on the cover and housing.
3. Remember to reattach the cover in place.

WARNING! Please orient the cover/strainer with the small notch at the bottom. The gasket must be inserted into the groove of the cover/strainer before mounting it onto the suction fitting.

DANGER: RISK OF SEVERE INJURY OR DROWNING!

- a. Keep hair a minimum of 6 inches (152 mm) away from the suction fitting at all times when the whirlpool system is operating. Individuals with shoulder-length hair should secure it close to their heads or wear a bathing cap.
- b. Do not operate the Whirlpool system with the suction cover/strainer removed! It is a safety device and must always be in place on the suction fitting to minimize the potential hazard of hair and body entrapment.

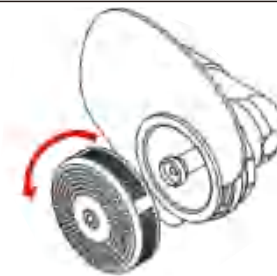

	Always implement countermeasures that help prevent freezing. You must empty the bathtub and the water in the pipe during winter use. If the pipes freeze, the pipes could rupture or equipment could become damaged.
	Use no water other than standard tap water. The use of well water could cause corrosion, which could lead to leaks.
	The bathtub should not be exposed to ultraviolet or bright light, otherwise aging could be accelerated, causing damage.
	Keep the bathtub away from cigarette butts, hair dryers, and other heat sources, otherwise the product may be damaged due to high temperature deformation.
	When not in use, please keep the bathtub well-ventilated and dry; avoid contact with corrosive substances; cut off electricity and cut off water supply.
	To avoid other damage, please do not drop or strike the bathtub with hard objects. Doing so could crack or scratch the bathtub or cause leaks that damage or ruin household property.
	When the product is at work, you cannot cut off any connection lines and split the bus master and control panel. Any part of the control panel and the bus master CAN NOT be split by the user. Doing so may cause product leakage, electric shock, or other accidents.
	The ground fault circuit interrupter (GFCI) should be tested regularly. It is ideal to test before each use.
	Use water or mild detergent to clean the product. Do not use acids, alkalis, chemical organic solvents, or acidic/alkaline cleaning agents. Otherwise, the bathtub will experience surface damage. When water or a neutral detergent cannot remove stains, use a clean cloth with a little alcohol to remove stains.
	Plating parts maintenance: use cotton fabric to scrub.
	Light scratches and dulled areas may be restored to original luster by coarse grinding using NO. 1200 waterproof sandpaper dipped in water. Then fine grind by using NO. 2000 waterproof sandpaper dipped in water. Finally, polish with a soft cloth and a polishing agent.
	When not in use, please keep the bathtub well-ventilated and dry; avoid contact with corrosive substances; cut off electricity and cut off water supply.

Troubleshooting Guide

PROBLEMS	CAUSES	SOLUTIONS
Pump/motor and jets do not operate	1. No power to pump/motor 2. Water level does not reach high enough 3. Defective Pump/motor	1. Check for the power connections and the fuse in blue terminal box; Make sure control panel and pumps are connected to control box properly. 2. Inflow water until it reaches the minimum water level of the bathtub 3. Contact Empava for WARRANTY & SERVICE
Not all jets are functioning	• Jets are closed	1. Adjust the jets by rotating clockwise/anticlockwise 2. Contact Empava for WARRANTY & SERVICE
Water leakage from pump/motor	1. O ring is pinched or faulty 2. Screw nut is not tightened or connected properly	1. Replace the old ring 2. Tighten the screw nut and make sure it's in good connection 3. Contact Empava for WARRANTY & SERVICE

Water leakage from PVC pipes	The glass glue is not enough	1. Apply glass glue to seal it 2. Contact Empava for WARRANTY & SERVICE
Water leakage from drainage	1. O ring is pinched or faulty 2. Drain pipe is broken	1. Replace the old ring or the drainer 2. Replace the drain pipe 3. Contact Empava for WARRANTY & SERVICE
Water leakage from hardware	1. O ring is pinched or faulty 2. Defective control valve	1. Replace the old ring or faucet/showerhead 2. Replace the control valve under knobs 3. Contact Empava for WARRANTY & SERVICE
LED lights do not operate	• Loose connection	• Contact Empava for WARRANTY & SERVICE
Waterfall is not functioning	1. Massage is not selected 2. Waterfall control knob turns to OFF position 3. Debris stuck in the waterfall outlet	1. Turn on the massage function 2. Turn waterfall knob anticlockwise to the desired water flow 3. Clean out debris

Empava® APPLIANCES WARRANTY	
WHAT IS COVERED	WHAT IS NOT COVERED

TWO YEARS WARRANTY (PARTS)

Empava offers a two-year warranty on parts for the following categories: induction cooktop, gas cooktop, electrical oven, pizza oven, fre glass, juicer, range hood, wine cooler, beverage refrigerator and toilet seat

TWO YEARS WARRANTY (PARTS & LABOR)

Empava offers a two-year warranty on both parts and labor for the following categories: gas oven and gas range.

THREE YEARS WARRANTY (PARTS & LABOR)

Empava provides a three-year warranty on both parts and labor for the following categories: freestanding tub, massage tub, and walk-in tub.

This limited warranty is valid for products that are either purchased brand new from an authorized Empava dealer or directly from Empava.

The effective date of the warranty commences from the date of original consumer purchase. If the appliance is installed, operated, and maintained in accordance with the user manual, Empava will provide parts at no cost to rectify any defects in materials and workmanship that were present at the time of purchase. Alternatively, at its sole discretion, Empava may replace the product. In the event of product replacement, the warranty for the replacement product shall be valid for the remaining term of the original warranty period.

DISCLAIMER OF IMPLIED WARRANTIES

IMPLIED WARRANTIES, INCLUDING ANY IMPLIED WARRANTY OF MERCHANTABILITY OR IMPLIED WARRANTY OF FITNESS FOR A PARTICULAR PURPOSE, ARE LIMITED TO ONE YEAR OR THE SHORTEST PERIOD ALLOWED BY LAW. Some states and provinces do not allow limitations on the duration of implied warranties of merchantability or fitness, so this limitation may not apply to you. This warranty gives you specific legal rights, and you also may have other rights that vary from state to state or province to province.

DISCLAIMER OF REPRESENTATIONS OUTSIDE OF WARRANTY

If you want a longer or more comprehensive warranty than the limited warranty that comes with this major appliance, you should ask Empava or your retailer about buying an extended warranty.

LIMITATION OF REMEDIES: EXCLUSION OF INCIDENTAL AND CONSEQUENTIAL DAMAGES -

HEREIN, EMPAVA SHALL NOT BE LIABLE FOR INCIDENTAL OR CONSEQUENTIAL DAMAGES. Some states and provinces do not allow the exclusion or limitation of incidental or consequential damages, so these limitations and exclusions may not apply to you. This warranty gives you specific legal rights, and you also may have other rights that vary from state to state or province to province.

WARNING!
CALIFORNIA RESIDENTS
Cancer and Reproductive Harm

AVERTISSEMENT!
RÉSIDENTS DE CALIFORNIE
Cancer et Dommages à la Reproduction

¡ADVERTENCIA!
RESIDENTES DE CALIFORNIA
Cáncer y Daño Reproductivo

www.P65W amngs.ca.gov

EMPAVA APPLIANCES INC.
458 Parriott Place West, City of Industry, California
91745, United States
TEL: 888-682-8882
WWW.EMPAVA.COM