

Yeego

YG-WF30-23

Who we are ?

Yeego, the perfect fusion of fashion and innovation. We are a factory seller specializing in wine cooler and beverage refrigerator.

We pursue fashionable design and innovative technology to create a space full of personality and modernity for you.

Whether you are a connoisseur who loves wine tasting, or a host looking to add unique charm to family gatherings, Yeego products can meet your needs. Choose Yeego, let us create a fashionable, innovative and wonderful life experience together.

 <https://yeegolife.com/>

 <https://www.facebook.com/yeegolife.official>

 <https://www.instagram.com/yeegolife.official>

TABLE OF CONTENTS

IMPORTANT SAFETY RULES	01
PARTS & TECHNICAL DATA	03
INSTALLATION INSTRUCTIONS	04
OPERATING YOUR APPLIANCE	07
TROUBLESHOOTING GUIDE	10
LIMITED WARRANTY	13

IMPORTANT SAFETY RULES

Before the appliance is used, it must be properly positioned and installed as described in this manual, so read the manual carefully. To reduce the risk of fire, electrical shock or injury when using the appliance, please follow basic precautions, including the following:

☆ DANGER

Plug into a grounded 3-prong outlet, do not remove grounding prong, do not use an adapter, and do not use an extension cord.

Replace all panels before operating. It is recommended that a separate circuit, serving only your appliance be provided. Use receptacles that cannot be turned off by a switch or pull chain.

Never clean appliance parts with flammable fluids. These fumes can create a fire hazard or explosion. And do not store or use gasoline or other flammable vapors and liquids in the vicinity of this or any other appliance. The fumes can create a fire hazard or explosion.

Before proceeding with cleaning and maintenance operations, make sure the power line of the unit is disconnected.

Do not connect or disconnect the electric plug when your hands are wet. Unplug the appliance or disconnect power before cleaning or servicing. Failure to do so can result in electrical shock or death.

Do not attempt to repair or replace any part of your appliance unless it is specifically recommended in this material. All other servicing should be referred to a qualified technician.

☆ WARNING

To ensure safe moving and installation of the appliance, it is recommended to have two or more individuals assist. Failure to do so can result in back or other injuries.

To ensure proper ventilation for your appliance, the front of the unit must be completely unobstructed. Choose a well-ventilated area with temperatures above 60°F(16°C) and below 90°F(32°C). This unit must be installed in an area protected from the element, such as wind, rain, water spray or drips.

The appliance should not be located next to ovens, grills or other sources of high heat.

The appliance must be installed with all electrical, water and drain connections in accordance with state and local codes. A standard electrical supply (115V AC only, 60Hz), should be properly grounded in accordance with the National Electrical Code and local codes and ordinances as required.

Do not kink or pinch the power supply cord of appliance.

The fuse (or circuit breaker) size should be 15 amperes.

It is important for the appliance to be leveled in order to work properly. You may need to make several adjustments to level it.

Never allow children to operate, play with or crawl inside the appliance.

Do not use solvent-based cleaning agents or abrasives on the interior. These cleaners may damage or discolour the interior.

Do not use this product for other than its intended purpose.

FLAMMABLE REFRIGERANT GAS

For your safety, observe the following recommendations.

This appliance contains a small quantity of R600a refrigerant which is environmentally friendly, but flammable. It does not damage the ozone layer, nor does it increase the greenhouse effect.

During transportation and installation, ensure that the tubing of the refrigerant circuit is not damaged.

Avoid using or manipulating sharp objects near by the appliances.

Leaking refrigerant can ignite and may damage the eyes.

In the event any damage does occur, avoid exposure to open fires and any device which creates a spark.

Disconnect the appliance from the mains power.

Thoroughly ventilate the room in which the appliance is located for several minutes.

Notify Customer Service for necessary action and advice.

The room for installing the appliance must be at least 1 cubic metre per 8 grams of refrigerant.

The refrigerant quantity contained in this appliance is listed above in grams, it is also noted on the Rating Plate of the appliance.

☆ DANGER

Risk of fire or explosion. Flammable refrigerant used.

DO NOT use mechanical devices to defrost refrigerator.

DO NOT puncture refrigerant tubing.

Flammable refrigerants have a risk of fire or explosion and should only be repaired by trained service personnel.

☆ WARNING

The use of flammable refrigerants is a fire or explosion hazard. Please refer to the Service Manual for guidance before attempting to service this product. All safety precautions must be followed.

Risk of fire or explosion: Dispose of property in accordance with federal or local regulations.

Risk of fire or explosion due puncturing of the refrigerant tubing. Follow handling instructions carefully.

To prevent a child from being entrapped, keep out of reach of children and not in the vicinity of the cooler.

To reduce the risk of fire, electrical shock, or injury when using your appliance, follow these basic precautions:

☆ WARNING

Read all instructions before using the appliance.

DANGER or WARNING: Risk of child entrapment.

Child entrapment and suffocation are not problems of the past. Junked or abandoned appliances are still dangerous.

Before you throw away your old appliance, take off the door but leave the shelves in place so that children may not easily climb inside.

Never allow children to operate, play with, or crawl inside the appliance.

Never clean appliance parts with flammable fluids. The fumes can create a fire hazard or explosion.

Do not store or use gasoline or any other flammable vapours and liquids in the vicinity of this or any other appliance. The fumes can create a fire hazard or explosion.

PARTS & FEATURES

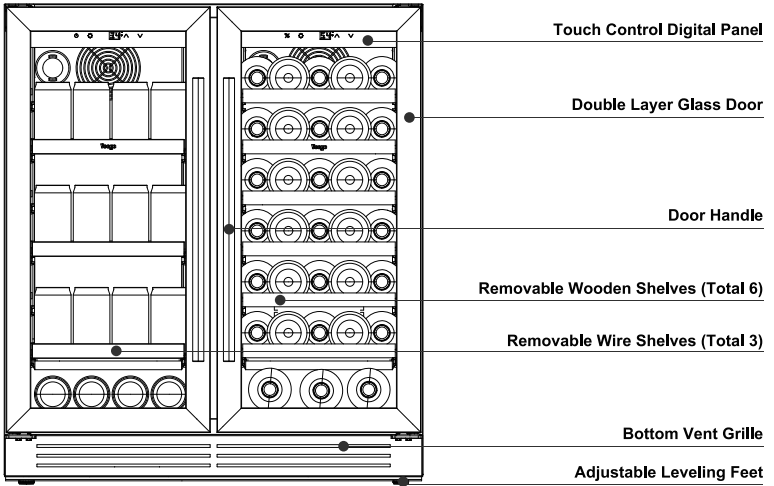

Technical Data:

Voltage:	115V/60Hz
Rated Current:	1.2A
Right Zone:	33 standard 750ml wine bottles
Left Zone:	80 standard 12 oz. cans min.
Temperature Range:	36°F-72°F (2°C-22°C)
Net Weight:	116.2 LB
Gross Weight:	148.2 LB
Unit Dimension:	29.7"W x 22.1"D x 33.8"H
Packaging Dimension:	33.5"W x 25.9"D x 42.5 "H
Refrigerant:	R600a

INSTALLATION INSTRUCTIONS

Before Using the Appliance

Remove the exterior and interior packing. Check to be sure you have all of the following parts:

6*Wooden Shelves and 3*Wire Shelves

2*Door Handles

4*Adjustable Leveling Feet

1*L-Shaped Screwdriver

1*Instruction Manual

Before connecting the appliance to the power source, let it stand upright for approximately 24–36 hours. It will reduce the possibility of a malfunction in the cooling system from handling during transportation.

Clean the interior surface using a soft cloth and lukewarm water.

Install the handle on the left side of the door.

Installation of the Appliance

This appliance is designed for freestanding or built-in (fully recessed) installation. Place the product on a floor strong enough to support it when fully loaded. Adjust the front leveling legs at the bottom to level the unit.

Please place the product away from direct sunlight and any heat sources such as stoves, heaters, or radiators. Direct exposure to sunlight may damage the acrylic coating, while nearby heat sources could increase energy consumption. Additionally, extremely cold temperatures may lead to improper performance of the unit. Do not install the unit in areas where the temperature could drop below 60°F (16°C), and avoid moist or damp locations.

For optimal performance, it is recommended that the appliance be installed in an environment with an ambient temperature between 66°F and 75°F. Temperatures outside this range may adversely affect the unit's performance.

Built-in Cabinet Instructions

For built-in installation, leave a (6 mm) space on each side and at the top of the appliance to ensure proper air circulation to cool the compressor and condenser. Also, ensure that no objects block the front exhaust vent, as this could impair the unit's performance. If the refrigerator is too short to fit securely in the cabinet, you can adjust its height using the leveling feet.

Cabinet Opening Dimensions

Minimum Width
30.0" (76.1 cm)

Minimum Depth
23.6" (59.9 cm)

Minimum Height
34.6" (87.9 cm)

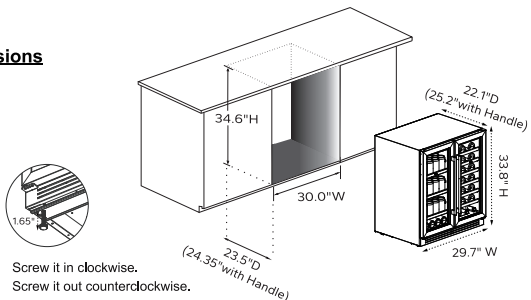

Electrical Connection

☆ WARNING

Improper use of the grounded plug can result in the risk of electrical shock. If the power cord is damaged, have it replaced by an authorized service center.

Proper grounding is essential for safety. The power cord has a three-prong plug for standard outlets to reduce electrical shock risk.

☆ NOTE

Plug the unit into an exclusive, properly grounded wall outlet. Do not under any circumstances cut or remove the third (ground) prong from the power cord. For personal safety, this appliance must be properly grounded. And any questions concerning power and/or grounding should be directed toward a certified electrician or an authorized service center.

The appliance should always be plugged into its own individual electrical outlet which has a voltage rating that matches the rating label on the appliance. This provides the best performance and also prevent overloading house wiring circuits that could cause a fire hazard from overheated. Never unplug the appliance by pulling the power cord. Always grip the plug firmly and pull straight out from the receptacle. Repair or replace immediately all power cords that have become frayed or otherwise damaged. Do not use a cord that shows cracks or abrasion damage along its length or at either end. When moving the appliance, be careful not to damage the power cord.

This appliance requires a standard AC115V/60Hz grounded outlet with three prongs. Have the wall outlet and circuit checked by a qualified electrician to make sure the outlet is properly grounded. Replace 2-prong outlets with properly grounded 3-prong outlets. The cord should be secured behind the appliance and not left exposed or dangling to prevent accidental injury.

Power bar with Surge Protection (Recommended)

Most electrical appliances operate via electronic control boards, which are highly susceptible to power surges and may sustain damage or complete failure.

If your location is prone to power surges/outages, it is strongly recommended to connect all devices to a surge protector. The protector must have a joule rating adequate for the connected appliance.

If you have any questions regarding the type and size of surge protector, you need to contact a licensed electrician in your area.

Extension Cord

To avoid potential safety hazards, do not use an extension cord with this appliance. If an extension cord is required, use a UL/CUL-listed, 3-wire grounding cord rated for 115 volts and at least 10 amperes.

Installing the Handle

This Appliance includes two door handles. To install the handle please follow the below instructions:

Step 1:

Remove the door gasket from the left side of the door (where the handle will be installed, as shown below). No tools are required—the gasket can be detached by hand. If needed, start peeling from a corner.

Step 2:

Insert the two handle screws, lock washer, and flat washer (included in the instruction manual bag) from the inside to the outside of the door.

Step 3:

Align the handle holes with the screws. Tighten the screws using a screwdriver until the handle base is flush with the door surface. Ensure the handle is secure but not overtightened to avoid assembly damage.

Step 4:

Reinstall the door gasket.

Note:

The Handle Screws (4) are packed with other accessories in the instruction manual bag. Please insert them into the door before installing the handle.

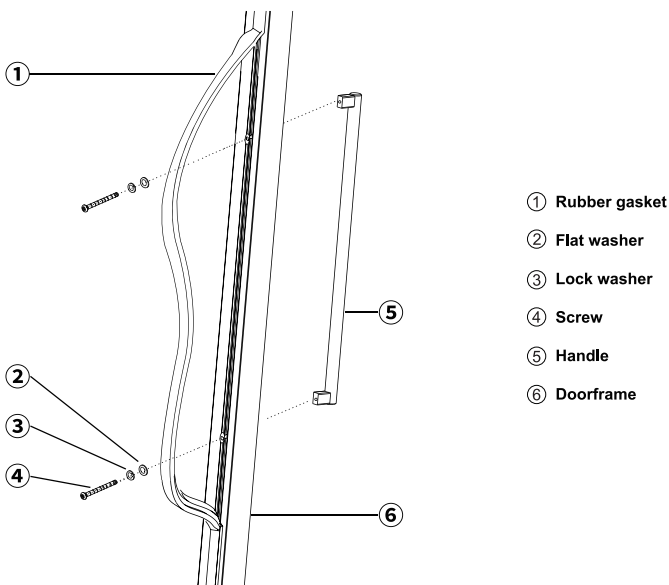

OPERATING YOUR APPLIANCE

It is recommended to install the Appliance in an area where the ambient temperature is maintained between 66°F and 75°F (19°C to 24°C). If the ambient temperature falls outside this range, the unit's performance may be compromised. For instance, exposure to extreme hot or cold conditions can lead to temperature fluctuations, and the target range of 36°F to 72°F (2°C to 22°C) may not be achieved.

Control Panel



ON/OFF:

To turn on or off the unit, press and hold the ON/OFF button for 5 seconds.

INSIDE LIGHTING:

To turn on or off the lighting, press on the light button.

TEMPERATURE DISPLAY:

Press & hold the light button for 5 seconds to switch the temp display between °C and °F.

 **BUTTON:** To increase the temperature by 1°C or 1°F

 **BUTTON:** To decrease the temperature by 1°C or 1°F

☆ NOTE

If the unit is unplugged, experiences a power loss, or is powered off, allow 3 to 5 minutes before restarting. Attempting to restart prematurely may cause the unit to fail to start.

When using the appliance for the first time or restarting it after prolonged shutdown, there may be a slight variance between the set temperature and the LED display reading. This is normal and occurs due to the initial stabilization period. After a few hours of operation, the temperature will stabilize.

★ NOTE

This product is designed for storing and cooling wine. It is not intended for storage of perishable foods.

Large Storage Capacity

The bottles and cans may vary in size and dimension, approximately 33 traditional Bordeaux 750ml bottles in right zone and 80 standard 12oz beverage cans in left zone.

Shelves

This appliance is equipped with 3pcs of wire shelves and 6pcs wooden shelves, you can move the shelves out and in smoothly.

To prevent damaging the door gasket, make sure to have the door all the way opened when pulling shelves out of the product. For easy access to the drinks, you must pull the shelves approximately 1/3 out of the cabinet.

POSSIBLE CAUSE

Wine Conservation	°C	°F
sparkling wines	5-8	40-47
Rose wines	10-11	49-51
Dry/white wines	9-14	48-57
Red wines	15-22	58-72

Moving the Appliance

- 1.Remove all items (drinks).
- 2.Tape down securely all loose items (shelves) inside your appliance.
- 3.Turn the adjustable leg up to the base to avoid damage.
- 4.Tape the door shut.
- 5.Be sure the appliance stays secure in the upright position during transportation. If you absolutely need to transport the refrigerator horizontally, transport the refrigerator on its back (door on top).
- 6.Protect outside of appliance with a blanket, or similar item.

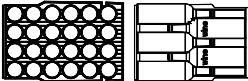

Total:80 Cans of 12oz Min.
33 Bottles of 750ml Bordeaux

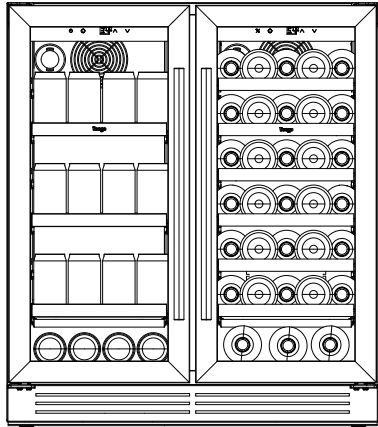

Cleaning the Appliance

Turn off the power, unplug the appliance, and remove all items including shelves. Wash the inside surfaces with a solution of 2 tablespoons of baking soda per 1 cup of warm water. Wash the shelves with a mild detergent solution. Wring excess water out of the sponge or cloth when cleaning area of the controls, or any electrical parts. Wash the outside cabinet with warm water and mild liquid detergent. Rinse well and wipe dry with a clean soft cloth.

Automatic Defrosting

The unit defrosts automatically. The evaporator behind the rear wall of the unit defrosts automatically. The condensate collects in the drainage channel behind the rear wall of the unit, and flows through the drainage hole into the drip tray by the compressor where it evaporates.

Power Failure

Most power failures are corrected within a few hours and should not affect the temperature of your appliance if you minimize the number of times the door is opened. If the power is going to be off for a longer period of time, you need to take the proper steps to protect your contents.

★ NOTE

Please disconnect the unit from its power source during operation to avoid exposing yourself to the risk of electric shock or personal injury.

Charcoal Filtration System

Your beverage refrigerator is equipped with an active charcoal filtration system to ensure air purity and to maintain an odour free cabinet for the storage of your wines. The filter is located at the bottom of the rear panel inside your cellar. Keep in mind, that this filter should be changed every 12 months.

Remove the bottles of wine stored on the two shelves in front of the filter.

Remove the shelves and set them aside for reinstallation after changing the filter.

Hold the filter and turn it at 45 degrees in the counter-clockwise direction and then pull it out.

Put the new filter into the hole and then turn the filter at 45 degrees in clockwise direction.

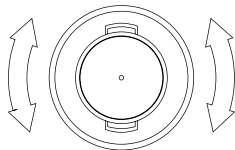

Energy Saving Tips

Place the beverage refrigerator in the coolest area, away from heat sources and direct sunlight. Ensure adequate space on all sides for proper ventilation. Never cover any air vents.

Minimize the time the door is open. Frequent opening will affect the internal temperature.

TROUBLESHOOTING GUIDE

Many common issues can be easily fixed yourself, potentially saving you a service call. Before contacting our support team, try the troubleshooting tips below to resolve the problem.

PROBLEM	POSSIBLE CAUSE	SOLUTION
Product does not operate.	Power cord is not plugged in. The unit is turned off. Circuit breaker tripped or a blown fuse.	Plug in the unit. Power on the unit. Check the circuit breaker and replace any blown fuses.
Product is not cold enough.	External environment may require a higher setting. The door is opened too often. The door is not closed completely. The door gasket does not seal properly.	Check the temperature control setting. Close the door properly. Check the door gasket.
The compressor turns on and off frequently.	The room temperature is hotter than normal. A large amount of contents has been added to the refrigerator. The door is opened too often. The door is not closed completely. The temperature control is not set correctly. The door gasket does not seal properly.	Close the door properly. Check the door gasket. Avoid frequent door openings.
The fans turn on and off frequently.	To ensure proper air circulation and maintain the set temperature inside the cabinet, the fans will automatically cycle on and off approximately every 20 seconds even when the compressor is not running. This normal operating condition, called 'Semi-Speed Mode', allows for continuous air movement and system protection. Please note that if the fans stop completely or fail to maintain this cycling pattern, this indicates a malfunction requiring service.	
Fan is always running	This is simply a function of the cooling system. The lower the temperature setting, the more the fan will run. In warmer rooms, the cooler will run more frequently. The unit is designed to run continuously at lower temperatures.	
The light does not work.	Power cord is not plugged in. Circuit breaker tripped or a blown fuse. The light button is "OFF".	Plug the unit. Press the power button to turn on the unit. Check the breaker and/or fuses.

PROBLEM	POSSIBLE CAUSE	SOLUTION
Vibrations.	The refrigerator does not be leveled The bottles are vibrating. There is an object under the refrigerator.	Check to ensure that the refrigerator is level. Make sure the bottles don't touch each others. Remove the object.
The product seems to make too much noise.	The unit is not level.	Level the refrigerator. The rattling noise may come from the flow of the refrigerant, which is normal. As each cycle ends, you may hear gurgling sounds caused by the flow of refrigerant in your refrigerator. Contraction and expansion of the inside walls may cause popping and crackling noises.
Display shows EL OR EH	The air temperature sensor in the corresponding temperature zone has failed	Call service center
The phenomenon of flashing lights	In some instances, this is normal. The light may flash when the automatic defrost function starts to work. This can happen if the set temperature is higher than the internal temperature.	Adjust temperature to resolve
Frost appears in cabinet (on back)	Excessive humidity or too low of temperature inside cabinet.	Unplug refrigerator and allow it to defrost manually. Reconnect when ice has melted. If problem persists, contact for service instructions.
The door will not close properly.	The refrigerator is not level. The door was reversed and not properly installed. The gasket is dirty. The shelves are out of position.	Level the refrigerator. Close the door properly. Clean the door gasket. Place the shelves properly.

If the above problems occur and cannot be solved by following the instructions, please contact us by email: service@yeegolife.com Please describe your problems in detail in words, pictures or videos, and we will answer for you as soon as we receive your feedback.

PROBLEM	POSSIBLE CAUSE	SOLUTION
Display shows: E1, E2, E5, E6, E7, E8, E9, EA, EU	Temperature sensor failure or communication error	Please call the service center.
L0	Low temperature alarm	Please call the service center.
HI	High temperature alarm	Please confirm whether the internal and external fans are operating and whether the compressor is running. If both the fans and compressor are functioning but the temperature is not correct, the temperature sensor may be faulty. If the internal fan is not turning, it may indicate a fan malfunction. If you encounter any of the above issues, please contact the customer service center for assistance.
Et	Temperature difference alarm	Please turn off the unit and unplug the power supply. Leave the door open for ventilation for 24–36 hours to allow the error to clear. If the issue persists after ventilation, you may carefully remove the back panel of the internal fan to check for ice buildup. Once the ice has fully melted, restart the unit and set the desired temperature. It is recommended not to set the temperature to the minimum at this time.
E0	The door is not closed properly	Make sure the door is tightly closed. If the door is not properly closed, close it securely. If the issue persists, please contact customer service for assistance.

LIMITED WARRANTY

1 Year Warranty Parts

For a year (12 months) from the purchase by the original owner, we would provide accessories to replace any part of the unit which proves to be defective in material or workmanship, with installation video or online guide. You could also contact us by email to get a solution.

During this period we will provide all parts necessary to correct such defects free of charge, so long as the unit has been installed and operated in accordance with the written instructions in this manual.

3 Year Warranty Compressor

For the 2nd through the 3rd year from date of original purchase, we will provide a replacement compressor free of charge due to a failure. You are responsible for the service labour and freight charges. Cost to move the wine cellar to the servicers' shop and back to the user's home, as may be required, are the user's responsibility.

What Is Not Covered

Damage due to such things as accident, misuse, abuse, mishandling, neglect, acts of God, fires, earthquakes, floods, high winds, government, war, riot or labour troubles, strikes, lockouts, delay of carrier, or any cause beyond the control of the Seller whether similar or dissimilar to the foregoing.

Content losses due to spoilage. Incidental or consequential damages. Parts and labour costs for the following will not be considered as warranty:

- ° Door springs, and/or frames.
- ° Inner door panels, door rails and/or door supports.
- ° Light bulbs and/or plastic housing.
- ° Plastic cabinet liners.

Punctured evaporator that voids the warranty on the complete sealed system.

Repairs performed by unauthorized servicers. Damage caused by external influences.

Excess wear and tear by the user. Service calls that do not involve defects in material or workmanship such as customer education, door reversal, or proper installation.

Service calls that are related to external problems, such as abuse, misuse, inadequate electrical power, accidents, fire, floods, or acts of God. Replacement of house fuses or resetting circuit breakers. Failure of the product if it is used for other than its intended purpose.

This warranty does not apply outside Canada or the Continental USA.

Purchaser understands and acknowledges that the goods purchased are appliance, which store wines. Purchaser assumes all risk of using this unit, including risk of spoilage, humidity variations, temperature variations, leaks, fire, water damage, mold, mildew, dryness, and

CUSTOMER SERVICE

Read This Guide Carefully.

It is intended to help you operate and maintain your new wine cellar properly. Keep it handy to answer your questions.

Keep proof of original purchase date (such as your sales slip) with this guide to establish the warranty period. Save time and money. Before you call for service, check the Troubleshooting Guide. It lists causes of minor operating problems that you can correct by yourself.

Purchase Date :

Model Number :

Serial Number :

Contact Us

We're proud of our service and want you to be pleased. If for some reason you are not happy with the service you receive, here are some steps to follow for further assistance.

First, contact the people who serviced your appliance.

Explain why you are not pleased. In most cases, this will solve the problem.

Please feel free contact us by after-service email address (**service@yeegolife.com**)

Next, if you are still not pleased, fill in all the detailed information, including your telephone number and send it to us :

Address	
Phone	
Fax	
Email	
Online	

Activate Warranty & Join Us

VISIT: <https://yeego.vip/>
or scan the QR code



Email: service@yeegolife.com

*Activate Product Warranty

*VIP Exclusive Service

*Personalized product care & records

Just let us know if you have any questions about our products!