







ASSEMBLY INSTRUCTIONS

Remarks: Do not tighten screws until completely assembled.

NO	Description	Drawing	Size	Q'ty
A	Spring Washer		Ø M12mm	20 pcs
B	Flat Washer		Ø M18mm	20 pcs
C	JCBC SCREW		Ø M6X90mm	8 pcs
D	JCBC SCREW		Ø M6X70mm	8 pcs
E	JCBC SCREW		Ø M6X60mm	4 pcs
F	Allen Key			1 pc

Step 1

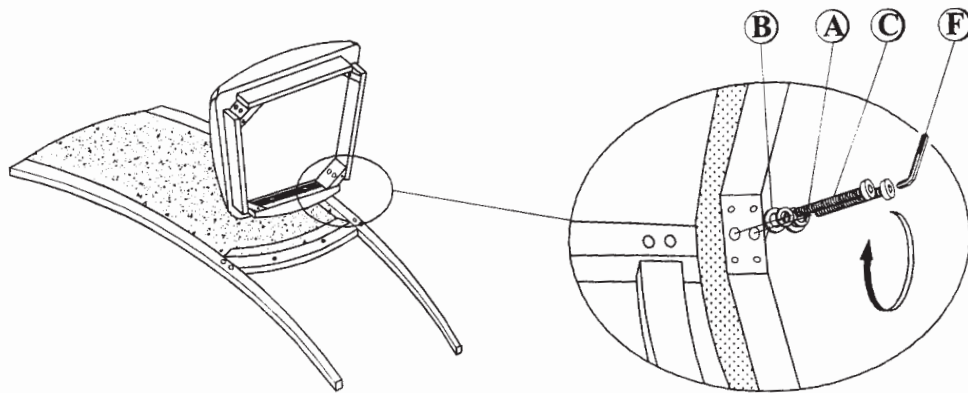

Step 2

