

ASSEMBLY INSTRUCTION

Friendly Reminder:

- 1.This sofa is packed in 5 boxes. Please assemble it After all boxes are received.
- 2.As the cushions are all vacuum compressed,there will be some wrinkles. Please give your cushions up to 72 hours to reach its original size and the wrinkles will basically disappear.
- 3.Please do not open the compressed packages until your sofa frame is completely assembled.

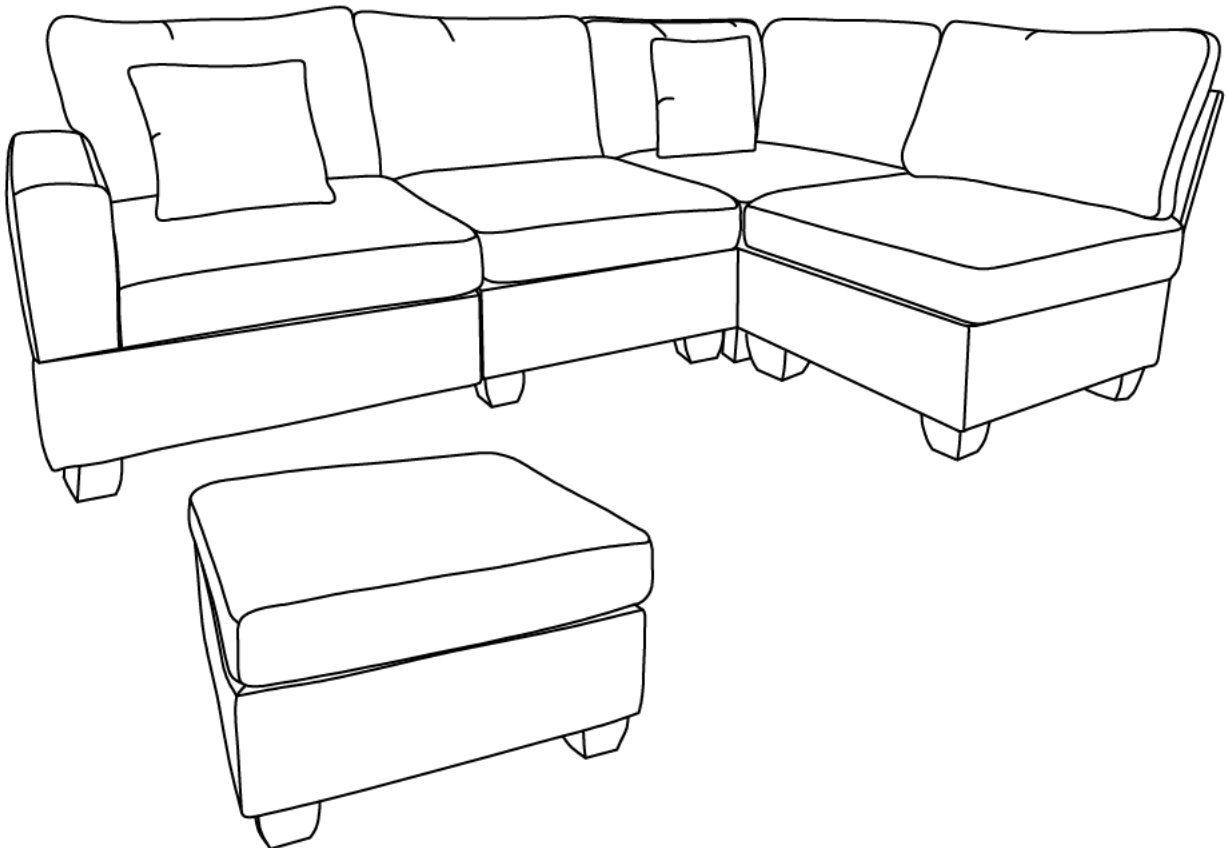







Return & Warranty policy:

- We strive to offer the highest quality products,and we also try our best to satisfy each and every customer that orders from us with replacement parts or service as needed.
- If the item is damaged or defective, please take photos as evidence for replacements and refunds.
- Please do not return to store,contact the seller if you have any troubles with this product.

ASSEMBLY INSTRUCTION

HARDWARE



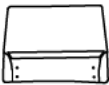
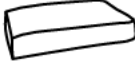

NO	DESCRIPTION	SKETCH	QTY
1	Washer		32
2	Screws 8X60		20
3	Screws 8X80		6
4	Butterfly nut		6
5	Wrench		1
6	Plastic gasket		20
7	Insert		2

PARTS LIST





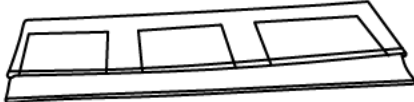

NO	DESCRIPTION	SKETCH	QTY
A	Seat frame		1
G	Back frame		5
H	Seat cushion		1

ASSEMBLY INSTRUCTION







PARTS LIST





NO	DESCRIPTION	SKETCH	QTY
B	Seat frame (left)		1
H	Seat cushion		1
J	Back cushion		1
M	Back cover (long)		1
O	Leg		4
Q	Pillow		1

PARTS LIST

NO	DESCRIPTION	SKETCH	QTY
C	Seat frame (right)		1
J	Back cushion		1
H	Seat cushion		1
N	Back cover (short)		1
O	Leg		4
Q	Pillow		1

ASSEMBLY INSTRUCTION

PARTS LIST			
NO	DESCRIPTION	SKETCH	QTY
D	Corner seat frame		1
I	Corner seat cushion		1
K	Corner back cushion (left)		1
L	Corner back cushion (right)		1
O	Leg		4
P	Armrest (left)		1

PARTS LIST			
NO	DESCRIPTION	SKETCH	QTY
E	Ottoman seat frame		1
F	Ottoman cushion		1
O	Leg		8
J	Back cushion		1

ASSEMBLY INSTRUCTION

All parts and hardwares.

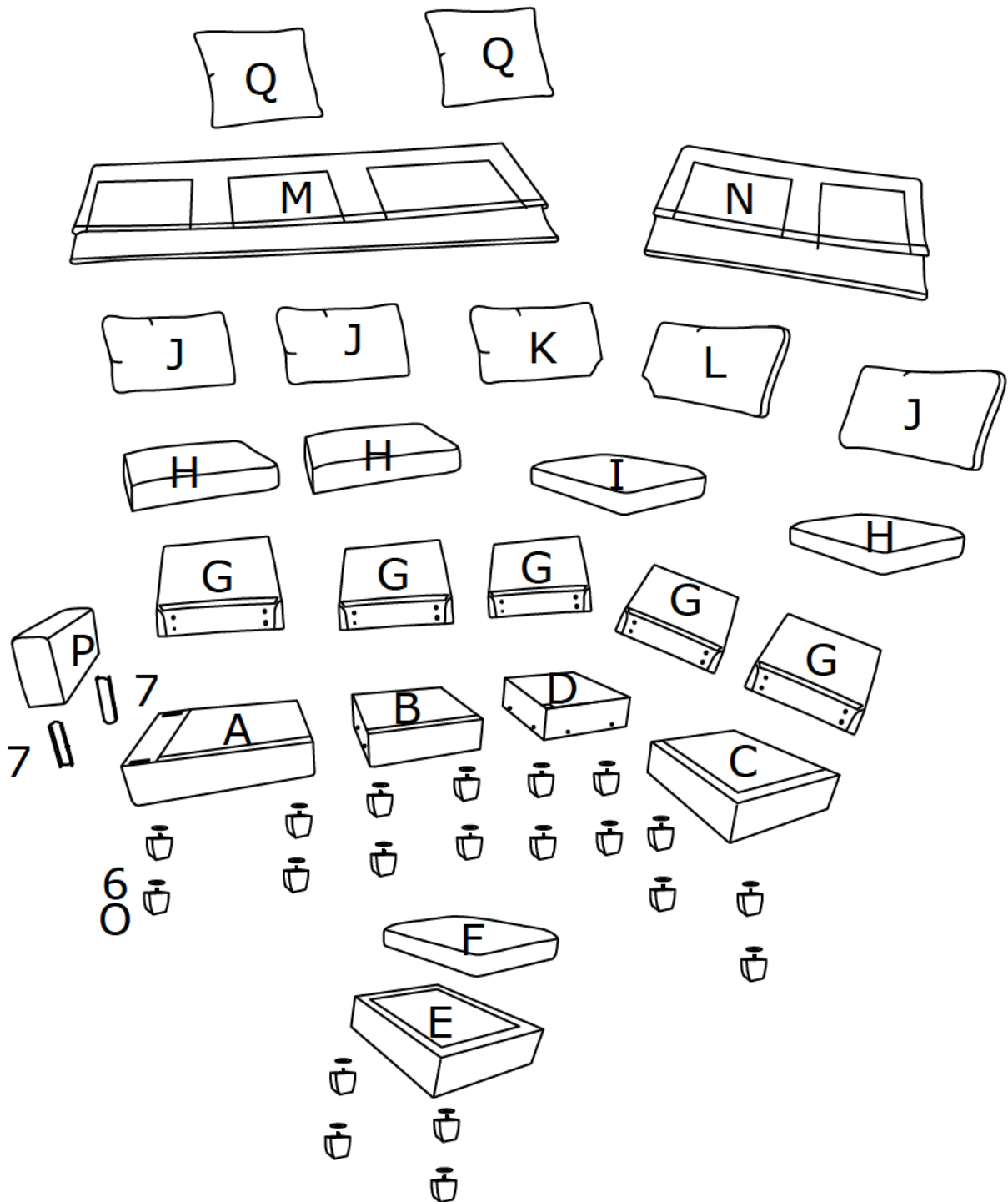

DIAGRAM 1 (Take out all parts)

Take the Back frame (Parts G) Seat cushion (Parts H) out of the Seat frame (Parts A).

Take the Seat cushion (Parts H) Back cushion (Parts J) Leg (Parts O) Pillow (Parts Q) out of the Seat frame (left) (Parts B).

Take the Seat cushion (Parts H) Back cushion (Parts J) Leg (Parts O) Pillow (Parts Q) out of the Seat frame (right) (Parts C).

Take the Armrest (left) (Parts P) Corner seat cushion (Parts I) Corner back cushion (left) (Parts K) Corner back cushion (right) (Parts L) Leg (Parts O) out of the Corner wood frame(Parts D).

Take the Ottoman cushion (Parts F) Back cushion (Parts J) Leg (Parts O) out of the Ottoman frame (Parts E) .

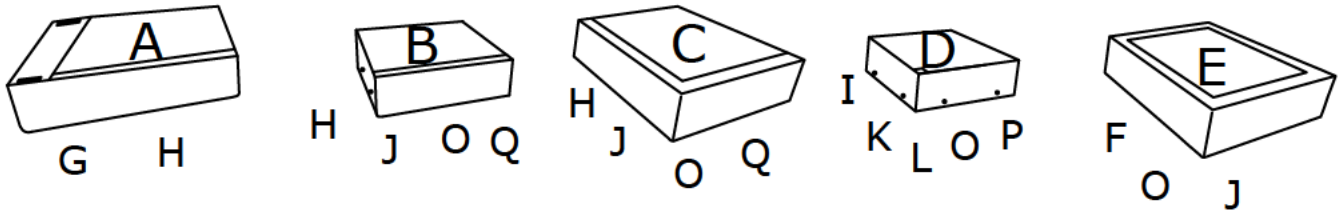

DIAGRAM 2 (Assemble the Seat frame)

Connect Seat frame (Parts A) and Seat frame (left)(Parts B) and Seat frame (right)(Parts C) with the Corner seat frame(Parts D) with Screws M8X80 (Hardware 3)and the Butterfly nut (Hardware 4) and the Washer (Hardware 1) by Wrench (Hardware 5).

1		12PCS
3	 M8X80	6PCS
4		6PCS

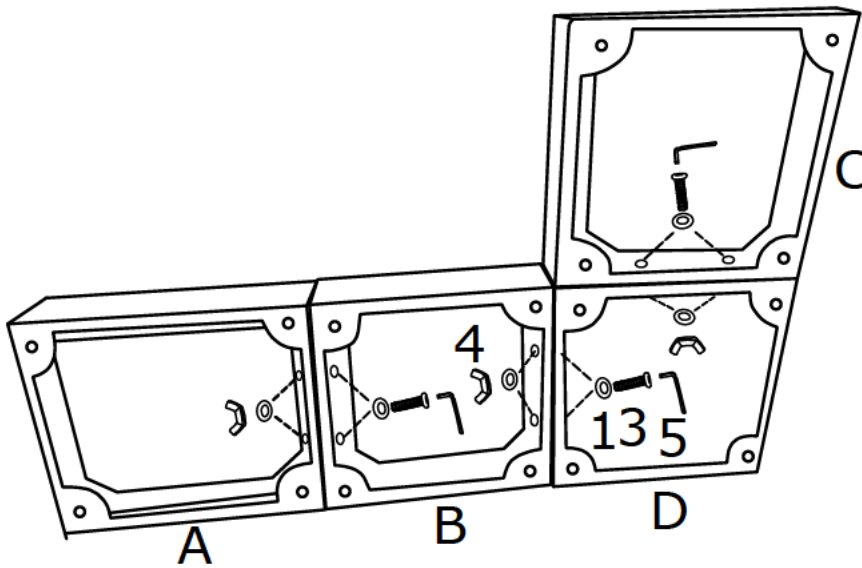



DIAGRAM 3 (Assemble the Legs)

Tighten 2 0 Legs (Parts 0) by Plastic gasket(Hardware 6).

6		20PCS
0		20PCS

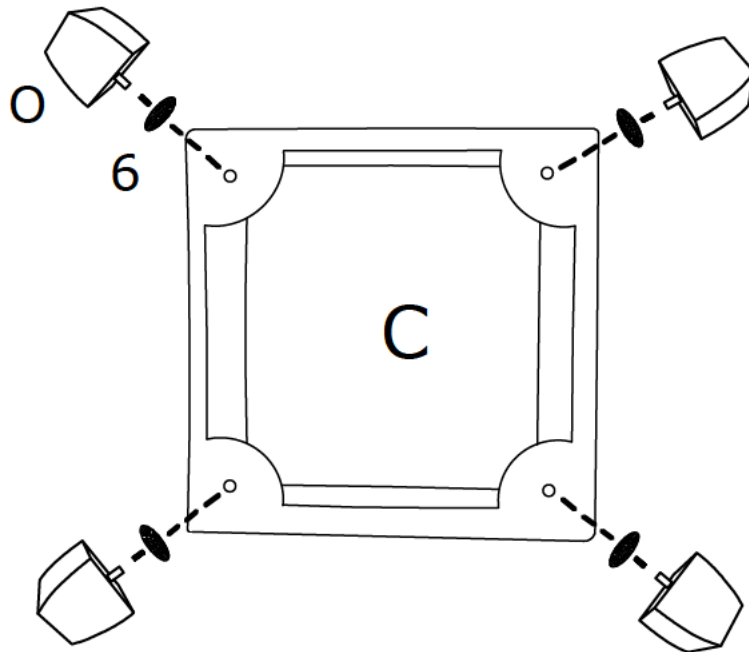
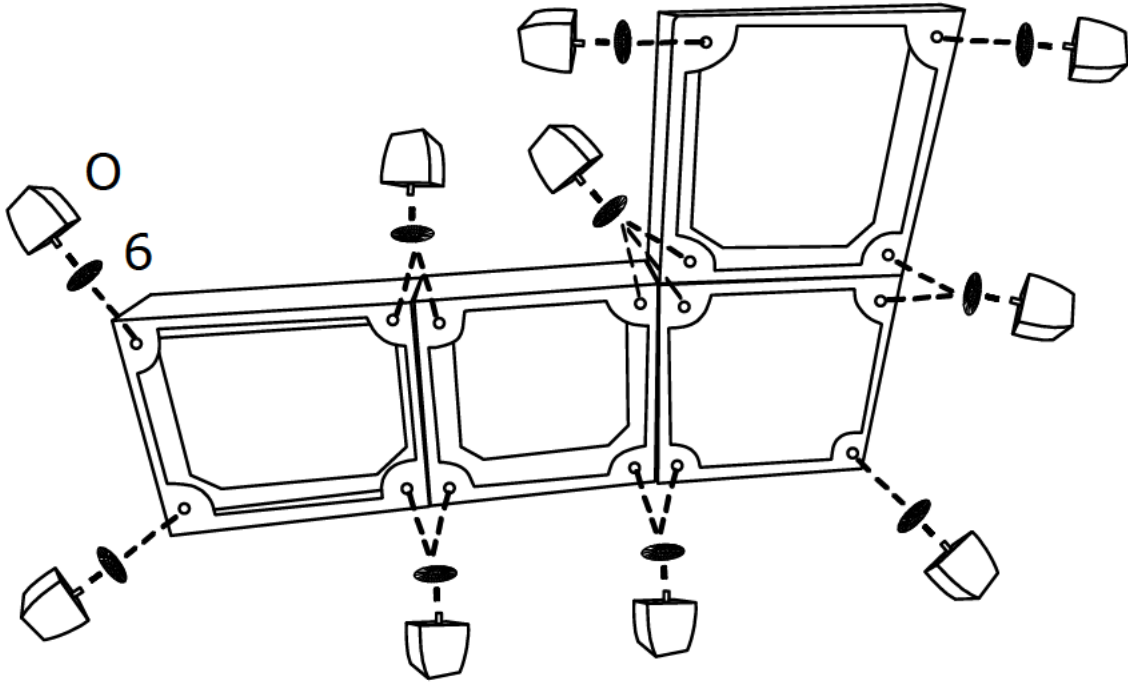



DIAGRAM 4 (Assemble the Back frame)

Connect the Back frame (Parts G) with the Screws M8X40 (Hardware 2) and Screws M8X60(Hardware 2) with the Washer(Hardware 1) by Wrench (Hardware 5).

1		20PCS
2	 M8X60	20PCS

Please install the top screws first, then the bottom screws.
Make sure all the screws are in the holes before tightening all the screws.

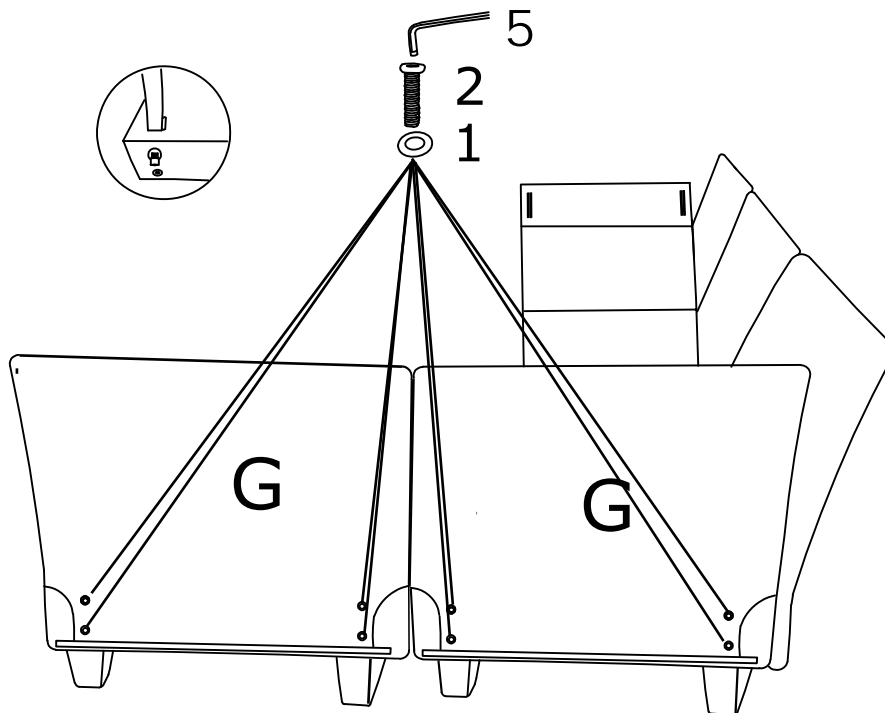
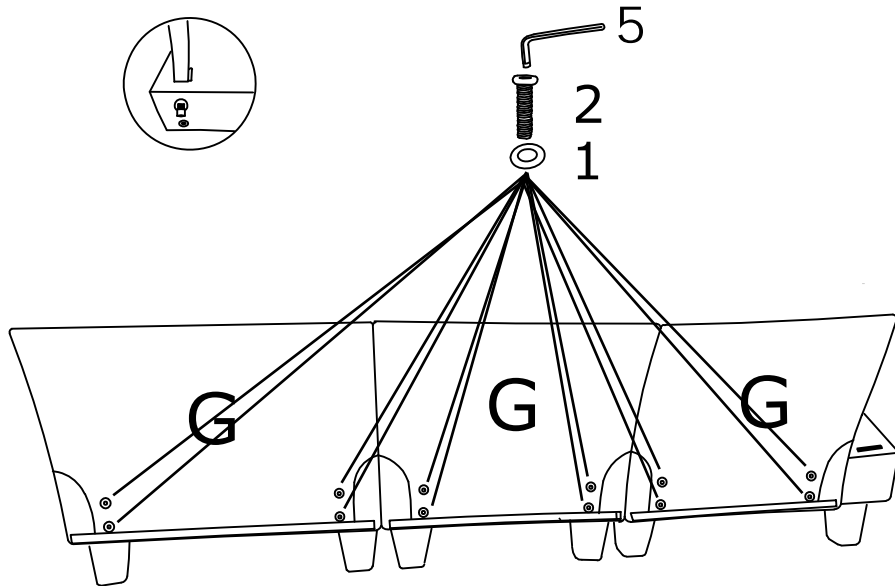

DIAGRAM 5 (Put the Back cover on the Back frame)

Place the Back cover (short) (Parts N) and Back cover (long) (Parts M) on the Back frame.

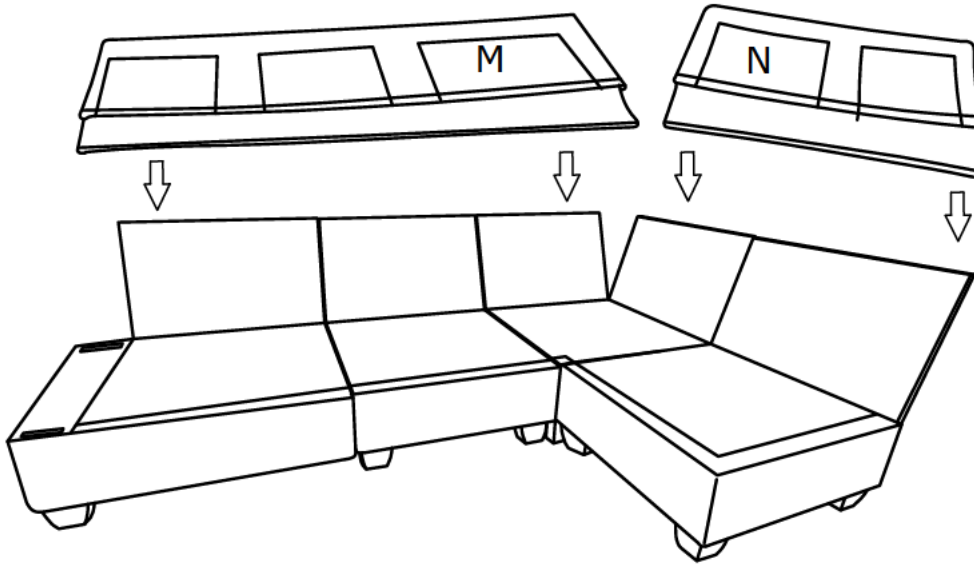

DIAGRAM 6 (Assemble the Armrest (left))

Insert the Insert (Parts 7) into the Armrest (left) (Parts P) .

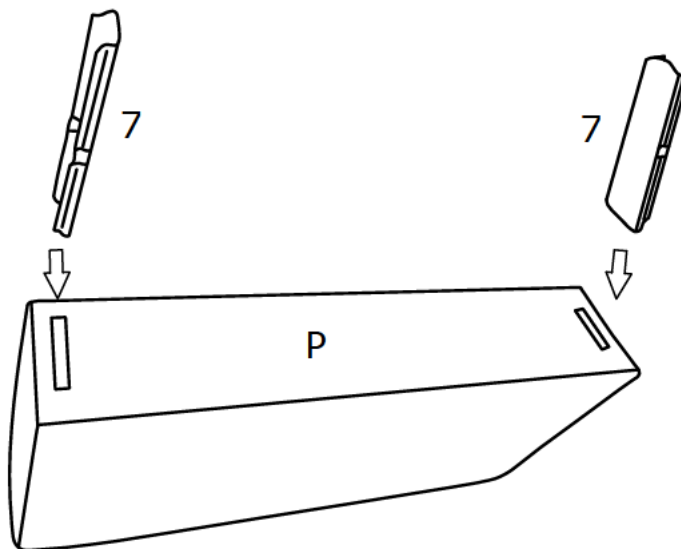

DIAGRAM 7 (Assemble the Armrest (left))

Insert the Armrest (left) (Parts P) into the Seat frame (Parts A) .

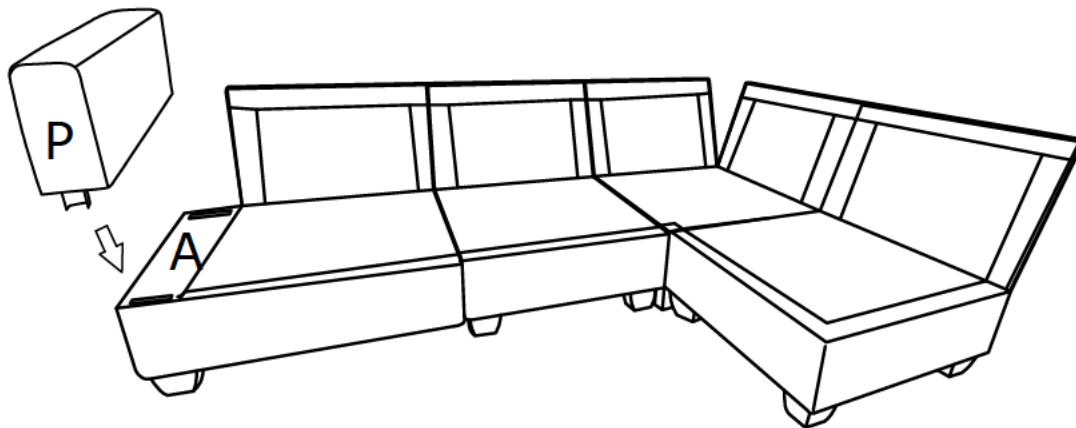
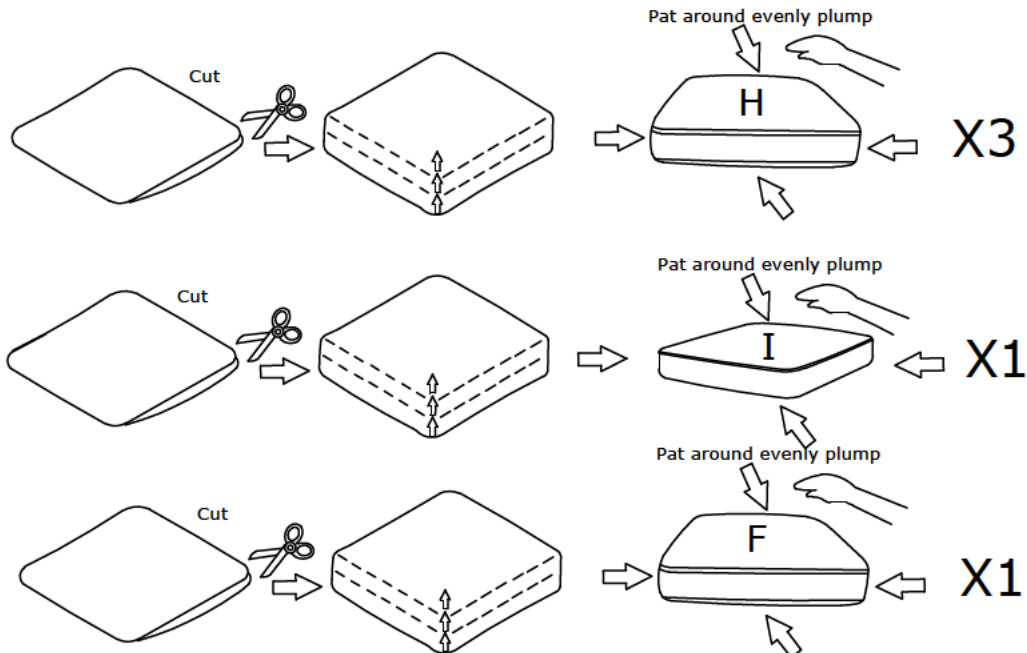

DIAGRAM 8(Removal of compression bags)

Remove the Seat cushion(Parts H)the Corner seat cushion(Parts I) the Ottoman cushion(Parts F) .



TIPS

1. Please do not open the compressed packages until your sofa frame is completely assembled.
2. Compressed back cushions and pillows need to be fully fulfilled within 72 hours for your perfect use.
3. Please keep children away from plastic bags or any small pieces of stuff.

DIAGRAM 9 (Place the Seat cushion on the sofa)

Put the Seat cushion (Parts H) Corner seat cushion (Parts I) on the sofa.

Recheck all the bolts before you sit on the sofa.

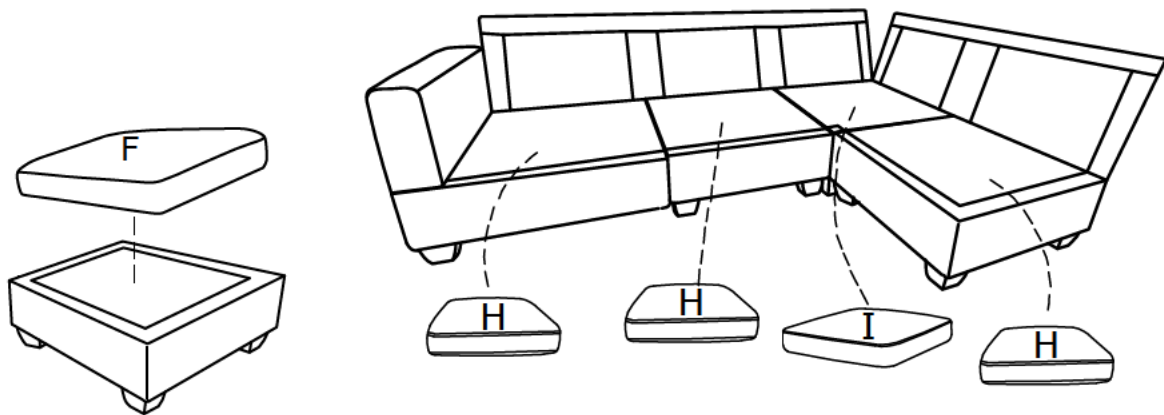
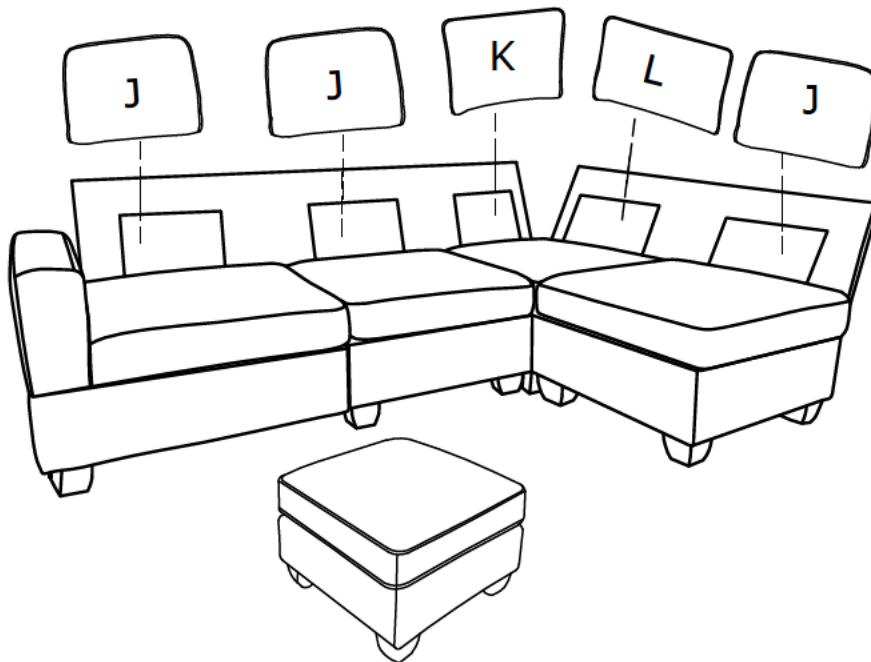

DIAGRAM 10 (Place the Back cushion on the sofa)

Put the Back cushion (Parts L) Corner back cushion (left) (Parts M) Corner back cushion (right) (Parts N) on the sofa.



TIPS:

1. Please do not open the compress packaging until your sofa frame is completely assembled.
2. Compress back cushions and pillows need to be fully fulfilled within 72 hours for your perfect use.
3. Please keep children away from plastic bags or any small pieces of stuff.

