

## Features

- 27" (686 mm) minimum base cabinet width.
- Single bowl.
- 5-1/4" depth.
- Basin slopes toward drain to minimize water pooling.
- Offset drain increases workspace in the sink and storage space underneath.

## Material

- KOHLER® enameled cast iron.

## Installation

- Top-mount.

## Recommended Products/Accessories

- K-6238 Sink Rack
- K-8801 Sink drain and strainer with tailpiece
- K-8799 Sink drain and strainer basket
- K-23726 Drain treatment
- K-23725 Cast iron cleaner

## Optional Products/Accessories

- K-11352 Disposal Flange with Stopper
- K-9000 P-Trap



**ADA**

## Codes/Standards







ASME A112.19.1/CSA B45.2  
ADA  
ICC/ANSI A117.1

## KOHLER® Enameled Cast Iron Kitchen Sink Lifetime Limited Warranty

See website for detailed warranty information.

## Available Colors/Finishes

*Color tiles intended for reference only.*

Color	Code	Description
	0	White
	FF	Sea Salt™
	96	Biscuit
	95	Ice™ Grey
	K4	Cashmere
	7	Black Black™

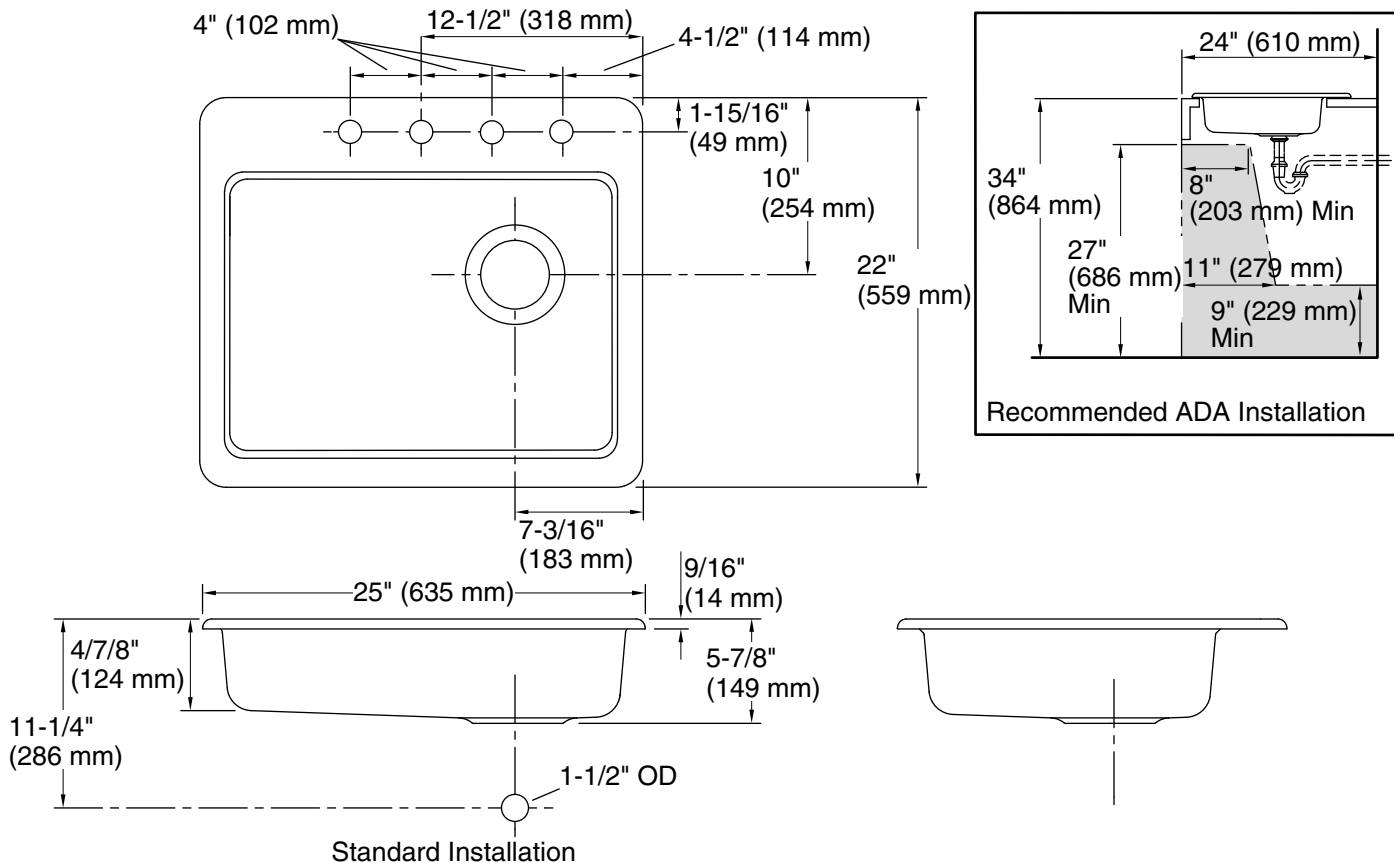

## Technical Information

All product dimensions are nominal.

Installation:	Top-mount
Center(s):	4
Min. base cabinet width:	27" (686 mm)
Bowl area (Only):	Length: 22-1/4" (566 mm) Width: 17-1/4" (438 mm) Bowl depth: 5-1/4" (133 mm) Water depth: 5-1/4" (133 mm)
Number of deck holes:	4
Faucet hole spacing:	4" (102 mm)
Template:	1172565-7, required, included

## Notes

Install this product according to the installation instructions.

**NOTICE:** Countertop manufacturer or cutter must use the cut-out template provided with the product, or a current one provided by Kohler Co. (call 1-800-4-KOHLER). Kohler Co. is not responsible for cutout errors when the incorrect cut-out template is used.

ADA compliant when installed to the specific requirements of these regulations.