

STU2FABCR2



Product family	Dishwashers
Width	24"
Commercial height	82 cm
Installation	Under counter built-in
N° baskets	3, FlexiDuo
Engine	Single phase
EAN code	8017709303624



Programs / Functions



Number of programs	10	Delicates	Yes
Washing temperatures	38, 45, 50, 55, 65, 70, 75 °F	Auto	Yes
Soak	Yes	Crystal & China	Yes
Express 27'	Yes	Eco express	Yes
Mix	Yes	Express 60'	Yes
Sterilize	Yes	Pots & Pans	Yes

Options



Dry Assist option	Yes	FlexiZone half-load option	Yes
Delay start	Up to 9 hours	Special programs option	Yes

Baskets



Basket components finish	Gray	Largest loadable dish in upper basket	23,5 inches
Upper basket	1 foldable rack	Lower basket	With 2 foldable racks
Glass holder	Yes	Lower basket with anti-drip inserts	Yes
Upper basket height adjustment	On 3 levels	Largest loadable dish in lower basket	30,0 inches

Sliding Guides Extra
Glide Yes

Cutlery basket Yes

Technical Features



Width 23 9/16 "
 Depth 21 7/16 "
 Display type LED display (1 digit)
 Height 32 3/16 "
 Display Delay start
 Program symbols Symbols
 On/off indicator Yes
 Salt indicator Light
 Rinse aid indicator Light
 End-of-cycle indicator Acoustic signal
 Washing system Planetarium
 Third spray arm Single
 Water softener With electronic setting
 Turbidity sensor Yes
 Aquatest

Flood protection system Total Aquastop
 Max water hardness 100°FH;58°dH
 Drying system Natural condenser drying,
 with Dry Assist automatic
 door opening system at the
 end of the cycle
 Tub material Stainless steel
 Filter Stainless steel
 Concealed heating
 element Yes
 Hinges Self-balancing with fixed
 hinges
 Min. and max plinth
 height 3.9" - 6.6"
 Adjustable feet 2 3/4", from 32 1/4" to 35"
 Additional gaskets Yes
 Back cover Yes
 Depth of dishwasher
 with open door (mm) 1146
 Top cover Metal sheet

Electrical Connection

Plug (A) USA & Mexico
 Connected power 1800 W
 Current 13 A
 Voltage 115 V

Frequency (Hz) 60 Hz
 Connection type Single-phase
 Power supply cable
 length 140 "

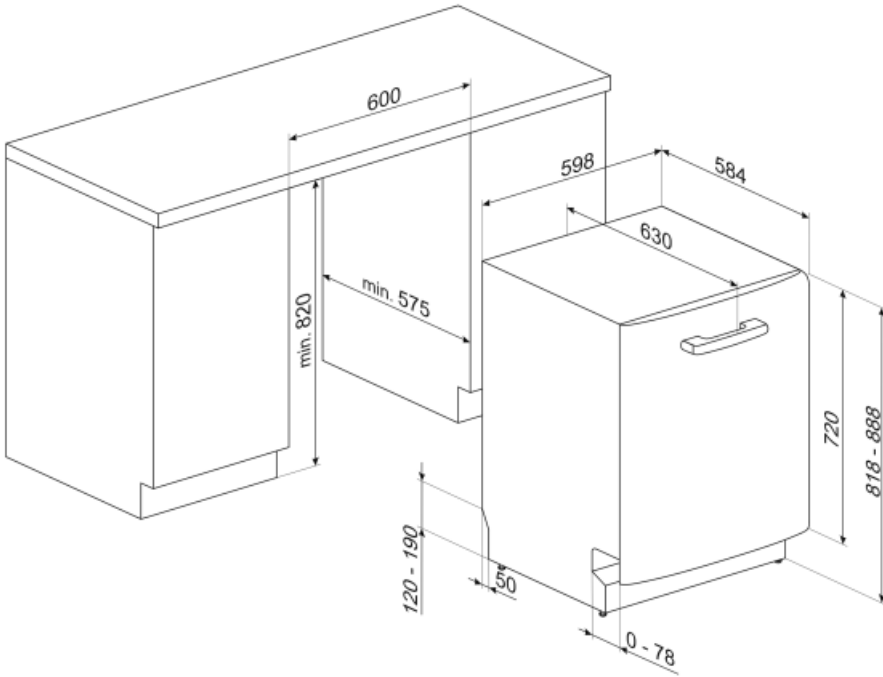

Not included accessories

KITPL60FABB



Toe kick Kit in White colour with adjustable height. Can be fitted over all the fully integrated and underbench models with Fixed Fulcrum. Can be installed also on the models with variable fulcrum or flexifit hinges.

KITPL60FABN



Toe kick Kit in Black colour with adjustable height. Can be fitted over all the fully integrated and underbench models with Fixed Fulcrum. Can be installed also on the models with variable fulcrum or flexifit hinges.

KITGH

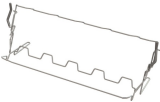

Kit glass holder. It has to be fitted on the first basket but only if there are foldable racks

KITPL60FABX



















Toe kick Kit in Stainless Steel with adjustable height. Can be fitted over all the fully integrated and underbench models with Fixed Fulcrum. Can be installed also on the models with variable fulcrum or flexifit hinges.

KITPLV2



Kit extension for dishwasher and washing machine: lenght mt. 2

Symbols glossary (TT)

	Aquatest measures the clarity of the water during an auto program, and automatically ensures the minimum consumption of water and energy.		Anti-drip: Some models of dishwashers are equipped with special polymer nozzles anti-drip, that improve the process of drying.
	COMM_HEIGHT_82_72dpi		Delay Timer: The delay timer can postpone the start of the program by up to 24 hours.
	Energysave: At the end of the drying cycle a special device slowly automatically opens the door a few centimeters, to ensure perfect drying and to save up to 20% of energy on some models.		FlexiDuo: The FlexiDuo 3rd cutlery basket allows you to arrange cutlery or small cups, ladles, or bulky utensils however you like: it consists of two separate and moveable modules.
	FlexiZone: The 1/2 load flexizone allows you to wash a reduced load saving energy, water and time and there are no restrictions on where the items are placed.		The new ExtraGlide guide system, available on top of the range models, makes the second basket even smoother and softer. In fact, it facilitates the extraction of the introduction, even at full load and, for the greater excursion, the insertion of crockery is also facilitated in the rear part.
	Noise Level: Excellent insulation and special devices keep noise to a minimum.		PLANETARIUM_WASHING_SYSTEM_72dpi
	Delicate: Delicate washing program is designed for delicate dishes which are not heavily soiled.		Delicate: Delicate washing program is designed for delicate dishes which are not heavily soiled.
	Normal programme: The normal programme is suitable for normal degrees of dirt for everyday use.		Soak programme: The soak programme provides a rinse to prevent dirt from drying.
	Rapid 27 Mins: The rapid 27 mins quick program takes just 27 minutes to wash a load.		The symbols show the number of plate settings of the dishwasher.
	Total Acquastop: In addition to the partial Acquastop protection present in all Smeg dishwashers, some models have an electronic device fitted to the water intake hose, which monitors water levels in the machine, detects leaks in the hose and switches off the water supply immediately when necessary.		...
	...		