























# Assembly Instruction

(BOX 1) HEADBOARD, FOOTBOARD, SIDE RAIL			(BOX 1) HARDWARE LIST		
NO	ITEM	QTY	NO	ITEM	QTY
A	HEADBOARD 	1 PC	1	JCBC NO HEAD 	4 PCS
B	FOOTBOARD 	1 PC	2	JCBB M8 x 30MM 	8 PCS
C	SIDE RAIL 	4 PCS	3	JCBC M6 x 30MM 	8 PCS
D	SLAT 1397mm 	2 PCS	4	JCBC M6 x 60MM 	4 PCS
E	CENTER RAIL 800mm 	2 PCS	5	M4 x 65MM 	1 PC
F	LEG Wooden Leg R/W 40 x 70 x 197-50(H) 	4 PCS	6	M5 x 70MM 	1 PC
G	SUPPORT LEG 250mm 	4 PCS	7	FLAT HEAD CHIPBOARD SCREW M4 x 32MM 	24 PCS
H	SIDE RAIL LEG 24 x 80 x 290 	2 PCS	8	PLASTIC DOWEL 	8 PCS
			9	M6 FLAT WASHER 	8 PCS
			10	M6 SPRING WASHER 	8 PCS
			11	CAP NUT 	4 PCS
			12	NUT 	4 PCS
			13	SPANNER 	1 PC
			14	SMALL ADJUSTER 	4 PCS

Step 1 : Tighten the legs (E) to the headboard (A) and footboard (B) as shown.

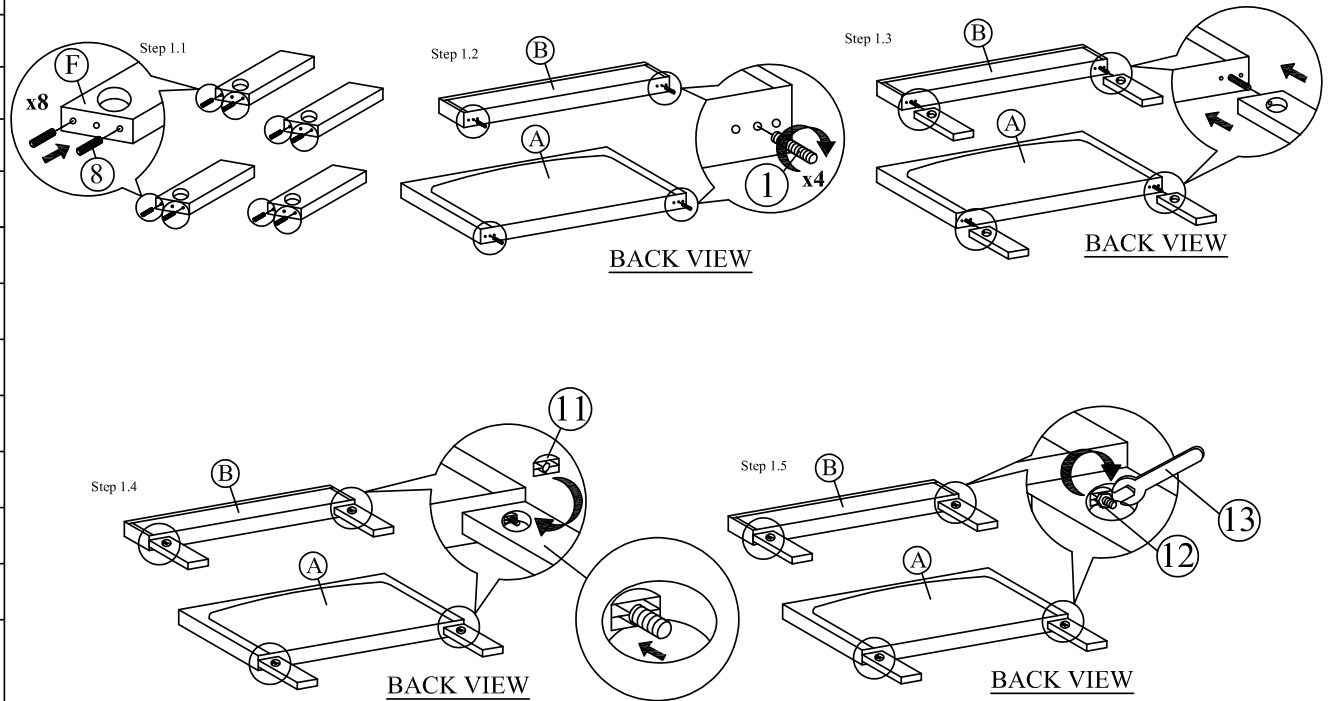

Step 2 : Attach the side rail leg (H) to the side rail (C).

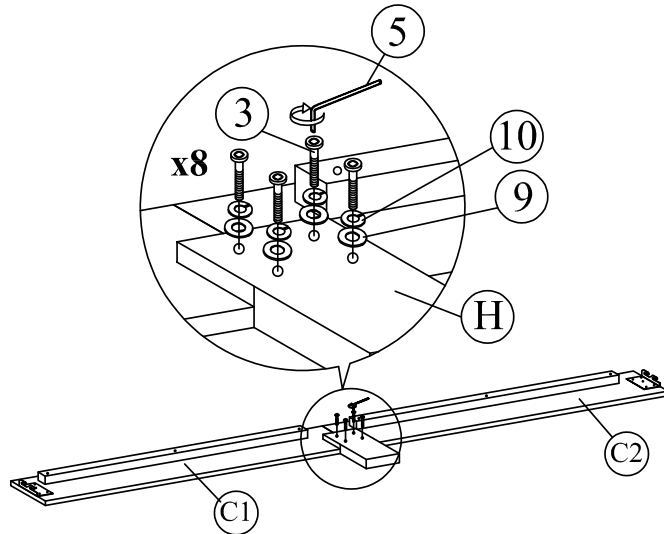

Step 3 : Attach side rail (C) to headboard (A) and footboard (B) by pushing the bracket down to fit it.

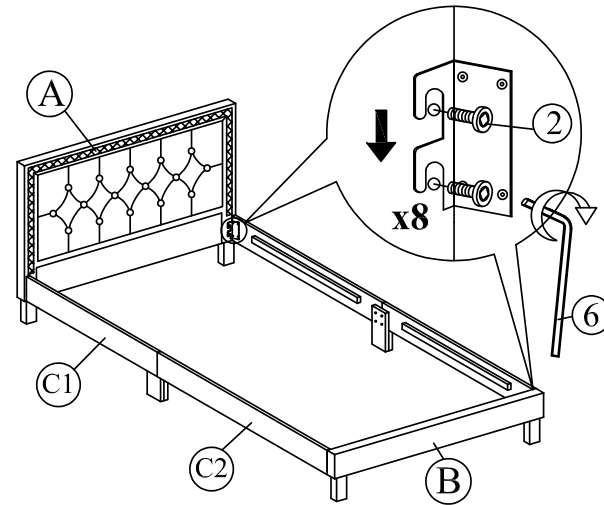

Step 4 : Attach the support legs (G) to the slats (H).

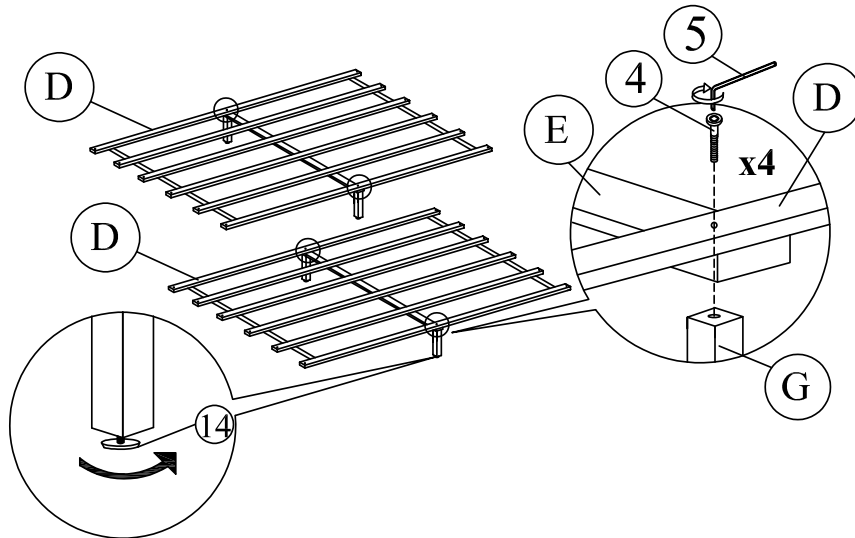

Step 5 : Tighten the 4 Corner with Allen Key (6). Install the bed slats to side rail. Tighten the slats with CSK screw. The distance of the slats should be sufficient to obtain desirable bed stability.

