

Massage Office Chair Assembly Instruction

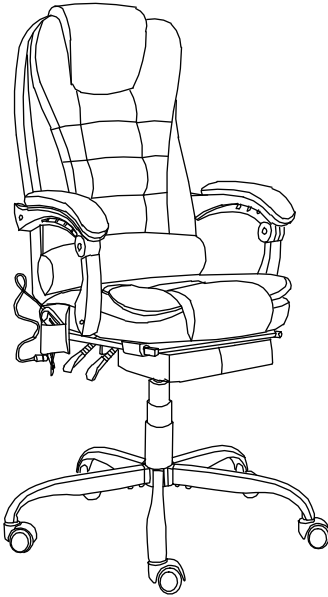

Remote Control Instruction

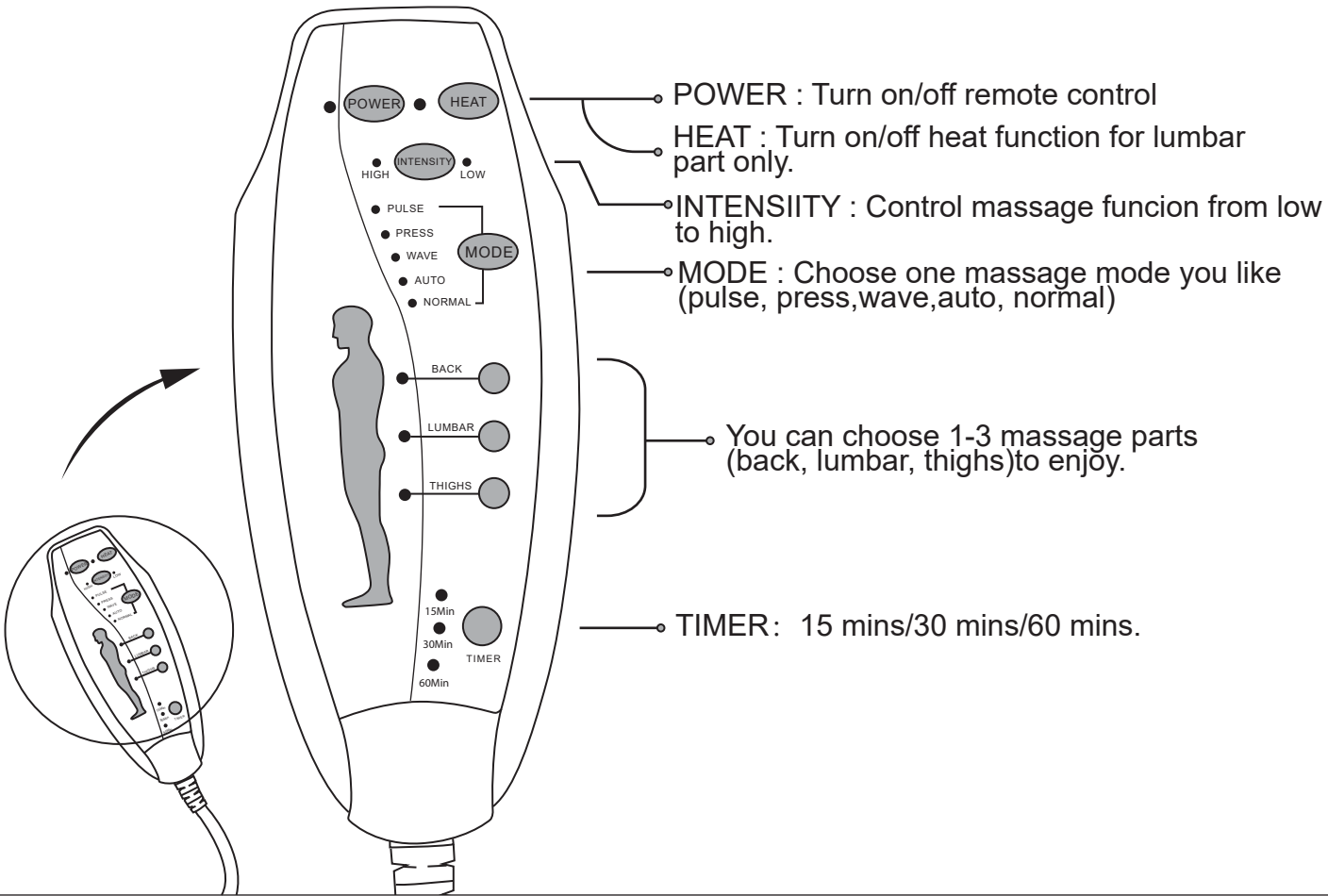











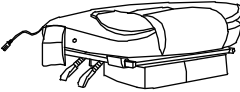

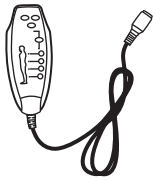
Attention

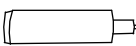
If there is any damage, please send us clear photos of the damaged parts as attachments.

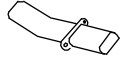
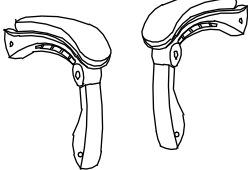
We will check and offer you the best solution soon.

If there are any missing items or other issues, please feel free to contact our customer service team for assistance.

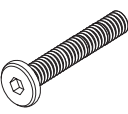
Parts List

<p>A.</p>  <p style="text-align: center;">1PC</p>	<p>B.</p>  <p style="text-align: center;">1PC</p>	<p>C.</p>  <p style="text-align: center;">1PC</p>	<p>D.</p>  <p style="text-align: center;">1PC</p>
<p>E.</p>  <p style="text-align: center;">1PC</p>	<p>F.</p>  <p style="text-align: center;">1PC</p>	<p>G.</p>  <p style="text-align: center;">5PCS</p>	<p>H.</p>  <p style="text-align: center;">1PC</p>
<p>I.</p>  <p style="text-align: center;">2PCS</p>	<p>J.</p>  <p style="text-align: center;">1PC</p>	<p>K.</p>  <p style="text-align: center;">5PCS</p>	<p>L.</p>  <p style="text-align: center;">M6*12 12PCS</p>
<p>M.</p>  <p style="text-align: center;">M8*40 4PCS</p>	<p>N.</p>  <p style="text-align: center;">4PCS</p>	<p>O.</p>  <p style="text-align: center;">1PC</p>	

STEP1

Use 10 screws (L) to connect K and J.

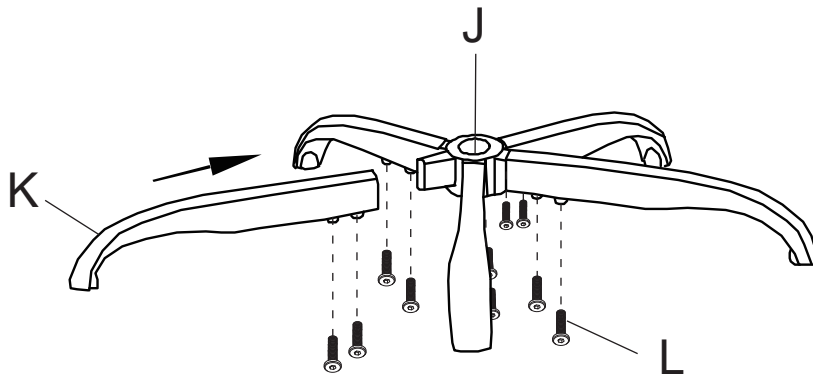

STEP2

Install 5 PCS G to K, and install E, F to K.

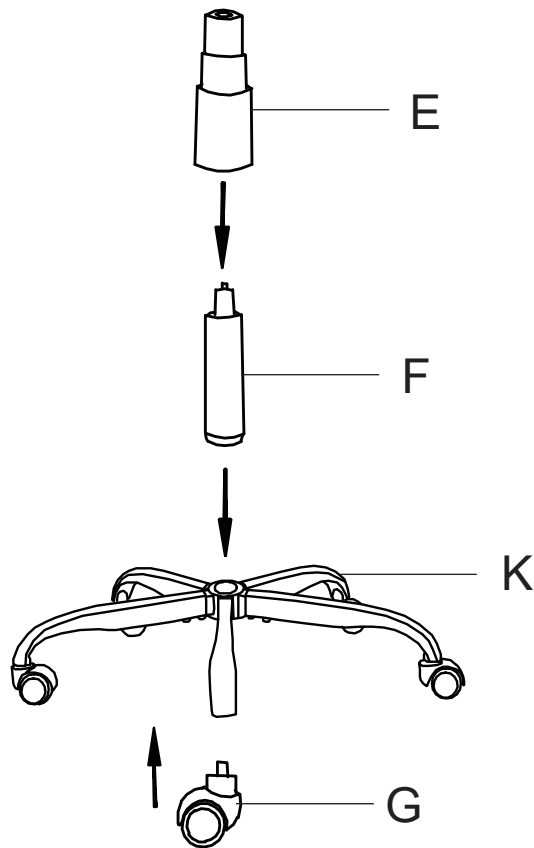

STEP3

Use 2 screws L to connect A and B through connecting rod H.

* NOTE : Two same color wires connect.

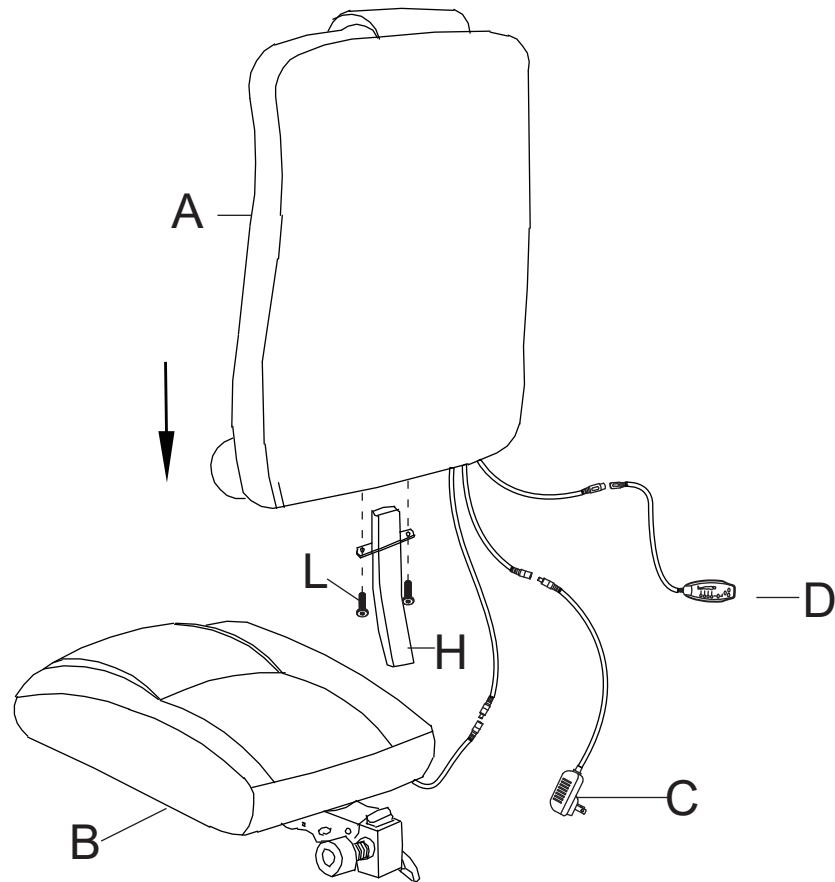

STEP4

Use MX4, NX4 to connect the armrest I.

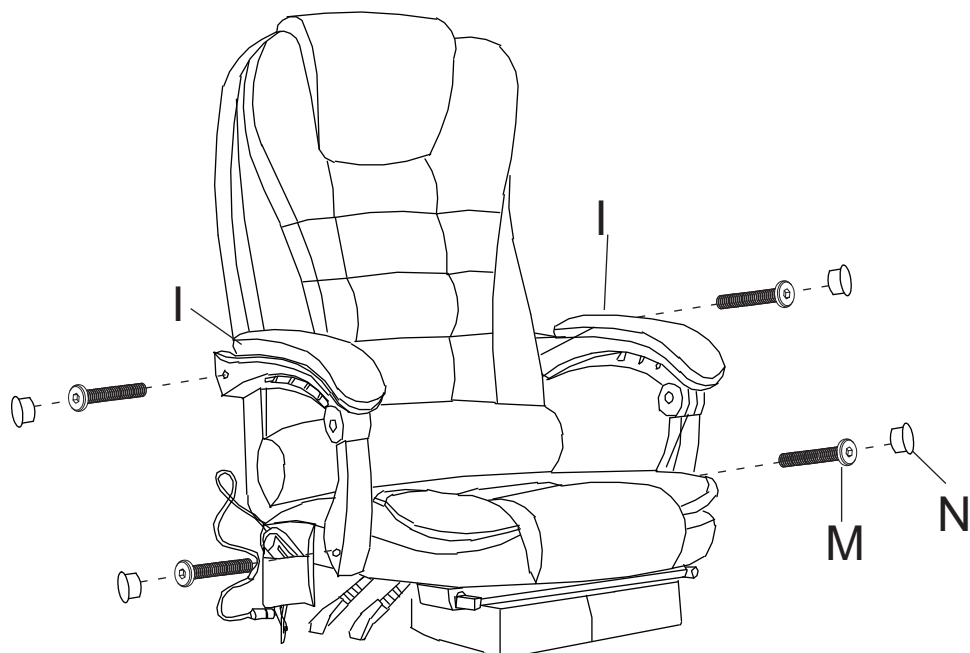

STEP5

Connect the 2 parts installed, the installation is complete.

