

ANDTE

Model:PD80K

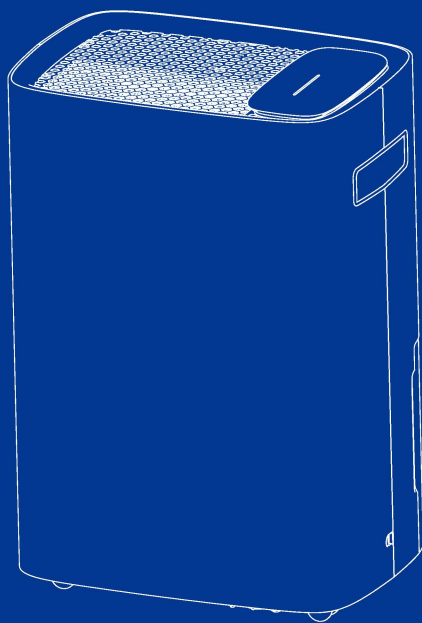

Thank you for your order.
You made our day.

Thanks for your purchase.
If any problems with our dehumidifier, please feel free to contact us

Please refer to the model on the nameplate of the machine.
Please read the user manual carefully before use and keep it properly.

Email: Support@andten.com
<https://andten.com>

Instructions for Use:

1. **Dehumidification Capacity**-The dehumidification capacity of dehumidifier is related to the area used and the ambient temperature and humidity, and the water tank capacity is not equal to the dehumidification capacity.

2. Control Panel Flashing: Dehumidifier will turn into stand by mode and flashing when the current humidity level lower than setting level, please try to set a lower target level or wait for the current humidity level rise and higher than the setting level, it will start running again from stand by mode.

If the humidity of the dehumidifier is inconsistent with the humidity you measured, it is mainly due to the inconsistency of the measurement location or the inconsistency of the evaluation method of the hygrometer and the dehumidifier.

3. Stop when the water tank is full- Dehumidifier will automatically turn off when the tank is full and the full tank indicator will turn on and sound 10 Seconds to remind you to empty the water tank. Please empty the water tank and reinstall the water tank, unit will run previous setting. If the full indicator keep warning when the tank is empty. Please make sure that the machine is placed smoothly or contact us for technical support. Please check whether the water tank is installed and whether the induction magnet of the water tank is still there.

4. Timing Setting-The dehumidifier can be turned on and off regularly. Start the machine regularly: Press the "TIMER" button after the machine is plugged in to set when the machine will start. Timing shutdown: When the machine is plugged in, press the power-on button and then press the "TIMER" button to set when the machine will shut down.

If you encounter problems, please contact our customer service. We will serve you.

Email-1: Support@andten.com

<https://andten.com>

1. Control Panel



POWER Button

To turn the dehumidifier ON/OFF.



MODE Button

To select working mode between DEHU, DRY, CONT.



TIMER Button

To set auto ON/OFF timer in 1-24 hrs.



SPEED Button

To select fan speed between high and low.



HUMIDITY Button

To set the humidity within a range of 30%RH to 80%RH in 5% increments



LOCK Button

It is used to open and release the child lock function.



WATER FULL Indicator

Indicates the water tank is full.



Auto-defrost Indicator

Unit will collect water again after Defrost complete

Note:

Allow Standing Time Before Use: After unpacking the dehumidifier, leave it standing upright for 24 hours before plugging it in. This protects the internal components and ensures optimal performance.

Placement and Clearance: Place the dehumidifier on a flat, stable surface, ensuring at least 8 inches of clearance around the unit for proper airflow.

Don't Block the Vents: When positioning the dehumidifier, please ensure it is not placed too close to walls or other objects, as this could obstruct the air vents.

Compressor Start Delay: Compressor protection function-The machine is equipped with compressor automatic delay start protection function, and the time interval between each compressor start and stop is not less than 3 minutes.

Close Doors and Windows: To maximize performance, keep doors and windows closed during operation to prevent additional moisture from entering the space.

Heat Emission During Operation: Dehumidifiers emit heat while in use, which is a normal part of the moisture absorption process.

Avoid Direct Sunlight or Heat Sources: Do not position the unit near heat sources or in direct sunlight, as this can affect its efficiency.

Filter Maintenance for Pet Owners: If you have pets, clean the filter more frequently to prevent pet hair and dander from clogging the unit, which can reduce efficiency.

Ensure Proper Drainage Slope: When using a drainage hose, position it at a downward angle to avoid back flow and allow smooth water removal.

- Before cleaning the dehumidifier, please turn off the machine and unplug it from the power source.
- Please do not place the machine near heat or flammable goods.
- Do not put any sticks or your fingers into the air inlet or outlet.
- Please always place the machine on a flat ground, rather than uneven or slopping ones.
- Do not spray water, insecticides or flammable liquids on the machine.
- Please do not place the machine in a confined or narrow space.
- In Dry Mode, please keep the clothes at least 15.7 inches away from the air outlet to prevent the water entering the machine to cause damages.
- Please make sure the machine power wiring is installed in accordance with national wiring rules. The power cord should be connected to a reliable external naught wire.
- The specification of the fuse: 3.15A.
- Dehumidifier limit operating temperature range of 41°F-95°F(5°C-35°C), the recommended operating temperature range: 64°F-95°F (18°C-35°C), Unit working below 64 °F/18°C will frequently turn into the auto-defrost and result a poor dehumidification effect, which is normal.
- If the supply cord is damaged, it must be replaced by the manufacturer, its service agent or similarly qualified persons in order to avoid a hazard.
- This appliance is not intended for use by persons (including children) with reduced physical, sensory or mental capabilities, or lack of experience and knowledge, unless they have been given supervision or instruction concerning use of the appliance by a person responsible for their safety.
- Children should be supervised to ensure that they do not play with the appliance.
- The red casing on the process pipe needs to be replaced with a new one and put back in place when service is done.

BEFORE FIRST USE:

To prevent any internal damage, it is very important to keep refrigeration units (like this one) upright throughout their journey.

Please leave it standing upright and outside the box for **24 HOURS** before plugging it in.

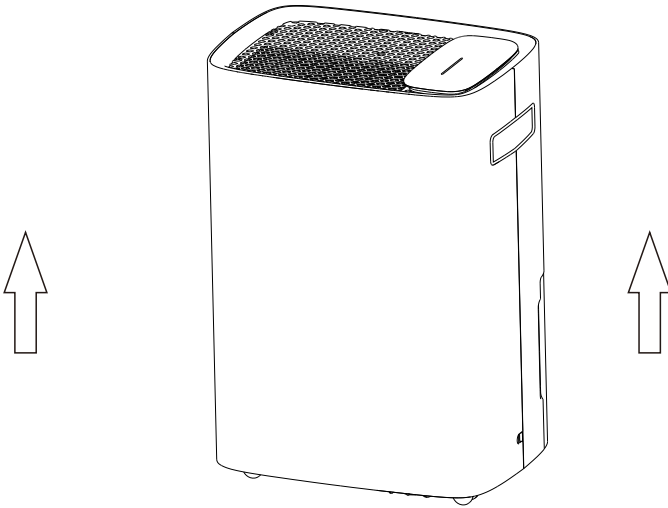

Allow Standing Time Before Use: After unpacking the dehumidifier, leave it standing upright for 24 hours before plugging it in. This protects the internal components and ensures optimal performance.

Placement and Clearance: Place the dehumidifier on a flat, stable surface, ensuring at least 8 inches of clearance around the unit for proper airflow.

Don't Block the Vents: When positioning the dehumidifier, please ensure it is not placed too close to walls or other objects, as this could obstruct the air vents.

Compressor Start Delay: To protect the compressor and extend its service life, the unit will start operating 3 minutes after being turned on.

Close Doors and Windows: To maximize performance, keep doors and windows closed during operation to prevent additional moisture from entering the space.

Heat Emission During Operation: Dehumidifiers emit heat while in use, which is a normal part of the moisture absorption process.

Avoid Direct Sunlight or Heat Sources: Do not position the unit near heat sources or in direct sunlight, as this can affect its efficiency.

Filter Maintenance for Pet Owners: If you have pets, clean the filter more frequently to prevent pet hair and dander from clogging the unit, which can reduce efficiency.

Ensure Proper Drainage Slope: When using a drainage hose, position it at a downward angle to avoid back flow and allow smooth water removal.

Automatic defrost Mode: in the winter due to the lower temperature, dehumidifier frequently into the defrost mode as a result of poor dehumidification effect, which is normal.

If the machine is not used, please store it in a dry and flat place, Avoid corrosion of machine parts by moisture.

TABLE OF CONTENTS

Warning for Using R32 Refrigerant	01
Safety Instructions	14
Parts Identification	15
Operation Instructions.....	16
Cleaning and Maintenance	26
Common Faults and Solutions	27
Safety Note	29
Service	30

Statement

The graphics and functions provided in this manual may not be the same as the actual product. Please always refer to the actual product.

The model of the machine on the manual is for reference only. Please check the corresponding content and operate the machine based on the actual product.

The right to interpret the relevant terms belongs to the company.

01 WARNING FOR R32

■ **WARNING for Using R32 Refrigerant**

Transportation, marking and storage for units that employ flammable refrigerants

1.General

The following information is provided for units that employ FLAMMABLE REFRIGERANTS.

2.Transport of equipment containing flammable refrigerants

Attention is drawn to the fact that additional transportation regulations may exist with respect to equipment containing flammable gas. The maximum number of pieces of equipment or the configuration of the equipment permitted to be transported together will be determined by the applicable transport regulations.

3.Marking of equipment using signs

Signs for similar appliances used in a work area are generally addressed by local regulations and give the minimum requirements for the provision of safety and/or health signs for a work location.

All required signs are to be maintained and employers should ensure that employees receive suitable and sufficient instruction and training on the meaning of appropriate safety signs and the actions that need to be taken in connection with these signs.

The effectiveness of signs should not be diminished by too many signs being placed together.

Any pictograms used should be as simple as possible and contain only essential details.

4.Disposal of equipment using flammable refrigerants

Refer to national regulations.

5.Storage of equipment/appliances

The storage of the appliance should be in accordance with the applicable regulations or instructions, whichever is more stringent.

6.Storage of packed (unsold) equipment

Storage package protection should be constructed in such a way that mechanical damage to the equipment inside the package will not cause a leak of the REFRIGERANT CHARGE.

The maximum number of pieces of equipment permitted to be stored together will be determined by local regulations.

Requirements for operation, service and installation manuals of appliances using flammable refrigerants

Warning

Do not use means to accelerate the defrosting process or to clean, other than those recommended by the manufacturer.

The appliance shall be stored in a room without continuously operating ignition sources for example:

open flames, an operating gas appliance or an operating electric heater.

Do not pierce or burn.

Be aware that refrigerants may not contain an odour.



Appliance filled with flammable mag as R32.

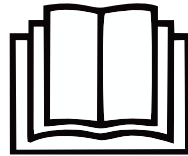

Before use the appliance, read the owner's manual first.

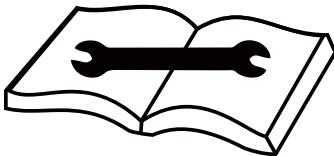

Before repair the appliance, read the service manual first.

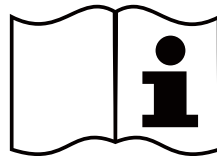

Before install the appliance, read the installation manual first.

Qualification of workers

The manual shall contain specific information about the required qualification of the working personnel for maintenance, service and repair operations. Every working procedure that affects safety means shall only be carried out by competent persons. Examples for such working procedures are:

- breaking into the refrigerating circuit;
- opening of sealed components;
- opening of ventilated enclosures.

Competence of service personnel

1.General

Information of procedures additional to usual information for refrigerating appliance installation, repair, maintenance and decommission procedures is required when an appliance with FLAMMABLE REFRIGERANT is affected.

The training of these procedures is carried out by national training organisations or manufacturers that are accredited to teach the relevant national competency standards that may be set in legislation.

The achieved competence should be documented by a certificate.

2.Information and training

2.1)The training should include the substance of the following:

2.2)Information about the explosion potential of FLAMMABLE REFRIGERANTS to show that flammables may be dangerous when handled without care.

2.3)Information about POTENTIAL IGNITION SOURCES, especially those that are not obvious, such as lighters, light switches, vacuum cleaners, electric heaters.

2.4) Information about the different safety concepts:

Unventilated-Safety of the appliance does not depend on ventilation of the housing. Switching off the appliance or opening of the housing has no significant effect on the safety. Nevertheless, it is possible that leaking refrigerant may accumulate inside the enclosure and flammable atmosphere will be released when the enclosure is opened.

Ventilated enclosure-Safety of the appliance depends on ventilation of the housing. Switching off the appliance or opening of the enclosure has a significant effect on the safety. Care should be taken to ensure sufficient ventilation before.

Ventilated room -Safety of the appliance depends on the ventilation of the room. Switching off the appliance or opening of the housing has no significant effect on the safety. The ventilation of the room shall not be switched off during repair procedures.

2.5) Information about refrigerant detectors:

- Principle of function, including influences on the operation.
- Procedures, how to repair, check or replace a refrigerant detector or parts of it in a safe way.
- Procedures, how to disable a refrigerant detector in case of repair work on the refrigerant carrying parts.

2.6) Information about the concept of sealed components and sealed enclosures according to IEC60079-15:2010.

2.7) Information about the correct working procedures:

a) Commissioning

- Ensure that the floor area is sufficient for the REFRIGERANT CHARGE or that the ventilation duct is assembled in a correct manner.
- Connect the pipes and carry out a leak test before charging with refrigerant.
- Check safety equipment before putting into service.

b) Maintenance

- Portable equipment shall be repaired outside or in a workshop specially equipped for servicing units with FLAMMABLE REFRIGERANTS.
- Ensure sufficient ventilation at the repair place.
- Be aware that malfunction of the equipment may be caused by refrigerant loss and a refrigerant leak is possible.
- Discharge capacitors in a way that won't cause any spark. The standard procedure to short circuit the capacitor terminals usually creates sparks.
- Reassemble sealed enclosures accurately. If seals are worn, replace them.
- Check safety equipment before putting into service.

c) Repair

- Portable equipment shall be repaired outside or in a workshop specially equipped for servicing units with FLAMMABLE REFRIGERANTS.
- Ensure sufficient ventilation at the repair place.
- Be aware that malfunction of the equipment may be caused by refrigerant loss and a refrigerant leak is possible.
- Discharge capacitors in a way that won't cause any spark.
- When brazing is required, the following procedures shall be carried out in the following order:
 - Safely remove the refrigerant following local and national regulations. If the recovery is not required by national regulations, drain the refrigerant to the outside. Take care that the drained refrigerant will not cause any danger. In doubt, one person should guard the outlet. Take special care that drained refrigerant will not float back into the building;
 - Purge the refrigerant circuit with oxygen free nitrogen;
 - Evacuate the refrigerant circuit;
 - Purge the refrigerant circuit with nitrogen for 5 min (not required for A2L refrigerants).

- Evacuate again (not required for A2L refrigerants).
- Remove parts to be replaced by cutting or brazing.
- Purge the braze point with nitrogen during the brazing procedure required for repair.
- Carry out a leak test before charging with refrigerant.
- Reassemble sealed enclosures accurately. If seals are worn, replace them.
- Check safety equipment before putting into service.

d) Decommissioning

- If the safety is affected when the equipment is putted out of service, the REFRIGERANT CHARGE shall be removed before decommissioning.
- Ensure sufficient ventilation at the equipment location.
- Be aware that malfunction of the equipment may be caused by refrigerant loss and a refrigerant leak is possible.
- Discharge capacitors in a way that won't cause any spark.
- Remove the refrigerant. If the recovery is not required by national regulations, drain the refrigerant to the outside. Take care that the drained refrigerant will not cause any danger. In doubt, one person should guard the outlet. Take special care that drained refrigerant will not float back into the building.
- When FLAMMABLE REFRIGERANTS except A2L REFRIGERANTS are used.
 - Evacuate the refrigerant circuit.
 - Purge the refrigerant circuit with nitrogen for 5 min.
 - Evacuate again.
 - Fill with nitrogen up to atmospheric pressure.
 - Put a label on the equipment that the refrigerant is removed.

e) Disposal

- Ensure sufficient ventilation at the working place.
- Remove the refrigerant. If the recovery is not required by national regulations, drain the refrigerant to the outside. Take care that the drained refrigerant will not cause any danger. In doubt, one person should guard the outlet. Take special care that drained refrigerant will not float back into the building.
- When flammable refrigerants are used,
 - evacuate the refrigerant circuit.
 - purge the refrigerant circuit with oxygen free nitrogen.
 - evacuate again. (not required for A2L refrigerants); and
 - cut out the compressor and drain the oil.

Information on servicing

1.General

The manual shall contain specific information for service personnel according.

2.Checks to the area

Prior to beginning work on systems containing FLAMMABLE REFRIGERANTS, safety checks are necessary to ensure that the risk of ignition is minimised. For repair to the REFRIGERATING SYSTEM.

3.Work procedure

Work shall be undertaken under a controlled procedure so as to minimise the risk of a flammable gas or vapour being present while the work is being performed.

4.General work area

All maintenance staff and others working in the local area shall be instructed on the nature of work being carried out. Work in confined spaces shall be avoided.

5. Checking for presence of refrigerant

The area shall be checked with an appropriate refrigerant detector prior to and during work, to ensure the technician is aware of potentially toxic or flammable atmospheres. Ensure that the leak detection equipment being used is suitable for use with all applicable refrigerants, i. e. non-sparking, adequately sealed or intrinsically safe.

6. Presence of fire extinguisher

If any hot work is to be conducted on the refrigerating equipment or any associated parts, appropriate fire extinguishing equipment shall be available to hand. Have a dry powder or CO₂ fire extinguisher adjacent to the charging area.

7. No ignition sources

No person carrying out work in relation to a REFRIGERATING SYSTEM which involves exposing any pipe work shall use any sources of ignition in such a manner that it may lead to the risk of fire or explosion. All possible ignition sources, including cigarette smoking, should be kept sufficiently far away from the site of installation, repairing, removing and disposal, during which refrigerant can possibly be released to the surrounding space. Prior to work taking place, the area around the equipment is to be surveyed to make sure that there are no flammable hazards or ignition risks. "No Smoking" signs shall be displayed.

8. Ventilated area

Ensure that the area is in the open or that it is adequately ventilated before breaking into the system or conducting any hot work. A degree of ventilation shall continue during the period that the work is carried out. The ventilation should safely disperse any released refrigerant and preferably expel it externally into the atmosphere.

9. Checks to the refrigerating equipment

Where electrical components are being changed, they shall be fit for the purpose and to the correct specification. At all times the manufacturer's maintenance and service guidelines shall be followed. If in doubt, consult the manufacturer's technical department for assistance.

The following checks shall be applied to installations using FLAMMABLE REFRIGERANTS:

- the actual REFRIGERANT CHARGE is in accordance with the room size within which the refrigerant containing parts are installed;
- the ventilation machinery and outlets are operating adequately and are not obstructed;
- if an indirect refrigerating circuit is being used, the secondary circuit shall be checked for the presence of refrigerant;
- marking to the equipment continues to be visible and legible. Markings and signs that are illegible shall be corrected;
- refrigerating pipe or components are installed in a position where they are unlikely to be exposed to any substance which may corrode refrigerant containing components, unless the components are constructed of materials which are inherently resistant to being corroded or are suitably protected against being so corroded.

10.Checks to electrical devices

Repair and maintenance to electrical components shall include initial safety checks and component inspection procedures. If a fault exists that could compromise safety, then no electrical supply shall be connected to the circuit until it is satisfactorily dealt with. If the fault cannot be corrected immediately but it is necessary to continue operation, an adequate temporary solution shall be used. This shall be reported to the owner of the equipment so all parties are advised.

Initial safety checks shall include:

- that capacitors are discharged: this shall be done in a safe manner to avoid possibility of sparking;
- that no live electrical components and wiring are exposed while charging, recovering or purging the system;
- that there is continuity of earth bonding.

11.Repairs to sealed components

Sealed electrical components shall be replaced.

12.Repair to intrinsically safe components

Intrinsically safe components must be replaced.

13.Cabling

Check that cabling will not be subject to wear, corrosion, excessive pressure, vibration, sharp edges or any other adverse environmental effects. The check shall also take into account the effects of aging or continual vibration from sources such as compressors or fans.

14.Detection of flammable refrigerants

Under no circumstances shall potential sources of ignition be used in the searching for or detection of refrigerant leaks. A halide torch (or any other detector using a naked flame) shall not be used.

The following leak detection methods are deemed acceptable for all refrigerant systems.

Electronic leak detectors may be used to detect refrigerant leaks but, in the case of FLAMMABLE REFRIGERANTS, the sensitivity may not be adequate, or may need re-calibration. (Detection equipment shall be calibrated in a refrigerant-free area.) Ensure that the detector is not a potential source of ignition and is suitable for the refrigerant used. Leak detection equipment shall be set at a percentage of the LFL of the refrigerant and shall be calibrated to the refrigerant employed, and the appropriate percentage of gas(25 % maximum) is confirmed.

Leak detection fluids are also suitable for use with most refrigerants but the use of detergents containing chlorine shall be avoided as the chlorine may react with the refrigerant and corrode the copper pipe-work.

NOTE Examples of leak detection fluids are:

- bubble method.
- fluorescent method agents.

If a leak is suspected, all naked flames shall be removed/extinguished.

If a leakage of refrigerant is found which requires brazing, all of the refrigerant shall be recovered from the system, or isolated (by means of shut off valves) in a part of the system remote from the leak.

15. Removal and evacuation

When breaking into the refrigerant circuit to make repairs - or for any other purpose - conventional procedures shall be used. However, for flammable refrigerants it is important that best practice be followed, since flammability is a consideration.

The following procedure shall be adhered to:

- safely remove refrigerant following local and national regulations;
- evacuate;
- purge the circuit with inert gas (optional for A2L);
- evacuate (optional for A2L);
- continuously flush or purge with inert gas when using flame to open circuit ; and
- open the circuit.

The refrigerant charge shall be recovered into the correct recovery cylinders if venting is not allowed by local and national codes. For appliances containing flammable refrigerants, the system shall be purged with oxygen-free nitrogen to render the appliance safe for flammable refrigerants. This process might need to be repeated several times. Compressed air or oxygen shall not be used for purging refrigerant systems.

For appliances containing flammable refrigerants, refrigerant purging shall be achieved by breaking the vacuum in the system with oxygen-free nitrogen and continuing to fill until the working pressure is achieved, then venting to atmosphere, and finally pulling down to a vacuum (optional for A2L). This process shall be repeated until no refrigerant is within the system (optional for A2L). When the final oxygen-free nitrogen charge is used, the system shall be vented down to atmospheric pressure to enable work to take place.

The outlet for the vacuum pump shall not be close to any potential ignition sources, and ventilation shall be available.

16. Charging procedures

In addition to conventional charging procedures, the following requirements shall be followed.

- Ensure that contamination of different refrigerants does not occur when using charging equipment. Hoses or lines shall be as short as possible to minimise the amount of refrigerant contained in them.
- Cylinders shall be kept in an appropriate position according to the instructions.
- Ensure that the REFRIGERATING SYSTEM is earthed prior to charging the system with refrigerant.
- Label the system when charging is complete (if not already).
- Extreme care shall be taken not to overfill the REFRIGERATING SYSTEM.

Prior to recharging the system, it shall be pressure-tested with the appropriate purging gas. The system shall be leak-tested on completion of charging but prior to commissioning. A follow up leak test shall be carried out prior to leaving the site.

17.Decommissioning

Before carrying out this procedure, it is essential that the technician is completely familiar with the equipment and all its detail. It is recommended good practice that all refrigerants are recovered safely. Prior to the task being carried out, an oil and refrigerant sample shall be taken in case analysis is required prior to re-use of recovered refrigerant. It is essential that electrical power is available before the task is commenced.

- a) Become familiar with the equipment and its operation.
- b) Isolate system electrically.
- c) Before attempting the procedure, ensure that:
 - mechanical handling equipment is available, if required, for handling refrigerant cylinders;
 - all personal protective equipment is available and being used correctly;
 - the recovery process is supervised at all times by a competent person;
 - recovery equipment and cylinders conform to the appropriate standards.
- d) Pump down refrigerant system, if possible.
- e) If a vacuum is not possible, make a manifold so that refrigerant can be removed from various parts of the system.
- f) Make sure that cylinder is situated on the scales before recovery takes place.
- g) Start the recovery machine and operate in accordance with instructions.
- h) Do not overfill cylinders (no more than 80 % volume liquid charge).
- l) Do not exceed the maximum working pressure of the cylinder, even temporarily.
- j) When the cylinders have been filled correctly and the process completed, make sure that the cylinders and the equipment are removed from site promptly and all isolation valves on the equipment are closed off.
- k) Recovered refrigerant shall not be charged into another REFRIGERATING SYSTEM unless it has been cleaned and checked.

18.Labelling

Equipment shall be labelled stating that it has been de-commissioned and emptied of refrigerant. The label shall be dated and signed. For appliances containing FLAMMABLE REFRIGERANTS, ensure that there are labels on the equipment stating the equipment contains FLAMMABLE REFRIGERANT.

19.Recovery

When removing refrigerant from a system, either for servicing or decommissioning, it is recommended good practice that all refrigerants are removed safely.

When transferring refrigerant into cylinders, ensure that only appropriate refrigerant recovery cylinders are employed. Ensure that the correct number of cylinders for holding the total system charge is available. All cylinders to be used are designated for the recovered refrigerant and labelled for that refrigerant (i. e. special cylinders for the recovery of refrigerant). Cylinders shall be complete with pressure-relief valve and associated shut-off valves in good working order. Empty recovery cylinders are evacuated and, if possible, cooled before recovery occurs.

The recovery equipment shall be in good working order with a set of instructions concerning the equipment that is at hand and shall be suitable for the recovery of the flammable refrigerant. If in doubt, the manufacturer should be consulted. In addition, a set of calibrated weighing scales shall be available and in good working order. Hoses shall be complete with leak-free disconnect couplings and in good condition.

The recovered refrigerant shall be processed according to local legislation in the correct recovery cylinder, and the relevant waste transfer note arranged. Do not mix refrigerants in recovery units and especially not in cylinders.

If compressors or compressor oils are to be removed, ensure that they have been evacuated to an acceptable level to make certain that flammable refrigerant does not remain within the lubricant. The compressor body shall not be heated by an open flame or other ignition sources to accelerate this process. When oil is drained from a system, it shall be carried out safely.

02 Safety Instructions

Safety Notes:

For your safety, please read the manual carefully and keep the manual before you use the manual for reference.

Please use this product according to the instructions of installation and operation of this manual.

- Before cleaning the dehumidifier, turn off the power and unplug it from the power outlet.
- Please do not place the machine near any heat source or flammable goods.
- Do not insert your fingers or sticks into the air inlet or outlet.
- Always keep the machine on even surface, instead of placing on uneven or slopping ground.
- Do not spray water, insecticides or flammable liquids on the unit.
- This machine should not be placed in a confined and narrow space.
- When the power cord is damaged, it must be replaced by the qualified technician approved by our company.
- When using the dry clothes function, the clothes should be kept at least 40cm away from the air to prevent water from entering the outlet and damage the machine.
- The machine power wiring must be in accordance with national wiring rules, and, power line should be connected to the reliable external Earth Line.
- The fixed wiring of the machine connection must be equipped with an all-pole disconnect device (air switch) with at least 0.118-inch distance of electric shock.
- Model specification of safety tube:3.15A.
- This appliance can not be used by children aged under 8 years old and persons with reduced physical, sensory or mental capabilities or lack of experience and knowledge unless they have been given supervision or instructions concerning use of the appliance in a safe way and understand the hazards involved. Children shall not play with the appliance. Cleaning and user maintenance shall not be made by children without supervision.
- When using dehumidifier, other objects surrounding the machine need to be kept at least a distance of 7.9 inches (20cm) as shown in the picture on the right:

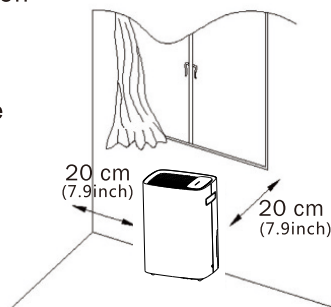

Parts Identification

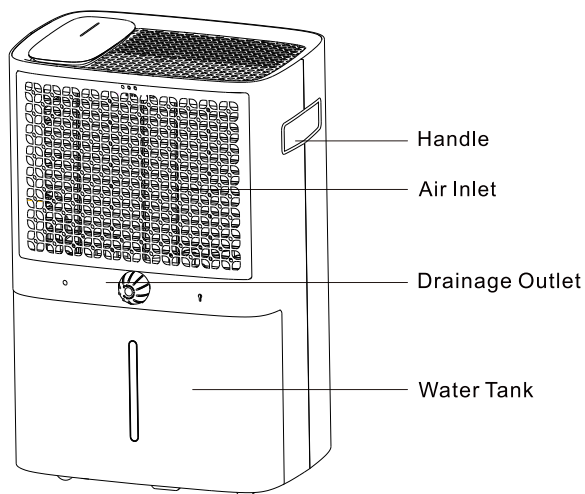
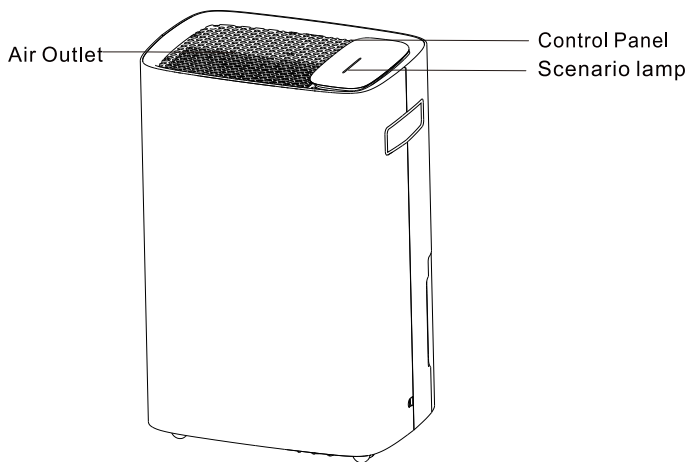

Operation Instructions

1. Control Panel



POWER Button

To turn the dehumidifier ON/OFF.



MODE Button

To select working mode between DEHU, DRY, CONT.



TIMER Button

To set auto ON/OFF timer in 1-24 hrs.



SPEED Button

To select fan speed between high and low.



HUMIDITY Button

To set the humidity within a range of 30%RH to 80%RH in 5% increments



LOCK Button

It is used to open and release the child lock function.



WATER FULL Indicator

Indicates the water tank is full.



Auto-defrost Indicator

Unit will collect water again after Defrost complete

Note:

Allow Standing Time Before Use: After unpacking the dehumidifier, leave it standing upright for 24 hours before plugging it in. This protects the internal components and ensures optimal performance.

Placement and Clearance: Place the dehumidifier on a flat, stable surface, ensuring at least 8 inches of clearance around the unit for proper airflow.

Don't Block the Vents: When positioning the dehumidifier, please ensure it is not placed too close to walls or other objects, as this could obstruct the air vents.

Compressor Start Delay: Compressor protection function-The machine is equipped with compressor automatic delay start protection function, and the time interval between each compressor start and stop is not less than 3 minutes.

Close Doors and Windows: To maximize performance, keep doors and windows closed during operation to prevent additional moisture from entering the space.

Heat Emission During Operation: Dehumidifiers emit heat while in use, which is a normal part of the moisture absorption process.

Avoid Direct Sunlight or Heat Sources: Do not position the unit near heat sources or in direct sunlight, as this can affect its efficiency.

Filter Maintenance for Pet Owners: If you have pets, clean the filter more frequently to prevent pet hair and dander from clogging the unit, which can reduce efficiency.

Ensure Proper Drainage Slope: When using a drainage hose, position it at a downward angle to avoid back flow and allow smooth water removal.



2.Mode

Setting Humidity

The humidity level can be set within a range of 30%RH to 80%RH in 5% increments.

- -When it starts to work, it will first automatically detect and show the room's humidity. Press the " HUMIDITY " button to change the humidity selection in 5% increments. " 88 " will Flash and show the setting humidity.
- -Press " HUMIDITY " button to make the humidity increase OR decrease by 5%RH.
- -After no operation for 5s, " 88 " will show the actual room humidity.
- -When the humidity level is higher or drops to the level you have set, the dehumidifier will automatically begin to work or stop.
- -When the humidity level is set at 30%RH, the dehumidifier will work at continuous dehumidifying mode.

Child Lock Setting

Press and hold the “” button for 3-5 seconds to lock or unlock the control panel. When the “” function has been activated, the indicator illuminates, and other buttons will be disabled. To regain use of the buttons, unlock the control button.

Timer Setting



This TIMER setting function is designed for you to set a time to turn off or turn on the machine, automatically by the timer.

1. Press the "TIMER" button to select the timer by 1-hour increment. You can set the timer up to 24 hours. It will start to do the countdown when you start the timer.
2. If the time is set to 00, this is called the invalid time. If you set the timer successfully, the light "TIMER" will be up. The LED screen will show the remaining time if you press the "TIMER" button, and display the current humidity automatically after a few seconds.



Speed Button

Control the fan speed. Press to select either High or Normal fan speed. Higher fan speed will result in quicker moisture removal. Set the speed high for maximum moisture removal. When the humidity has been reduced and quiet operation is more preferred, set the fan speed back to Normal.

DEHU (Dehumidify) Mode



Press the "  " button until the "  " indicator light is displayed. This is the "DEHU" mode. After selecting the "DEHU" mode, set the target HUMIDITY value with the "Humidity" button. (range 30%-80%)

DRY (Laundry Dry) Mode



Press the "  " button until you see the "  " indicator light up on the display to select DRY-CLOTHES mode. In the "  " mode, the dehumidifier will run continuously at high fan speed.

Note: In the DRY mode, the SETTING button and the SPEED button is disabled.

CONT (Continuous) Mode

Press the "  " button until you see the "  " indicator light up on the display to select continuous mode. In "  " mode, the dehumidifier will run continuously until the water tank is full.

Overflow Protection

When the water tank is full of water, the machine will turn off automatically. The indicator light "  " will flash. After you empty the water from the water tank, the indicator light "  " will turn off. The machine will restart to work.



Caution:

Water tank must be placed in right position, otherwise will cause the water full alarm.

Convenient Drainage

When the water tank is full, the "  " Tank indicator will light up. No need to check the tank from time to time.

Auto Drainage: The dehumidifier has continuous drainage outlet where you can just simply attach the 6.56 ft. hose for continuous draining.

Manual Drainage: When the water tank is "  ", the "  " indicator will light up, the dehumidifier will automatically switch off and will start to turn on automatically when the tank is emptied and placed back to the unit.

More Functions

Auto Shut-off

When the water tank is full and or the room humidity reaches the setting value, the dehumidifier will stop working automatically.

3 Minutes Delay Protection

The compressor features the "3 minutes delay protection" function— When the dehumidifier is powered, the compressor can only start again 3 minutes after its last shutdown.

Auto Defrost

When the dehumidifier is running at a lower temperature, the system will automatically determine whether there is a presence of frost. If any frost exists, it will defrost automatically.

The fan will runs at high wind speed and the compressor will stop. During the defrosting process, the " ❄️ " indicator will flash.







Auto Restart

If the dehumidifier shut off unexpectedly due to the power outage while it's running or in standby mode, the dehumidifier will restart with the previous function setting (working mode, setting humidity value and fan speed, etc.) automatically when the power resumes.

4Scene light settings

S/N	Lamp color	Applicable status
1	Light cyan	$0\% \leq \text{Ambient humidity} \leq 39\%$
2	Light green	$40\% \leq \text{Ambient humidity} \leq 60\%$
3	Light Blue	$61\% \leq \text{Ambient humidity} \leq 80\%$
4	Orange	$81\% \leq \text{Ambient humidity} \leq 100\%$

3. Display Status Description

- When the device is currently powered on, before switching on the machine for further operations .
- Setting light "  "If the timer is set up properly, the indicator light will be up, flash if press TIMER button again to check and reset, and go out if non-successful setup.
- High-speed indicator light "  ": If you set the unit to high speed fan mode, the indicator will light up.
Low-speed indicator light "  ": If you set the unit to low speed fan mode, the indicator will light up.
- Dehumidification light "  " : When the machine starts to dehumidify, the indicator light will be on.
- Water full light indicator "  " When the water tank is full, this indicator will flash.
- When the dehumidifier normally works, "  " will show the current humidity.
- Defrost indicator "  " -when the equipment enters defrosting, the indicator lights up or flashes.

4. Instructions for Drying Clothes

1.The dehumidifier can be used for drying clothes in rainy weather.

Step 1.

Hang the washed clothes in a small space such as cloakroom, bathroom, or storage room.

Note: Keep away the unit from the water drips of the washed clothes.

Step 2.

"Dry" Model- Turn on the dehumidifier and adjust the mode to " Dry" Model. It is best to let the air outlet of the dehumidifier blow air directly onto the clothes.

2. The drying effect will vary from the thickness of clothes, the number of clothes and the size of the drying space. Theoretically, the effect will be better when clothes are few, thin and space is small.

3. The drying process would take 3-8 hours, and we suggest that continuous drainage mode would be more suitable when drying clothes.

5. Faults & Processing Methods

Fault Phenomenon	Analysis of Causes	Processing Method
Humidity always shows "25%RH"(There is a big difference from the actual humidity)	Humidity sensor failure?	<p>Set the humidity to 30%RH, the dehumidifier can still continue to work, and can be used normally.</p> <p>Repair and replace the humidity sensor.</p>
Humidity always shows "99%RH"(There is a big difference from the actual humidity)	<p>1. Water on the surface of the humidity sensor?</p> <p>2. Humidity sensor failure?</p>	<p>The dehumidifier is not affected and can continue to work, and can be used normally.</p> <p>Please let the dehumidifier keep working for a period of time, after the water on the surface of humidity sensor is removed, it will return to normal.</p> <p>Repair and replace the humidity sensor.</p>

Note:

Before starting the machine, please ensure that the air outlet has been opened, otherwise the machine will overheat. Do not pull out the power cord directly to stop the machine.

6. Empty The Water Tank

Two ways are available to remove the collected water.

Use The Water Tank

When the water tank is already full, the WATER FULL indicator will light up, the dehumidifier will automatically shut down until the tank has been emptied and placed back to the unit.

Ways to Empty the Water Tank

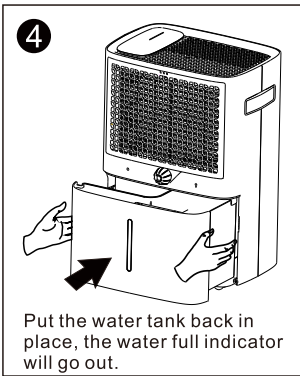
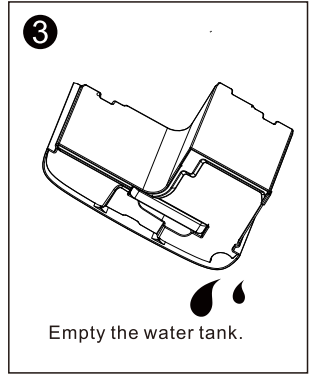
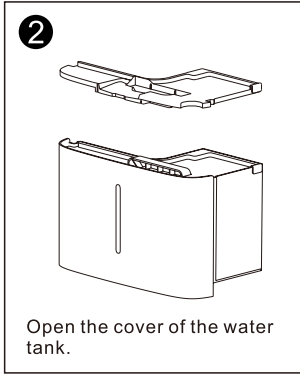
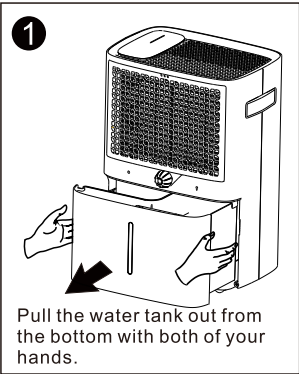

Note:

- Do not remove the float from the water tank. If the float in the water tank is removed, the sensor may not be able to determine the water level stored in the tank properly that may lead to water overflow leak from the water tank.
- If the water tank is dirty, just use cold water or warm water to clean it. Do not use detergent, steel wool, chemically treated dust cloth, gasoline, benzene, thinner or other solvents. Otherwise, it may damage the water tank and cause it to leak.
- When placing back the water tank, use your hands to press the tank back in its place. If the water tank is not placed properly, sensors or protections from water overflow may not operate as expected.

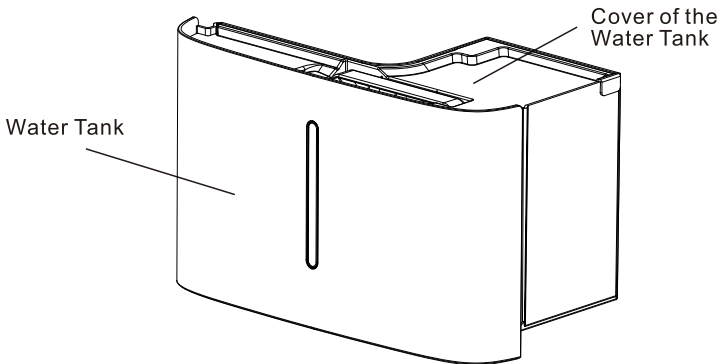

7. Continuous Drainage

Pull out the power supply, unscrew the drainage cap, remove the black rubber plug, insert the water hose into the continuous drainage port and push it back into the water tank.

Connect the power supply to start the operation. The water outlet of the water hose should be lower than the continuous drainage port by more than 3.9 inches, and the water hose cannot be bent.

(Note: The diameter of continuous drainage port is 0.63 inches.)

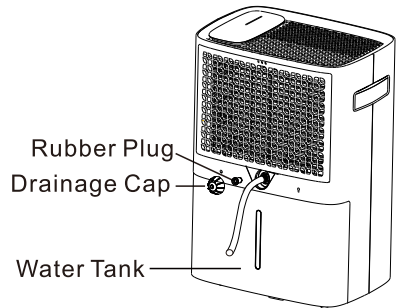
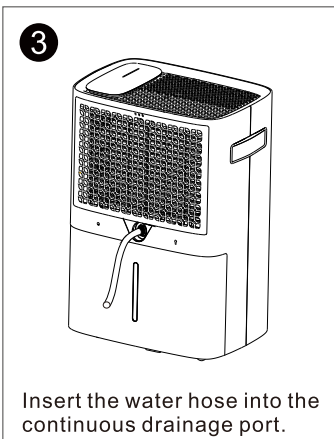
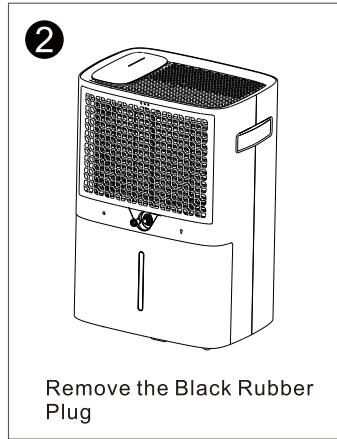
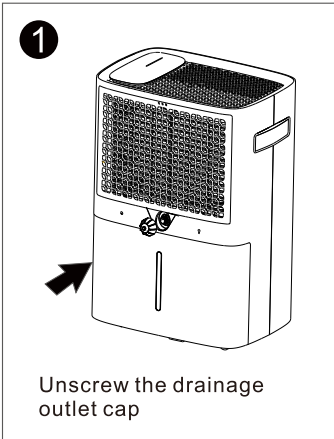

Cleaning and Maintenance

⚠ WARNING:

Turn the dehumidifier off and remove the plug from the wall outlet before Cleaning.

A- Cleaning the dehumidifier body

Please use a soft and slightly wet textile or cloth to clean it.

B- Cleaning filter

1. Pull out the filter.
2. Clean the filter: Use a vacuum cleaner to gently remove the dust from the surface of the filter. If the filter is very dirty, wipe it with warm water and a mild detergent and dry it completely.
3. Slowly insert the filter back to the machine body.

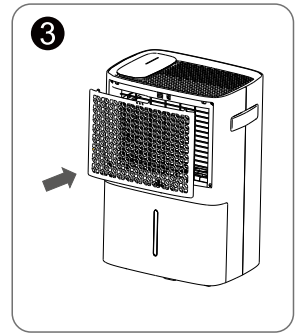
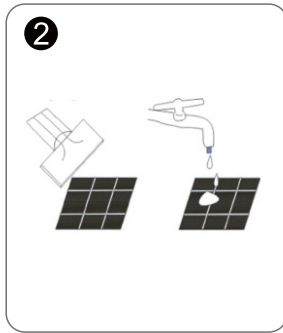
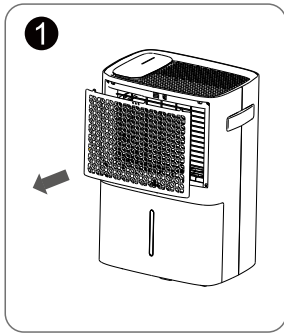

C-Dehumidifier storage

When you want to store the dehumidifier because you don't use it for a long time. Please pay attention to the following steps:

1. Empty the water in the water tank.
2. Roll up the power cord and tie it up.
3. Clean the filter.
4. Cover the dehumidifier with a storage protection bag.
5. Place the machine in a cool and dry environment.

Common Faults and Solutions

Check the information below for troubleshooting steps, it will save you time to resolve issues that may happen with the unit.

The list includes most of the common cases, but not the results of defective unit, crafts or materials in the unit.

If all troubleshooting steps have been exhausted and the issue is still occurring, please feel free to reach out to ANDTE Customer Service to get further assistance.

Email-1: Support@andten.com

<https://andten.com>

Problem	Reason	Method
Dehumidifier does not work	The power cord is unplugged.	Make sure that the unit's plug is inserted properly into the power outlet.
	Is the Full Tank indicator blinking? (The tank is full or in a wrong position.)	Empty the water in the water tank and then reposition the tank.
	Is the room temperature above 95°F (35°C) or below 41°F (5°C).	This product does not apply to over hot or cold environment, the machine will automatically enter the protection mode. It is a normal phenomenon.
	Is the room temperature between 41°F(5°C) and 68°F(20°C) ?	When running under lower ambient temperature, the machine will automatically defrost, which is a normal phenomenon. It will restart dehumidification again until the defrosting process finished.
	The dehumidifier is in the defrosting process.	It is normal the compressor ceases while defrosting process. Wait until the process finished, it will restart dehumidification again.
	Is the room humidity lower or reaching the preset humidity level? (When the room humidity has reached the preset level, the dehumidifier will enter Standby Mode and the indicator on LCD will flash.)	Please set the humidity 5%RH lower than the room humidity or set the humidity to 30%RH.
	This is to prevent the frequent start of the machine. Does the machine stop working just now?	Please wait for more than 3 minutes.
Room humidity is low.	The dehumidifier is designed to work in the humidity range of 30%-80%. Above or below this range, it will not work.	

Dehumidifier does not dry the air as it should	The air filter is dirty.	Clean the air filter.
	Is the air inlet or air outlet obstructed?	Remove the obstruction from the air inlet or outlet.
	The dehumidifier size is too small for application.	Increase the quantity of dehumidifier. Or change to a higher capacity dehumidifier.
	Poor air circulation.	Please leave about 20cm (7.9 inches) around the product.
	Do not allow enough time to remove the moisture.	Allow enough time to remove the moisture. When first installed, allow at least 3-4 days to maintain the desired RH.
	The room has not been sealed properly.	Check that all doors, windows and other openings are securely closed.
	Room temperature is too low, or below 41 °F (5°C): The machine will not work or undergo poor dehumidifying efficiency in low temperature.	Please wait until the temperature rises to above 41 °F (5°C) or higher.
The dehumidifier makes loud noise when operating	The dehumidifier is not positioned levelly.	Move the machine to a horizontal position.
	Is there blocking around the air inlet? The air filter is clogged.	Clean up the dirt or lint on the air outlet and intake.
	Is the filter installed correctly?	Please check whether the packing bag of the filter had been removed and the filter has been installed correctly.
Dehumidifier operates continuously	Check if the dehumidifier is in Continuous Mode	Do Not set the humidity too low. Typically, 40-50% are good for use.
	Room humidity is too high.	Change humidity settings. Or change to a higher capacity dehumidifier.
	Doors and windows are open.	Ensure that all doors, windows and other openings are closed.
Overflow of water on floor	Hose to connector or hose connection may be loose.	Connect the hose with the drainage port tightly.
	The water tank has not been installed properly.	Re-install the water tank properly.
	The float of water tank has been stuck.	Move the float and let it swing freely.
	The magnet on the float has come off.	Put the magnet in right position.

Safety Note



- 1** When using, please do not put the machine at the soft and uneven ground, avoid vibration and movement.



- 2** Do not insert thin rods and hard objects into the machine body to avoid malfunction and danger.



- 3** When using, please keep the machine away from heating furnace, electric kettle and other heat sources.



- 4** When using, please close doors and windows to achieve the best remove humidity effect.



- 5** Please do not put objects around the body. If the ventilation is blocked, the dehumidification effect will be affected.



- 6** If do not use the product for a long time, please unplug the power cord.



- 7** When cleaning the dehumidifier, please use the wet textile to wipe gently, do not shoot the water directly.

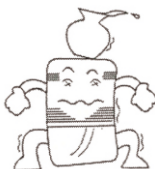

- 8** Please do not put any object on the dehumidifier.



- 9** Please clean the filter every two weeks (do not use hot water above 104°F, alcohol, gasoline or toluene.)



- 10** When continuous drainage, the drain hose must be placed horizontally, without unevenness and winding.



- 11** After cleaning the filter, please do not dry it under direct sunlight, in case deformation.



- 12** Before moving and carrying the machine, please first pour out the water in the tank.

Service

List of accessories before installation

Item	Name	Quantity
	Drain hose	1PCS

Warranty and Service

If you have an issue with an ANDTE product, please contact us at Support@andten.com, and we will do our best to resolve it for you.



Support Hours

24 Hours available

*Please have your order number before contacting customer support.

Product Certification

The product is approved to leave the factory after passing the inspection.
Production date: see the nameplate or barcode of the fuselage



ANDTE

