

Owner Manual



Ergonomic Office Chair **USER MANUAL**

Instruction

We stands for Guaranteed comfort, Aesthetic beauty, Boosted efficiency, Reliable quality, Your satisfaction, and Lasting value. Our mission is to provide you with comfortable office chairs that not only look great but also improve your work day. We know the importance of having a comfortable office chair, so we offer different kinds of chairs to suit your needs. With the professional manufacturers and our commitment to customer satisfaction, choosing is the smart choice.

Say goodbye to pains and hello to a more productive work day with chairs.

Kindly note:

The warranty period for our products is **3 years** from the date of purchase. And we only provide warranty service for products. *This office chair comes with a footrest and is recommended for two people to assemble together.*







Here are some guidelines to follow when assembling and using your product:

1. Carefully unpack the carton and check that all parts are complete according to the list.
2. If any parts are missing or damaged upon arrival, please to get required parts. Maybe the product becomes damaged due logistics or USPS.
3. If any product faults occur during the warranty period, please provide the order number or invoice to confirm the product model. We will be responsible for repairing any defective products or providing free part replacements.
4. Please use the included Allen wrench to install. Placing the chair on its carton during installation will make the process more convenient.
5. The chair is designed for use by one person at a time.
6. Use the chair only after all screws have been securely tightened.
7. Keep the Allen wrench and check that all screws are tightened every 3 months or as needed.
8. Do not stand on the chair or use it as a step ladder.
9. Please try to keep children and pets away from plastic packaging to prevent suffocation.

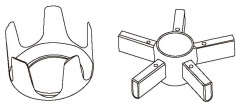
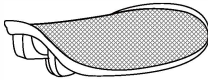
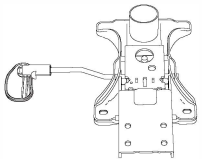
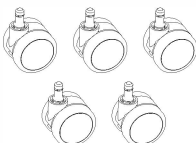
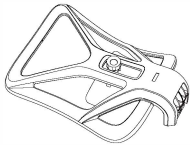

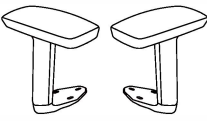
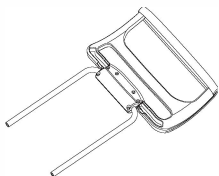
High Back Mesh Office Chair

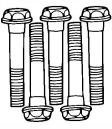
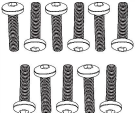
PARTS

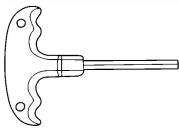
<p>(1) Headrest</p>  <p>1PC</p>	<p>(2) Star Base</p>  <p>2PC</p>	<p>(3) Mesh Seat</p>  <p>1PC</p>
<p>(4) Mechanism</p>  <p>1PC</p>	<p>(5) 5 Chair Legs</p>  <p>5PCS</p>	<p>(6) Casters</p>  <p>5PCS</p>
<p>(7) Backrest</p>  <p>1PC</p>	<p>(8) Gas Lift</p>  <p>1PC</p>	<p>(9) Armrests</p>  <p>2PCS</p>
<p>(10) Footrest</p>  <p>1PC</p>	<p>(11) Mechanism Screws: M6*12 4 pcs Leg Screws: M6*12 5pcs+1spare</p> 	<p>(12) Backrest Screws: M8*40 4pcs+1 spare</p> 
<p>(13) Arm Screws: M6*25 6 pcs Footrest Screws: M6*25 4 pcs+1 spare</p> 	<p>(14) Headrest Screws: M6*20 1pc+1 spare</p> 	<p>(15) Allen Wrench</p>  <p>1PC</p>

Step 1

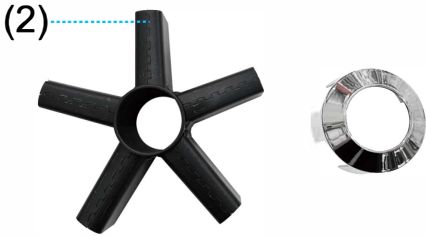

① Remove the cover of the Star Base(2) first.

② Then insert the 5 Chair Legs(5) into the Star Base(2) and fix them with the 5 Screws M6x12mm(11).

**5 chair legs are placed inside the mesh seat, please unpack the packaging, take out one leg first, then slowly take out the others.*

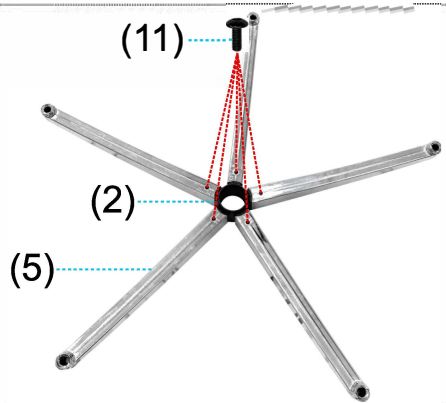

③ Finally, well-placed the decorative cover.

Step 2

Insert 5 Casters(6) to the slot of the legs, then insert the Gas Lift(8) into the center hole of the base.

★ If you feel the seat height is not quite

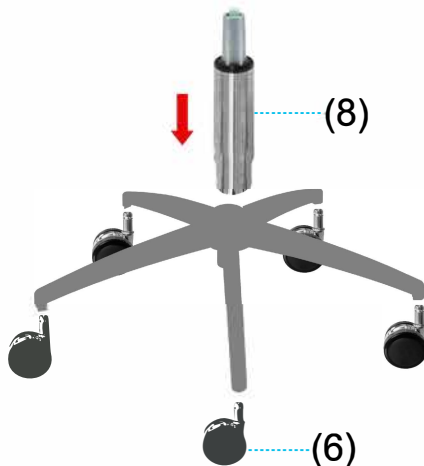

Step 3

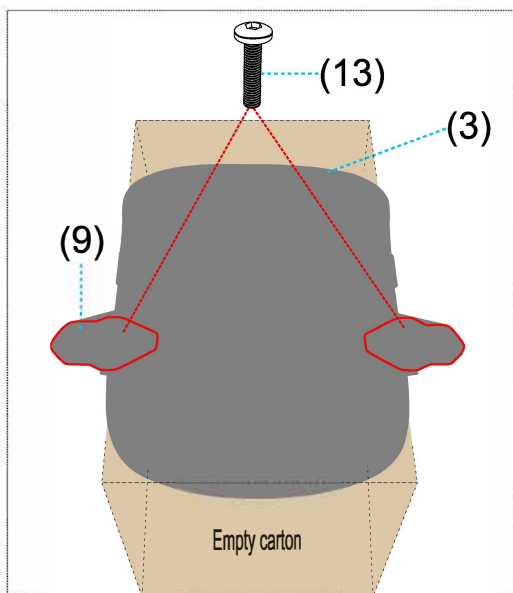

Attach the Armrests(9) to the Seat(3) with the 6 Screws M6x25mm(13).

Note:
The left and right armrests are distinguished by the mark (L/R) under the armrest pad.

★ **Seat cover** adds skin friendliness while sitting. If you want softer, please for relevant detail.



Step 4

Attach the Mechanism(4) to the Seat(3) with the 4 Screws M6x12mm(11).

Note:

If you find that the mechanism makes noise during use, please tighten all the screws first. If the noise does not decrease please to get tech support or parts replacement.

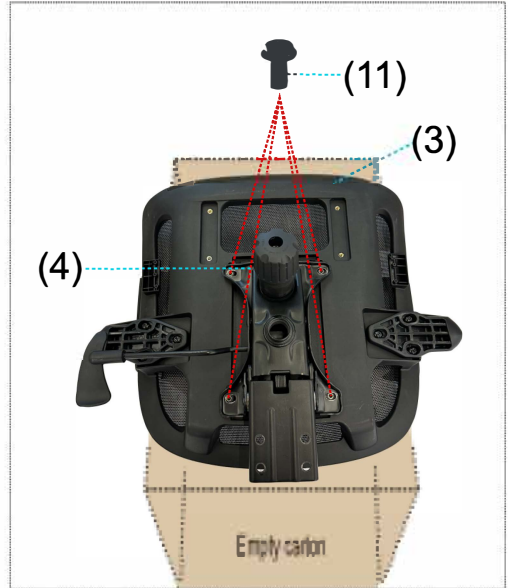

Step 5

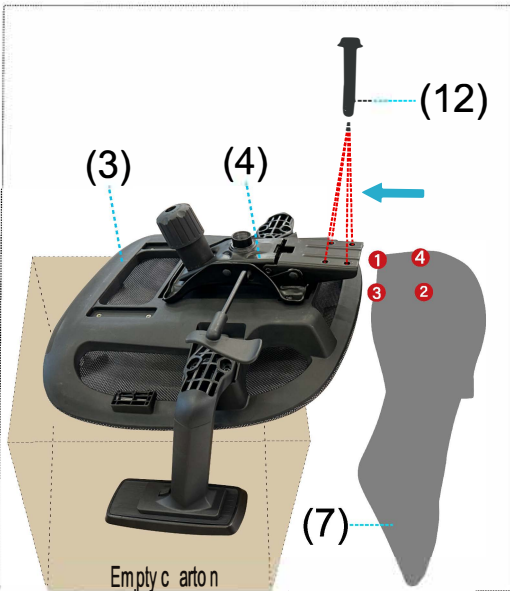

To attach the Backrest(7) to the Mechanism(4), put the back support plate **below** the Mechanism(4) and use Longer Screws M8*40mm(12) to secure it.

Tips:

To ensure that all screws are properly tightened, please screw the four screws to 70% in a diagonal fashion to secure the position in the order marked in the figure(①②③④). Then, retighten all four screws to 100%, making sure they are securely tightened.

Step 6

Take out the two connecting blocks of the Footrest(10), fix them on the corresponding position of the seat cushion with 4 Screws M6x25mm(13), and finally push the iron pipe in and fix the Footrest(10) to ensure that it will not fall out.

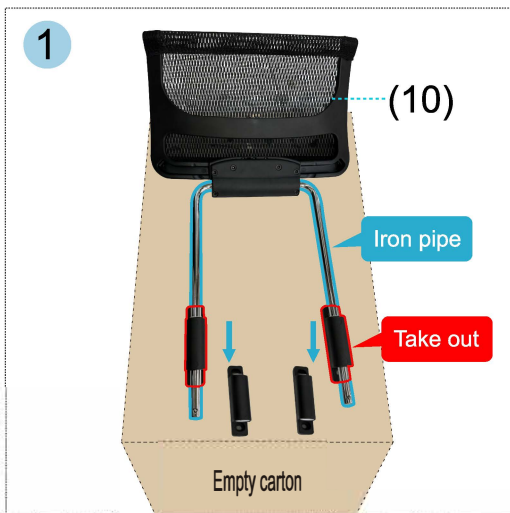

Note:

You need to press two small buttons on the iron pipe while pull/ push the two connecting blocks out/into the iron pipe.

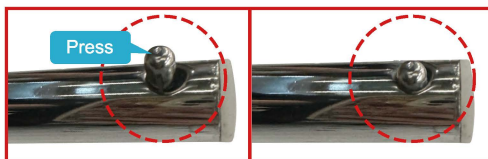

Fix them on the Seat Cushion(3), push the iron pipe in, then fix the Footrest(10). When the footrest is fully assembled, the mesh is facing down.

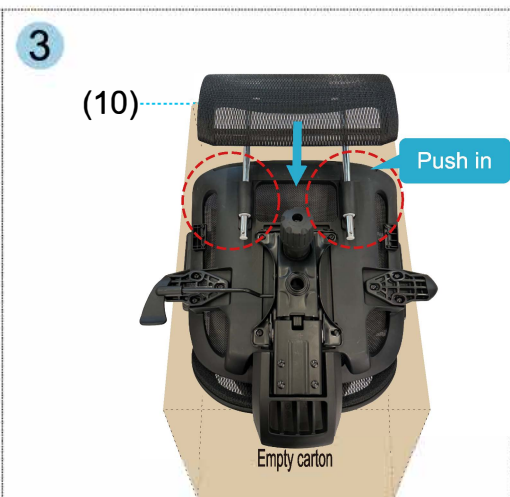
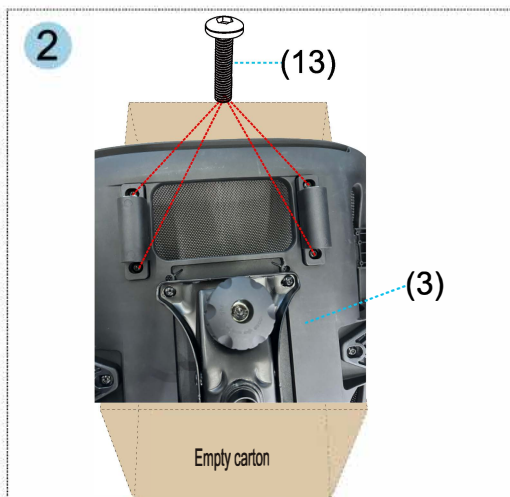

Step 7



Place the assembled chair upright with the mechanism facing downward. Insert the Gas Lift(8) into the center hole of the Mechanism(4) and press it down until it is fully engaged.

★ To fit users of different body types



Step 8

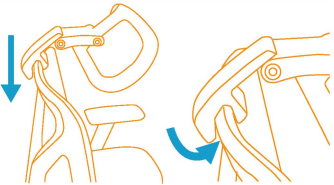

① Snap the Headrest (1) on the back frame as shown in the images.



② Please align the headrest screw hole with the backrest screw hole.

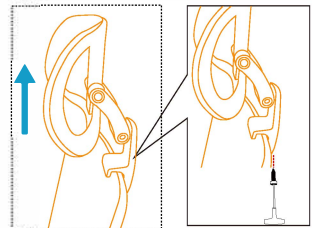

③ Secure it on the frame with the Headrest Screws (14).

Note:

Before using your chair, ensure that all the bolts are tightened fully for safety. Periodically (every 90 days) make sure that the screws are still fully tightened.

Adjust The Seat Height

Press the handle down clockwise to adjust the seat height up or down.

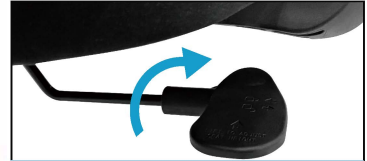

① Height Adjustment
Press the handle down clockwise

Adjust The Tilt Back Function

Free: Pull the handle out to tilt back the chair.

Lock: Push the handle in to lock the chair back in a position.

There are 3 stages to lock, allowing you to lock the chair back in 3 different positions.

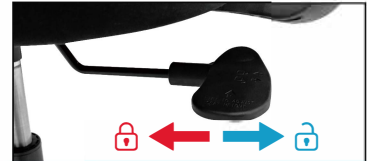

② Tilt Function
Pull out/push in the handle

Adjusting The Tilt Tension

“+”: Turn the knob clockwise to increase the resistance and strengthen the tilt resistance.

“-”: Turn the knob counter-clockwise to decrease the resistance and the chair will recline more easily and smoothly.



③ Tilt Tension
Rotate the knob

To Adjust The 3D Armrest

The armrest can adjust the height up and down, rotate in and out, and move back and forth according to daily use needs.

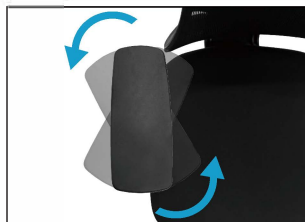

To Adjust Lumbar Support

"+": Rotate the button to clockwise, lumbar support moves forward.

"-": Rotate the button to anticlockwise, lumbar support moves back.

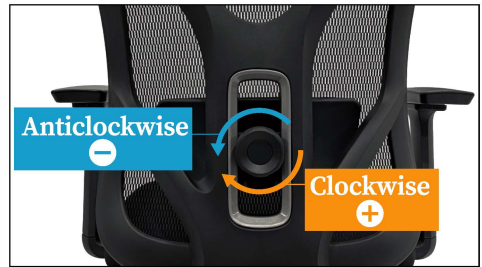

Push the button up and down to move the lumbar support freely.

To Adjust 2D Headrest

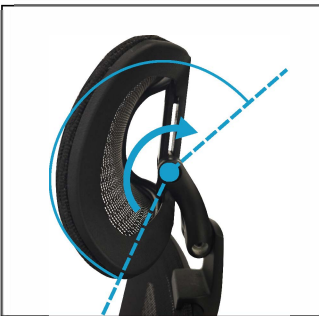

① Rotate the angle of the headrest.

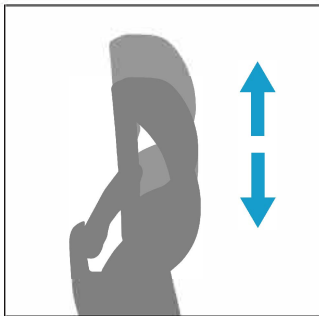

② Raise or lower the headrest.



③ If you require a higher headrest or feel that the headrest is pushing you forward, you can make further adjustments

How To Use The Footrest

(1) Lock the footrest at 2 positions

Pull out the footrest under the seat cushion, and then flip out the support surface to use. The footrest can be locked in **2** positions. One "click" is one gear lock.

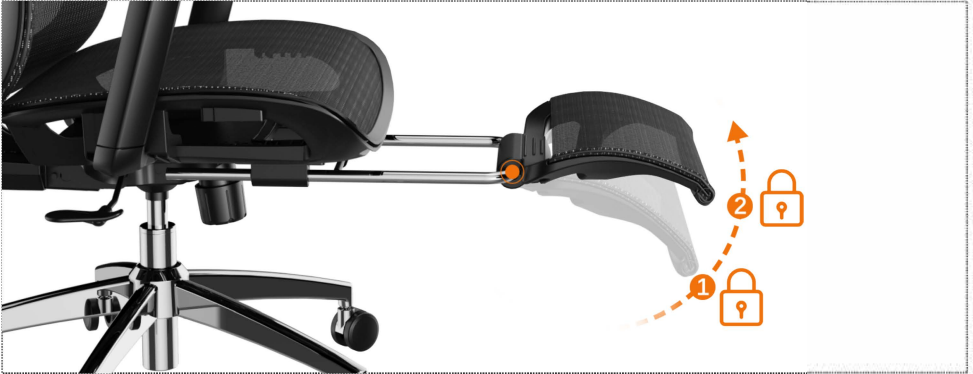

(2) Unlock & retract the footrest

- ① Flip up the footrest upwards to the highest position and reach to the UNLOCK MODE.
- ② Flip down the footrest and retract it.

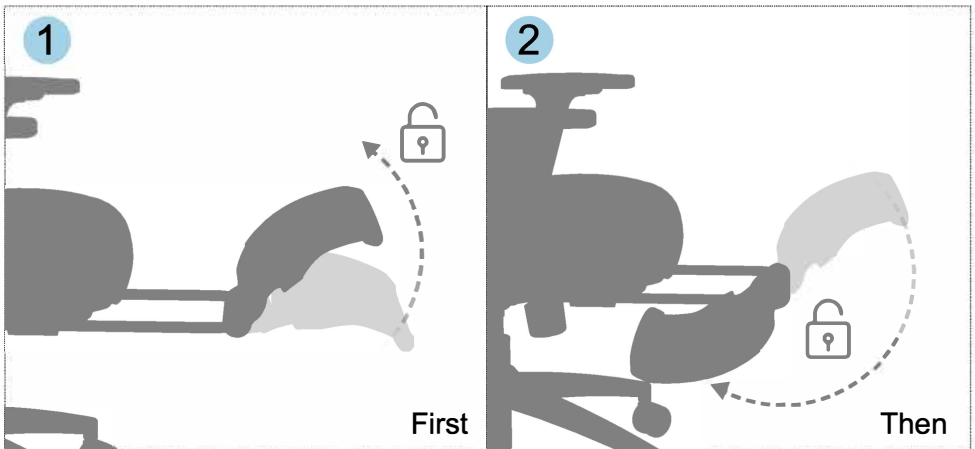

Q: Missing or damaged accessories.

A: If any accessories are missing or damaged during shipping/using, please provide the order number and pictures. We offer a 3-year warranty and will repair or replace any damaged parts.

Q: Where can I get the installation video?

A: You can find the video on the product page or search for office chair on YouTube.

Q: How do I adjust the height of the chair?

A: To raise the seat, press the handle down clockwise and lift your body slightly to allow the chair to raise to the desired height.

To lower the seat, press the handle while applying more weight downward on the seat.

Q: The height of the chair failed and dropped automatically.

A: Please provide the order number & delivery address, and we will send a new gas lift for replacement.

Q: The chair just received and cannot be adjusted the height.

A: It would be good to have a video of the operation so we can help identify the problem. Please check again if the operation is correct refer to the above 3rd Q, if it is please contact us to get a new gas lift.

Q: Chair won't restore to upright position.

A: While seated, pull the lever all the way out. Then, slightly press your back against the chair back. You should hear a "click" sound at this point, and the chair will restore to the upright position.

Q: Chair back wobbling.

A: Please check and tighten the 4 screws on the back of the chair. When all 4 screws are fully tightened, the chair should not shake significantly. If it still can't work, please provide video and order number directly for further assistance.

Q: I don't know how to use the footrest.

A: Pull out the footrest under the seat cushion, and then flip out the support surface to use. The support surface can be locked in two gears. One "click" is one gear lock. After 2 clicks, flip it up again into unlock mode.

Q: One or more of the chair legs won't tighten.

A: Please use the same screws to assemble the remaining chair legs. Usually, this just requires retightening the screws.

Q: My headrest is uncomfortable and does not provide stable head support.

A: The correct position to use the headrest is right behind the neck, which provides stable neck support. Get a comfortable position by adjusting the angle and height of the headrest.

Q: I need to return/exchange the item.

A: Please as a priority, we will provide an effective solution and save you the trouble of repacking.



Q: How to remove the seat from the gas lift?

A: Raise the chair to the highest level, then step on the base, buckle mesh seat with two hands. Shake the seat to separate the gas lift. If this does not work, you can use a soft hammer to hit the mechanism(metal plate) and then divide the gas lift from the top.

Q: How to replace/remove the gas lift?

A: ① Tip the chair onto its side. Unscrew the mechanism from the chair seat.

② Use the rubber mallet to tap the mechanism and remove the gas lift away from the mechanism.

*Another way: Use the pipe wrench to clamp tightly onto the top of the gas lift. Twist and then pull up in order to remove the gas lift.

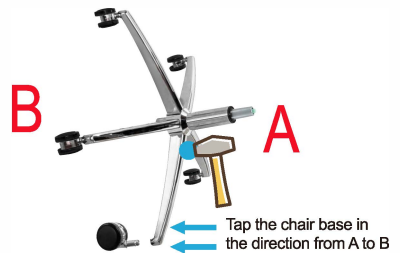

③ Use the rubber mallet to tap the chair base(tap the chair base in the direction from A to B), and allow the gas lift to move away from the base.