

MODERN 2 DOOR TV STAND

MODEL RTA-940TV

ASSEMBLY INSTRUCTIONS

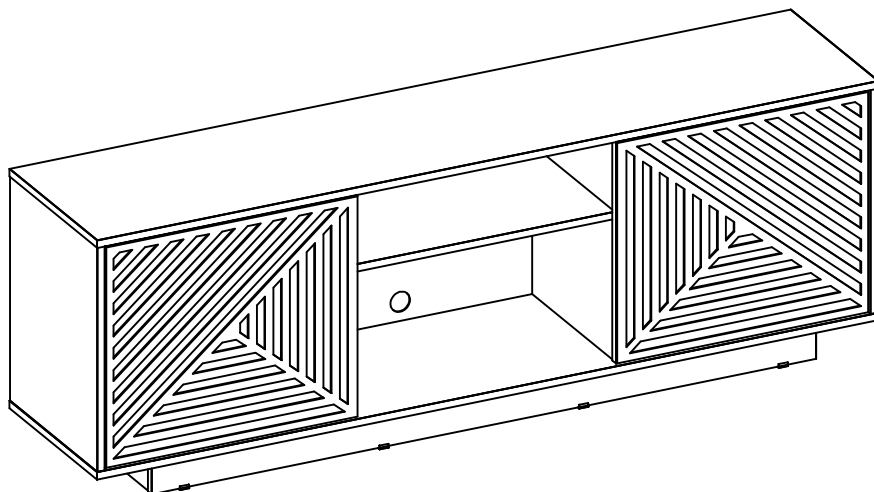

Do a quick inventory of all the parts and hardware listed below.



For Support, assembly questions & Replacement Parts within the 48 Contiguous United States:

Please email us at: support@rtaproducts.com



Replacement Parts for International Customers & **AK-HI-PR** orders: RTA Products will replace the part free of charge, while **the customer is responsible for shipping costs plus any International local taxes or duties.**

MAIN PARTS LIST

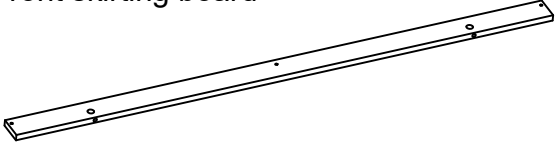
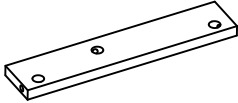
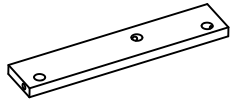
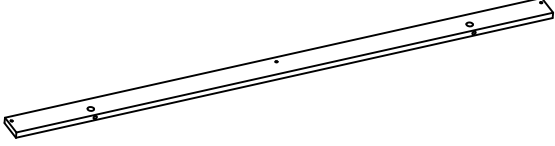
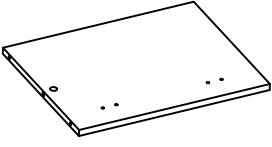
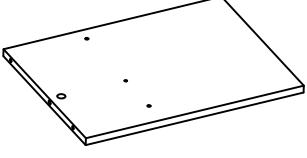
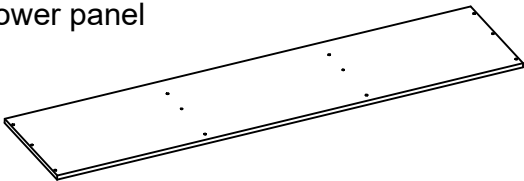
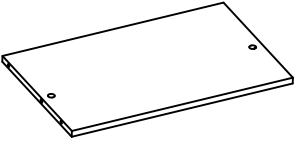
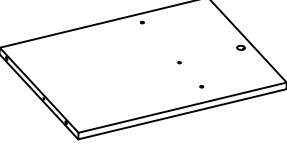
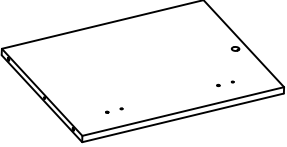
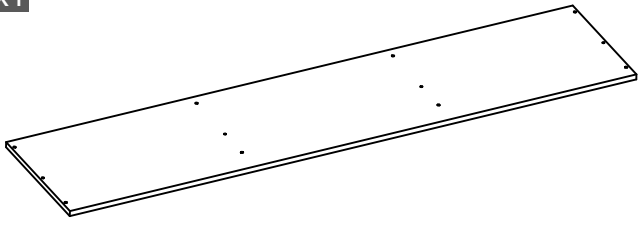
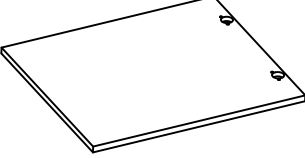
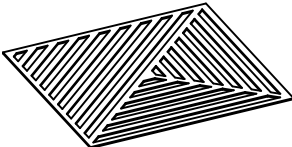
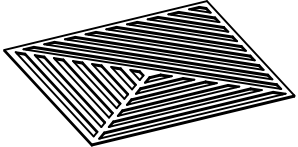
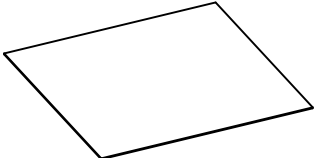
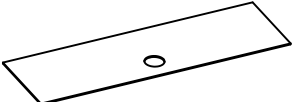
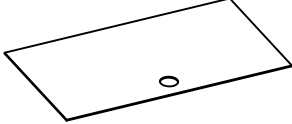
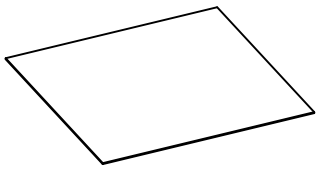
<p>1 x1 Front skirting board</p> 	<p>2 x2 Right side/central skirting board</p> 	<p>3 x1 Left side skirting board</p> 
<p>4 x1 Rear skirting board</p> 	<p>6 x1 Left side panel</p> 	<p>7 x1 Left partition panel</p> 
<p>5 x1 Lower panel</p> 	<p>8 x1 Shelf</p> 	<p>9 x1 Right partition panel</p> 
<p>10 x1 Right side panel</p> 	<p>11 x1 Main top panel</p> 	<p>12 x2 Door</p> 
<p>13 x1 Left decorative panel</p> 	<p>14 x1 Right decorative panel</p> 	<p>15 x1 Left back board</p> 
<p>16 x1 Upper back board</p> 	<p>17 x1 Lower back board</p> 	<p>18 x1 Right back board</p> 

MAIN PARTS LAYOUT (For reference)

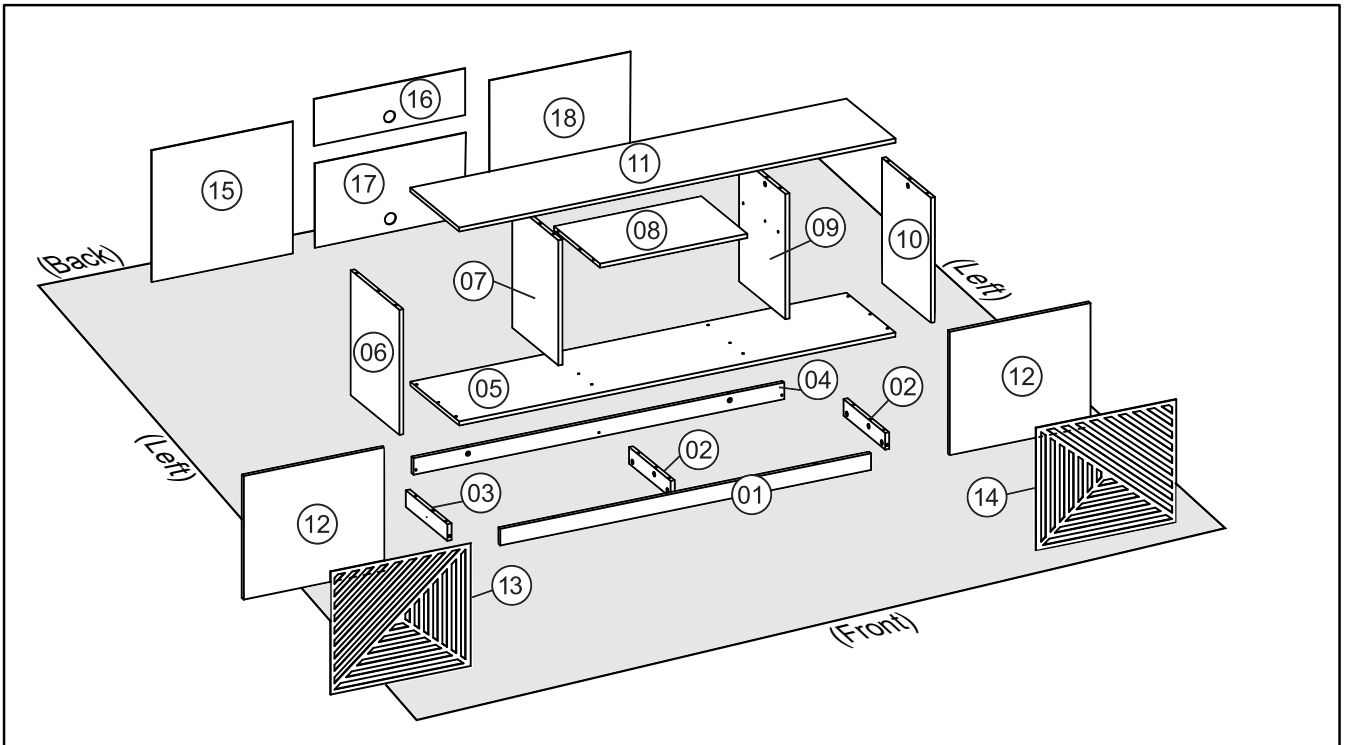

HARDWARE LIST AND INCLUDED TOOLS

PART	QTY	SIZE / DESCRIPTION	ITEM
A	4	M4x50	
B	19	M6x32 Bolt	
C	19	Cam lock	
D	26	Ø6x30 Wooden Dowel	
E	8	Plastic glide foot	
F	4	Articulated hinge	
G	4	Fixed hinge	
H	10	Square junction	
I	16	M3.5x12	
J	60	10mm nail	

PART	QTY	SIZE / DESCRIPTION	ITEM
K	40	100x10mm Double side tape	
L	2	Self-adhesive round sticker COLOR #1	
M	4	Self-adhesive round sticker COLOR #2	

TOOLS REQUIRED BUT NOT INCLUDED

Phillips Screwdriver	
Hammer	

If you decide to use a power driver:

- Make sure to have the appropriate Phillips bits.
- Start using at a low torque or speed to avoid stripping the screws.

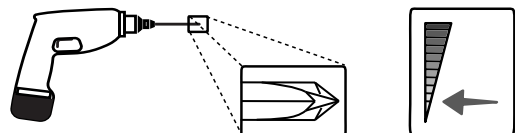

BEFORE YOU START THE ASSEMBLY, PLEASE READ THE FOLLOWING TIPS AND WARNINGS.

- Do not discard this manual or any of the packaging material until the unit is completely assembled.
- Please read the assembly instructions thoroughly and follow step by step.



- The assembly might require of 2 persons for certain steps. Before you start the installation, make sure there is someone else nearby to help you.



- Make sure you understand which hardware will be used on each step. Using the wrong size of screw, bolt or pin might strip the threads or cause damage to the part in which it is being used.

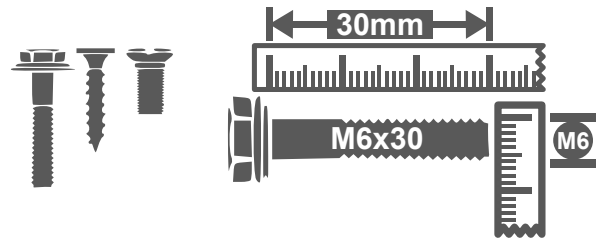

- To avoid misalignments, always leave the screws loosely and do not tighten them until all the pieces are positioned correctly.
- Do not overtighten or force the screws as they might break, strip, damage the threads of the holes, or get stuck inside the parts.

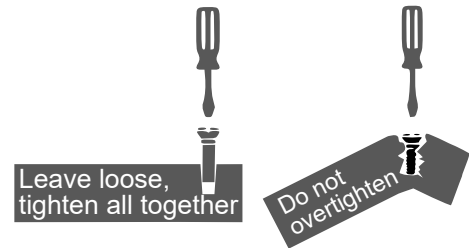

- If the hole seems to small for the screw, make sure you are using the correct size of screw and/or that you are installing it in the correct hole.



- Sometimes on the wood panels the laminate or material might be covering the hole partially or entirely, if there is no visible hole or if it looks too small, pass and press the tip of your finger over the area to feel its indentation, and carefully pierce the laminate to uncover the hole underneath.

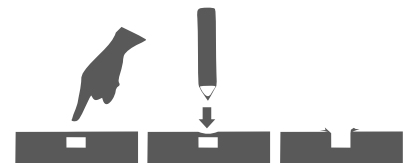

- After the item is assembled, you can use rubbing alcohol to erase or remove the visible part numbers printed or labeled on the pieces.

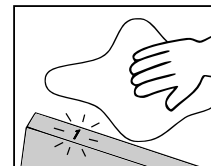

- Please be kind to our planet, when done with the assembly, recycle any of the packaging materials that is accepted by your city or recycling service.



Thank you!



THE ASSEMBLY STEPS START ON NEXT PAGE

CAM BOLT AND CAM LOCK TUTORIAL

**THE INSTRUCTIONS BELOW
ARE NOT ACTUAL ASSEMBLY STEPS**

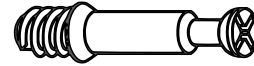

**This unit uses cam bolts and locks (also known as mini fixes).
If you are not familiar with this kind of hardware, the below is a tutorial
that explains how to use them on the steps where they are required.**

1. Screw the bolt into the indicated hole on the panel indicated in the assembly step.

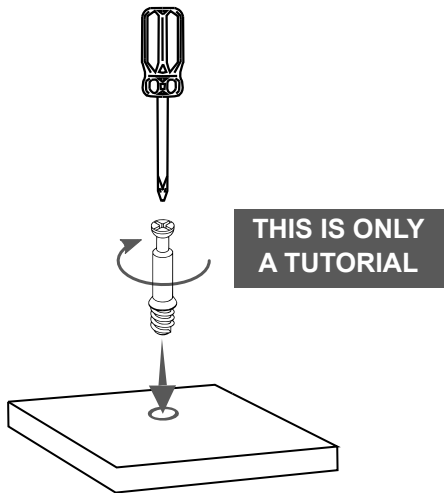

2. Join the other panel (with the big hole) to the panel with the bolt. If it comes with the cam locks already pre-installed, make sure to align them to receive the bolt's head (refer to point 3). There might be a very small gap between the panels which is normal.

If the cam locks come pre-in stalled, make sure they are aligned (see point 3).

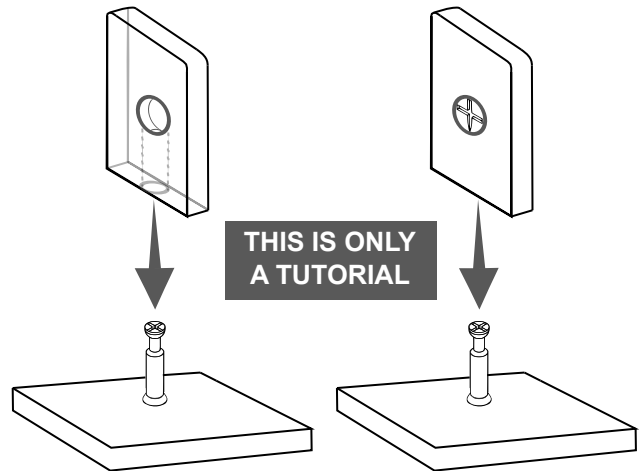

3. Insert the cam lock on the panel with the big hole making sure it goes aligned to receive the bolt's head.

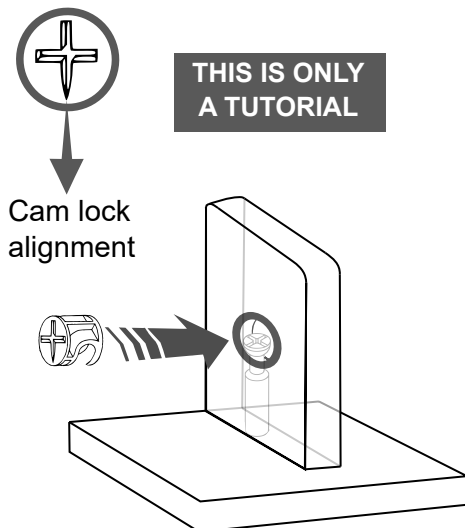

4. Use a Phillips screwdriver to turn the cam lock clockwise. This will lock the panels together and also will close any gaps.

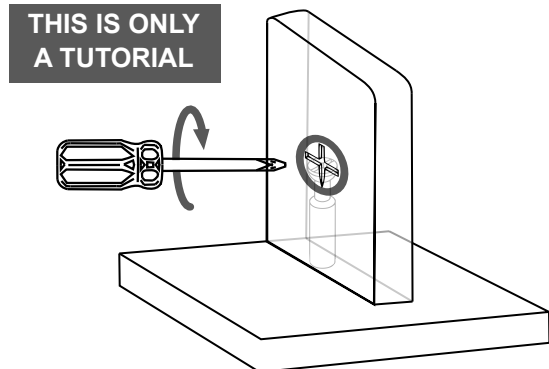

ASSEMBLY STEPS

WE RECOMMEND TO PLACE THE PIECES OVER BLANKETS TO PROTECT THEIR FINISH DURING ASSEMBLY.

STEP 1

Hardware

D		26 Pcs
	Ø6x30 Wooden dowel	

Tools (Not included)

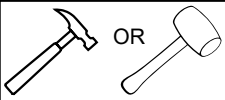

Install the wooden dowels **D** into the indicated holes on panels **2, 3, 6, 7, 8, 9** and **10**.

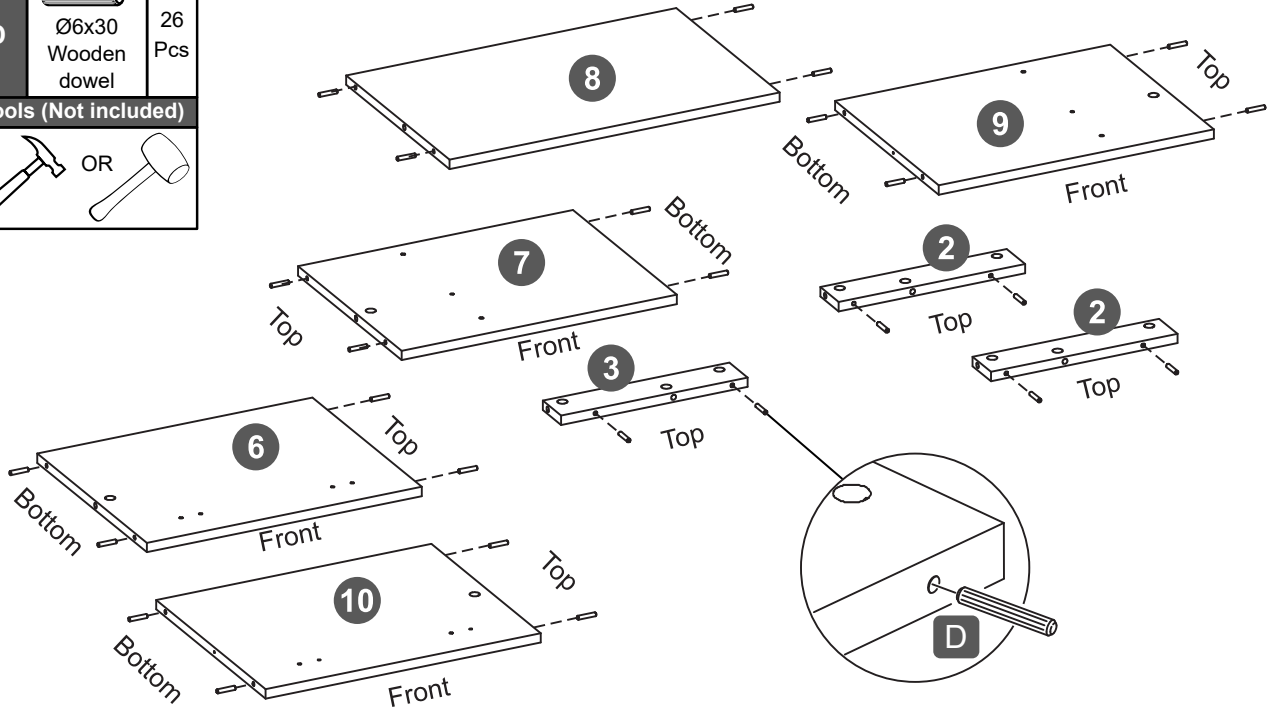

STEP 2

Hardware

B		19 Pcs
	M6x32	

Tools (Not included)

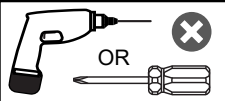

Install the bolts **B** into the indicated holes on panels **1, 4, 5, 7, 9** and **11**.

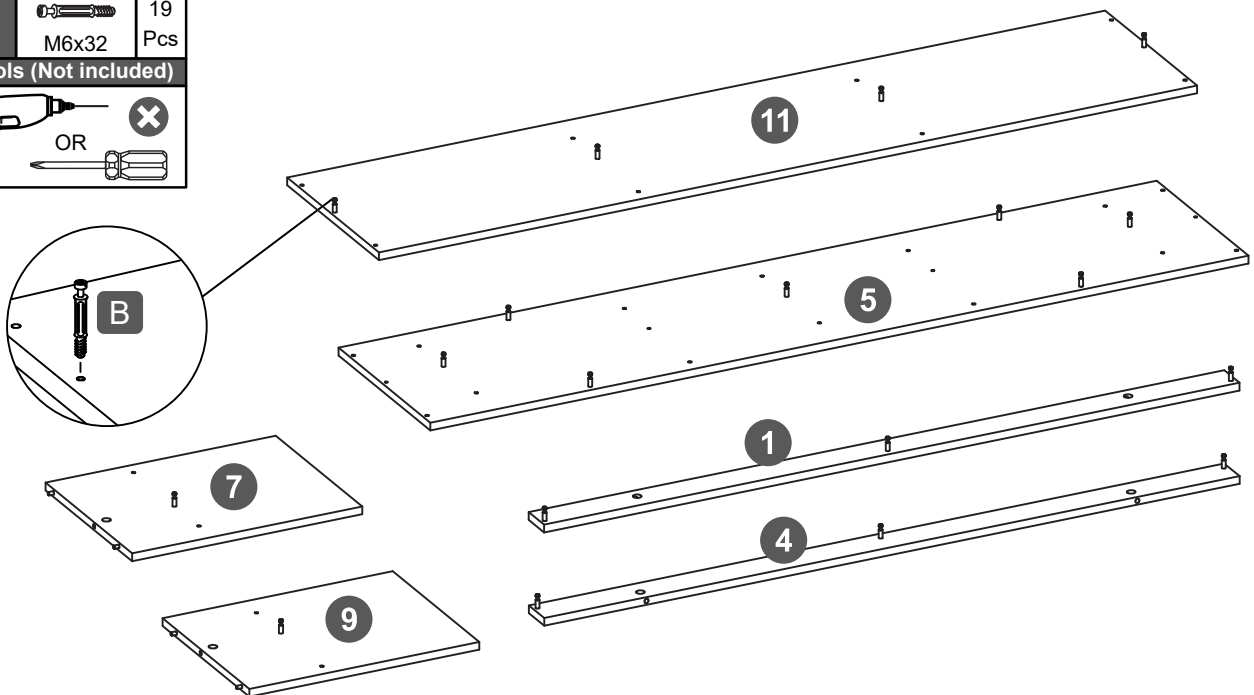

STEP 3

Hardware

C		2
	Cam lock	Pcs

Tools (Not included)

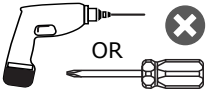

With the pieces placed oriented as shown, ensamble the partition panels **7** and **9** to the shelf **8** with cam locks **C** as explained in the **TUTORIAL PAGE**.

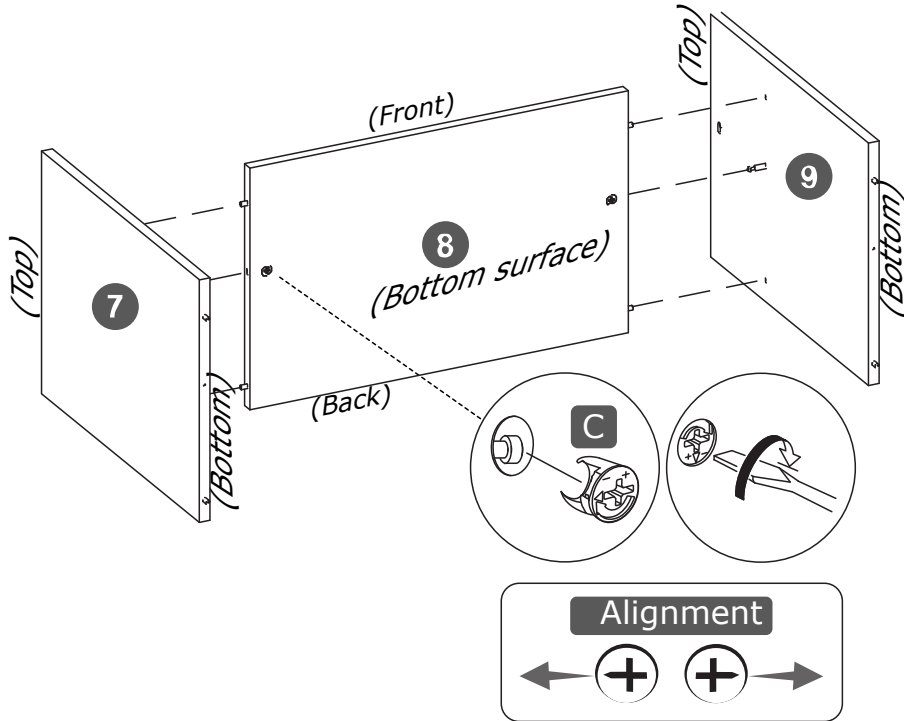

STEP 4

Hardware

C		2
	Cam lock	Pcs

Tools (Not included)

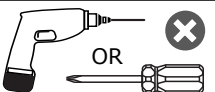



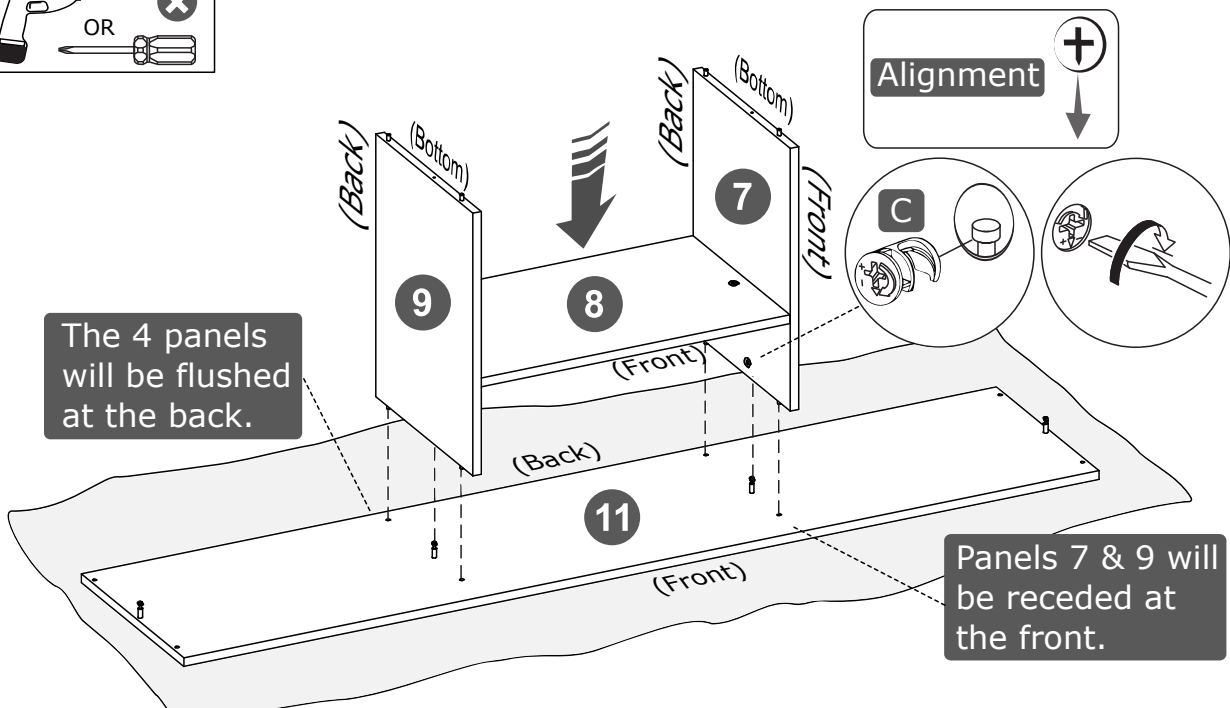

- **FIRST** place the main top panel **11** upside-down and over a large tablecloth or blanket to protect its finish, and identify its front edge.
- **THEN** assemble panels **7** and **9** from step **3** to panel **11** on the middle with cam locks **C**, with all the front edges oriented as shown.

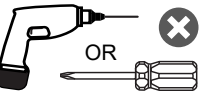

STEP 5

Hardware

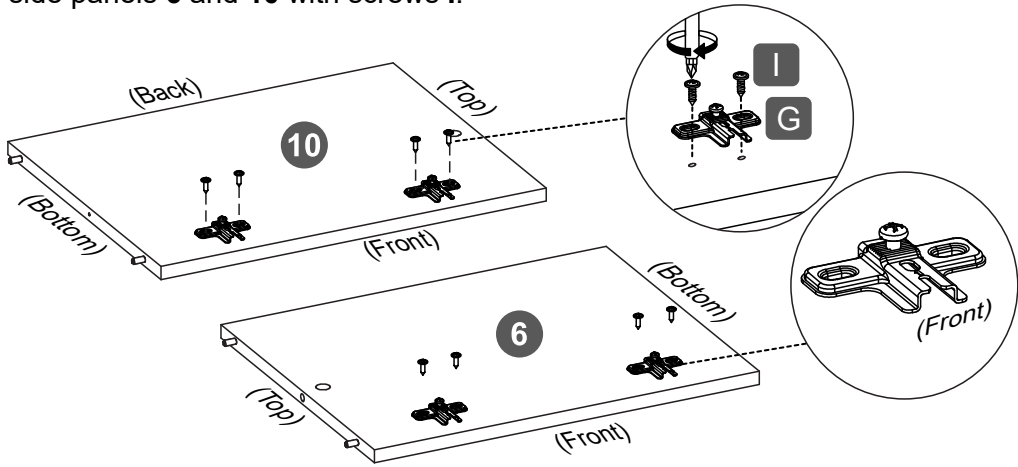

I	 M3.5x12	8 Pcs
G	 Fixed hinge	4 Pcs
Tools (Not included)		
 OR 		

Pay attention to the orientation of the fixed hinges **G**, and attach them to the side panels **6** and **10** with screws **I**.

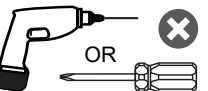

STEP 6

Hardware

C	 Cam lock	2 Pcs
Tools (Not included)		
 OR 		

Assemble the side panels **6** and **10** to the top main panel **11** with cam locks **C**.

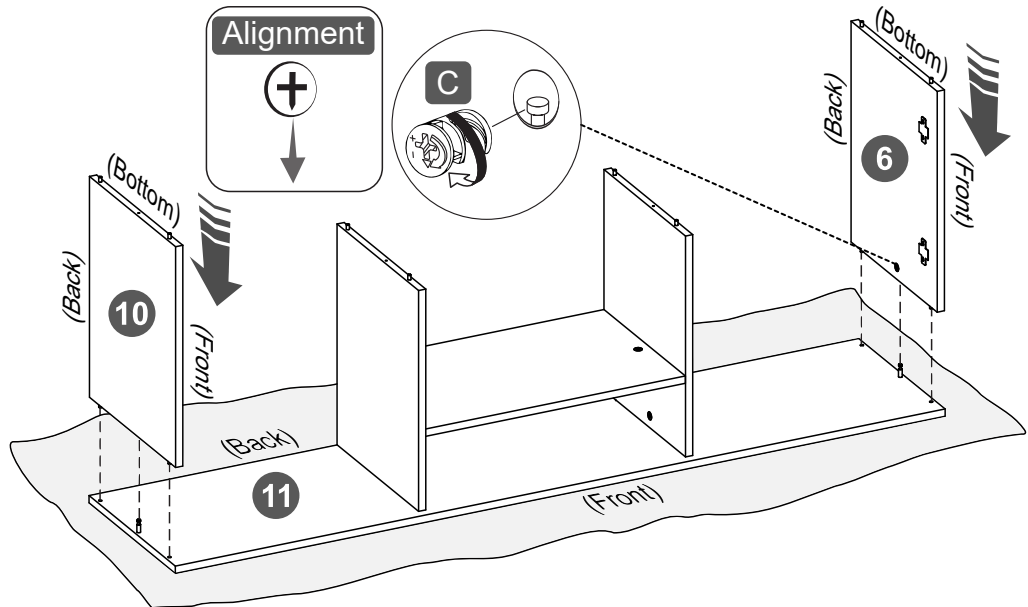



STEP 7

This step requires of 2 persons

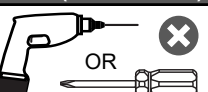

Hardware

A	 M4x50	4 Pcs
Tools (Not included)		
 OR 		

With the help of another person, assemble the lower panel **5** to the panels **6**, **7**, **9** and **10** with screws **A**. Pay attention to the orientation of the panel, and when finished, all the panels will be flushed at the back, but panels **7** and **9** will be receded at the front.

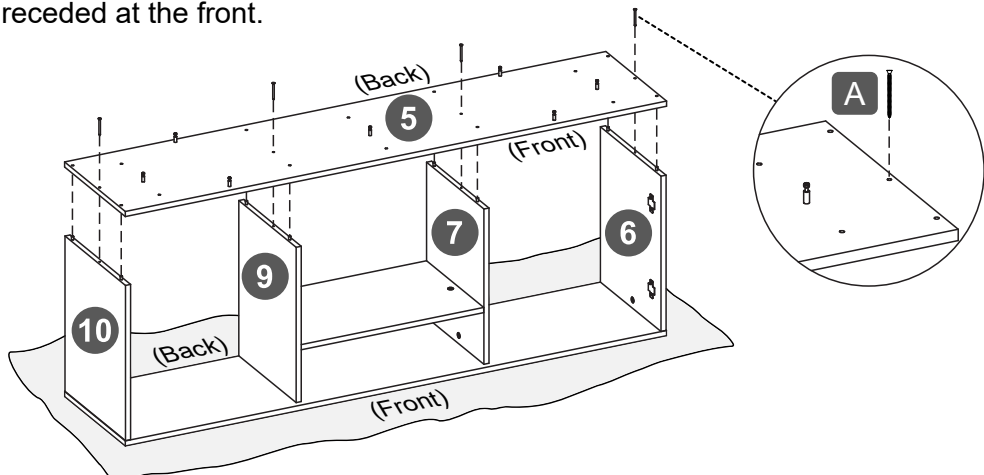

STEP 8

Hardware

E		8 Pcs
J		8 Pcs

Tools (Not included)

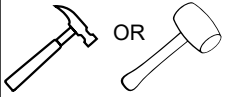

On the indicated profile of the skirting boards **1** and **4** install 2 pieces of the glide feet **E** using nails **J** at approximately 2" from each end, then another 2 pieces **E** in the middle at equidistant length.

2" from each end

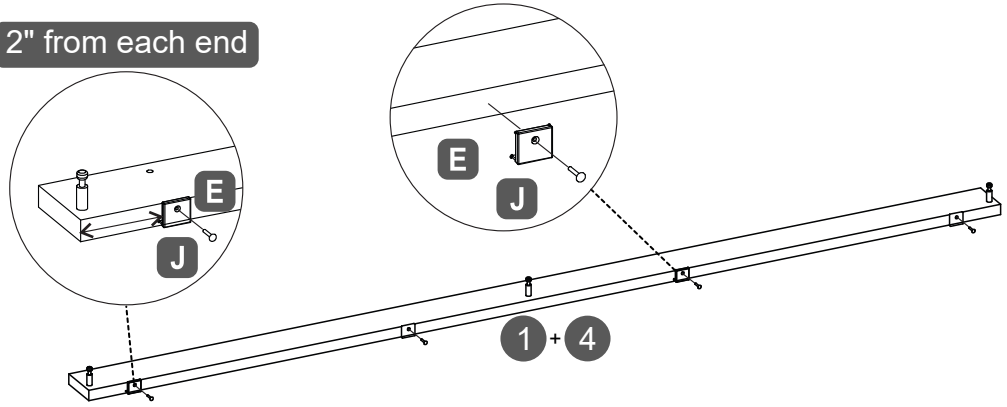

STEP 9

Hardware

C		6 Pcs
----------	---	-------

Tools (Not included)

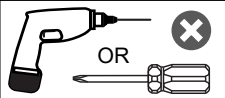

Assemble the skirting boards **2** and **3** in between the skirting boards **1** and **4** with cam locks **C** as shown.

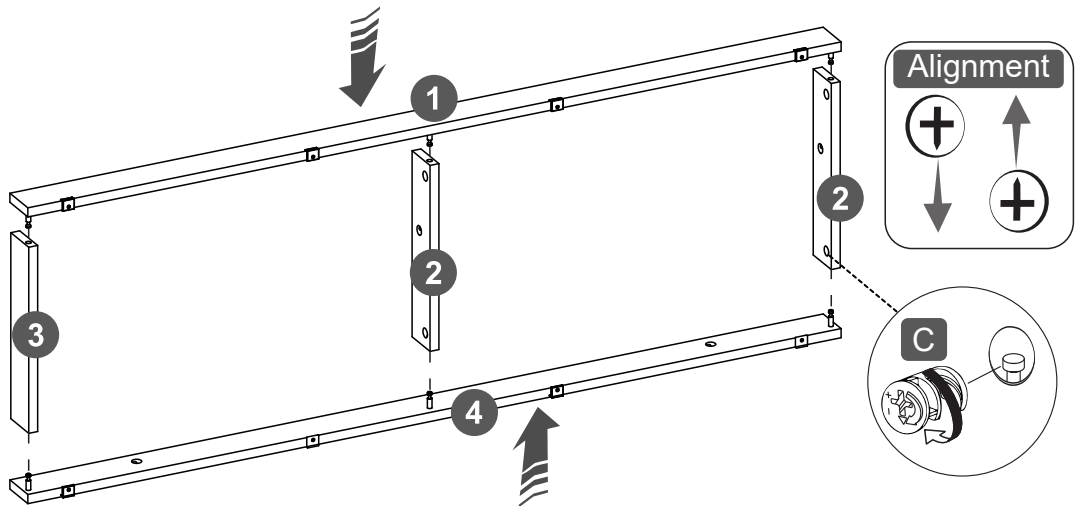

STEP 10

This step requires of 2 persons 

Hardware

C		7 Pcs
----------	---	-------

Tools (Not included)

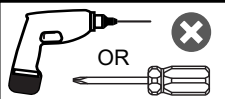

With the help of another person, assemble the base structure built on step 9 to the lower panel **5** with cam locks **C**.

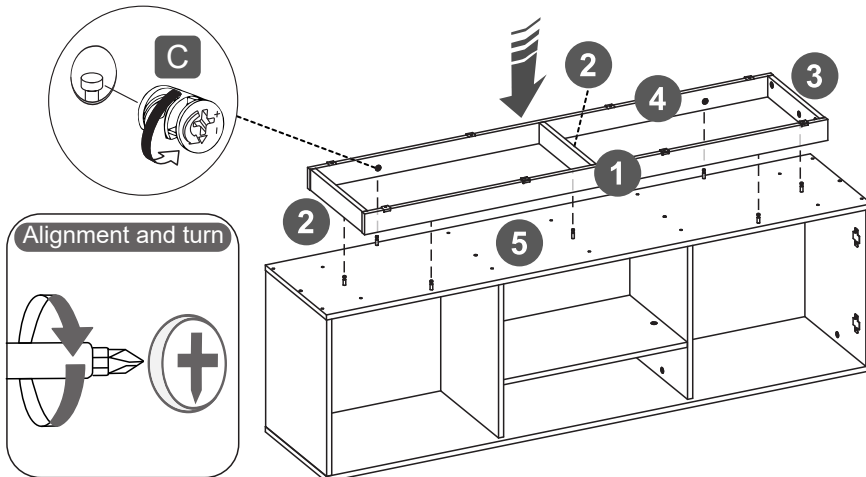

STEP 11

This step requires of 2 persons



Hardware

H		10 Pcs
J		52 Pcs
L		2 Pcs
M		4 Pcs

Tools (Not included)

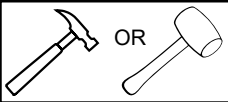

- **FIRST**, and with the help of another person, carefully flip the unit over its front.
- **THEN** place all the back boards **15**, **16**, **17** and **18** over the unit on their respective places making sure they are flush with each other and their edges fit and are centered within the edges of the unit.
- **THEN** secure **ONLY** the outer edges of the boards with nails **J**.
- **THEN** place the metal junction plates **H** distributed along where the boards join each other, and secure them with nails **J**.
- **THEN**, and with the help of another person, carefully flip the unit upright.
- **LASTLY**, cover the cam locks with the respective stickers **L** and **M**.

FIRST: Flip

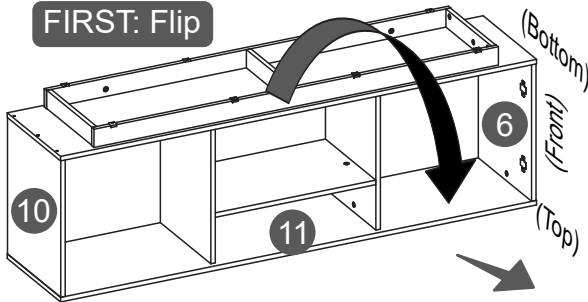

DON'T FORGET TO USE A BLANKET FOR PROTECTION OF SURFACES



SECOND

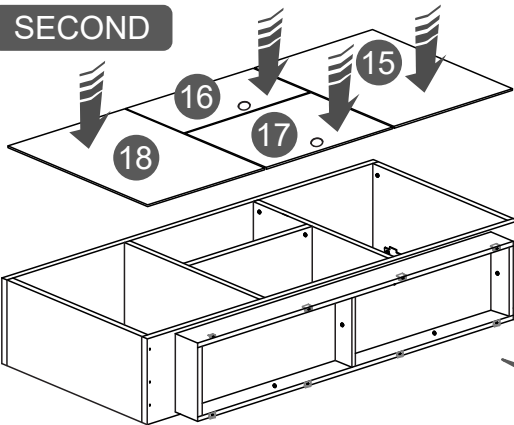

THIRD: Outer edges ONLY

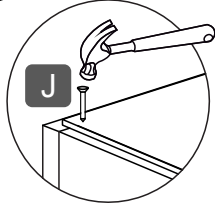
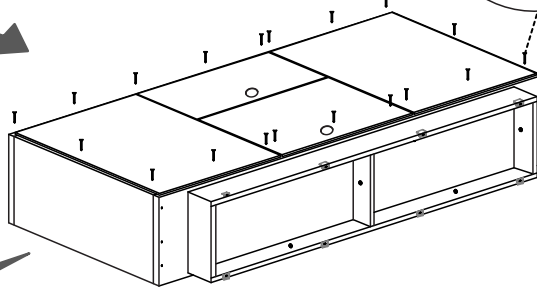

FOURTH: Along junctions

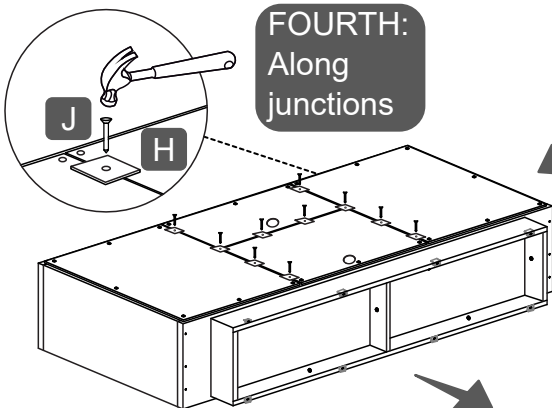

LAST: Apply stickers

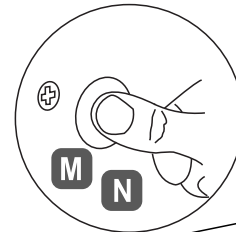

FIFTH: Flip

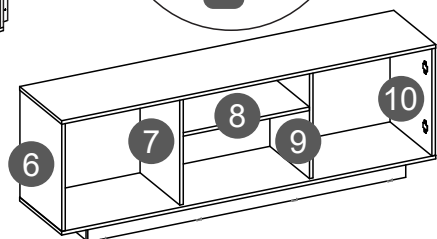
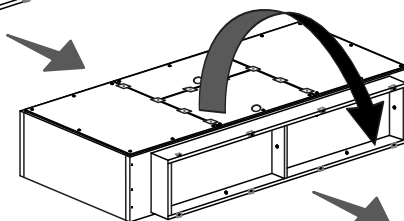

STEP 12

Hardware

K



Double
tape

40
Pcs

- **FIRST** place the decorative panels **13** and **14** upside-down and carefully peel-off and attach to each of them 20 pieces of the double-sided tape **K**, but **DO NOT PEEL OFF** on the top side until ready to join with doors **12**.
- **THEN** place the doors **12** with the big holes facing down, and side by side.
- **THEN** carefully peel-off the tapes from **13** and **14**.
- **LASTLY**, and very carefully, slowly and steadily, place the ornament panels over the exterior surface of the doors **12**.

FIRST: Peel-off K on one side **ONLY**, and attach to the ornaments **13** and **14**

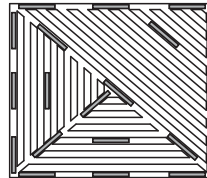
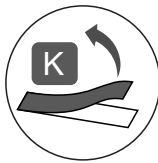

13 Unfinished side

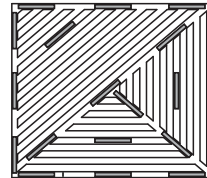

14 Unfinished side

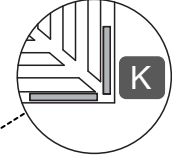

THEN: Have ready the doors **12** oriented as shown.

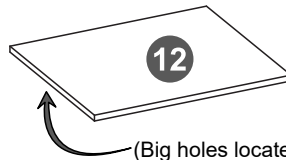

(Big holes located underneath and on this side)

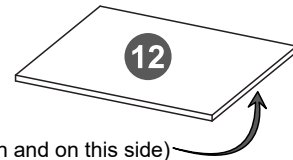

LAST: Peel-off K from the ornaments, and carefully attach them to the doors.

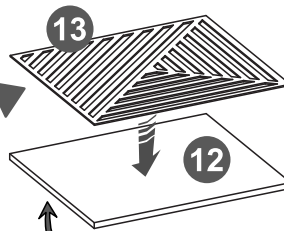
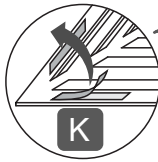

(Big holes located underneath and on this side)

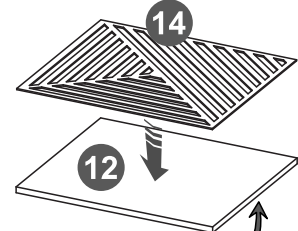

STEP 13

Hardware

I



M3.5x12

8
Pcs

F



Articulated
hinge

4
Pcs

Tools (Not included)

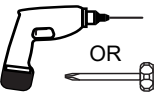

OR

Flip the doors **12** and attach to them the articulated hinges **F** with screws **I**.

FIRST: Flip doors, keeping them side-by-side

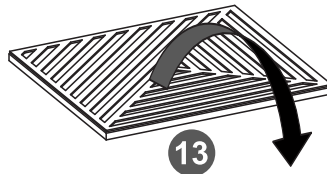

13

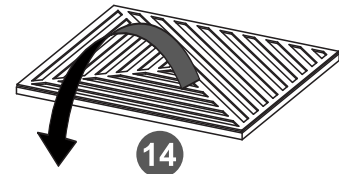

14

THEN: Attach the hinges

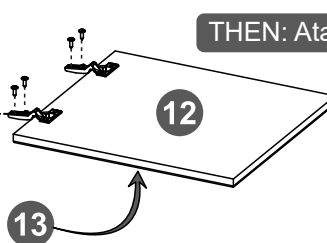
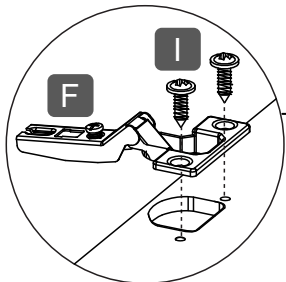

13

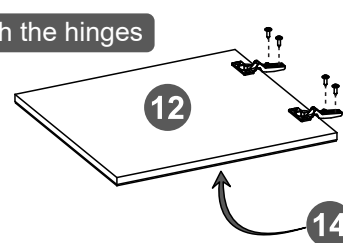

14

STEP 14

Tools (Not included)

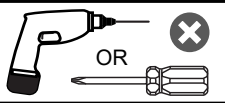

- **FIRST**, inside the unit loosen up the middle screws on the fixed hinges **G**, and on the doors **12** tighten the screw on the hinges **F** just a little bit to allow both pieces of hinges to connect well one to another.
- **THEN**, install the doors **12** to the side panels **6** and **10** on the unit by connecting the articulated hinges **F** to the fixed hinges **G**, and tightening the screws on **G**.
- **LASTLY**, and to ensure that the doors will close smoothly, adjust their alignment by loosening the indicated screws, aligning the door, then re-tighten the screws. You might have to play a little bit with the different adjustments.

FIRST: Adjust these screws

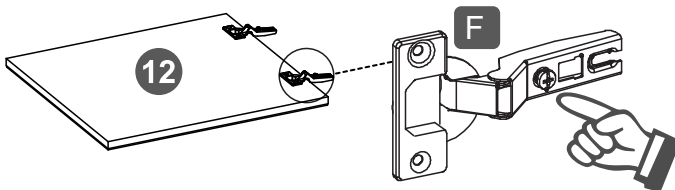

Tighten on F
(But just a little bit)

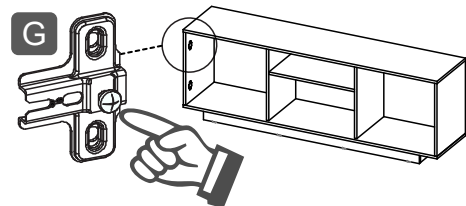

Loosen on G
(But just a little bit)

THEN: Install the doors

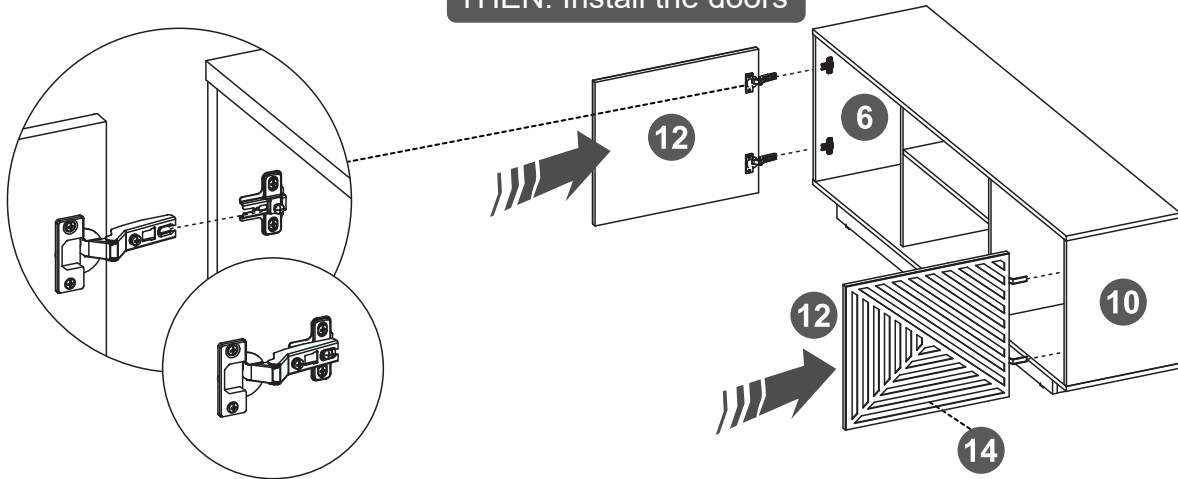

LAST: Adjust the doors

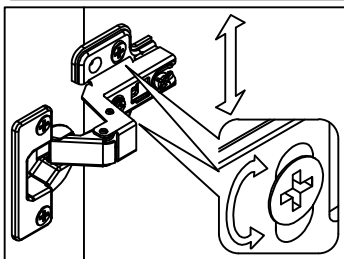

To adjust the height, loosen up these screws, align, then re-tighten

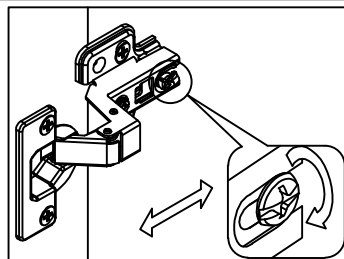

To adjust the depth, loosen up this screw, align, then re-tighten

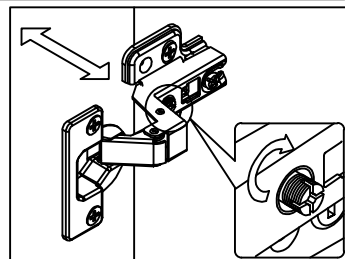

To adjust side-to-side, loosen up or tighten this screw.

WEIGHT LIMITS

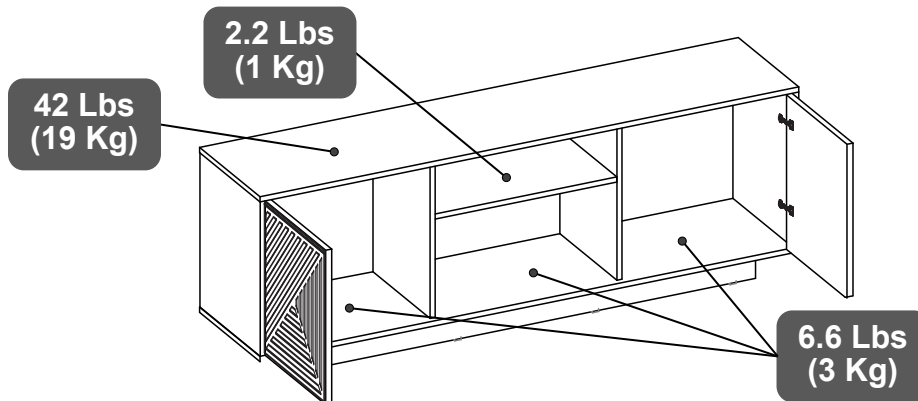

WARNINGS

- Always pay close attention to small children playing near the unit or when they are watching TV very close to it to prevent tip-over accidents.

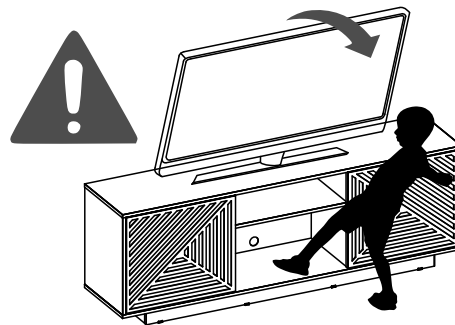
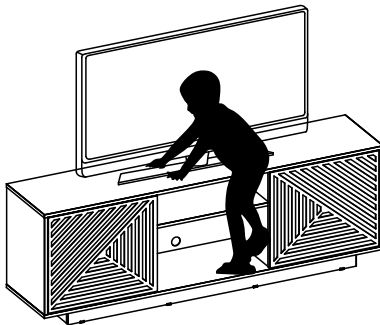

- Do not exceed the indicated weight limits.
- Do not expose the surfaces to direct sunlight or to extreme environmental conditions.
- Do not use solvents or abrasive materials to clean the unit.
- Do not sit on the unit or lean against it.
- Do not allow small children to play over or inside the unit.
- Do not pull, push or drag the unit to move it for more than 1 feet. The unit must be lifted by at least 2 persons when moving in the same or adjacent rooms.
- Before moving the unit, secure or remove your TV and objects that are heavy or might fall off.
- When lifting the unit, use both hands and bend your knees, not your backs.
- Do not use the product if screws are loose or missing, or if you notice damaged parts.
- The warranty does not extend to regular wear and tear, nor the manufacturer assumes liability for damages or consequences due to accidents, incorrect assembly, negligence, improper use, modifications, or not heeding the above warnings.

CARE AND MAINTENANCE

- Clean the surfaces preferable with a clean cloth damped in a solution of mild soap and water, then dry with a clean towel.
- If you decide to use a cleaning agent, test first on an area hidden from view such as underneath the tabletop.
- Every 4 months, inspect the unit completely and make sure that all screws are tighten.
- When transporting the unit to places far away, protect and secure the unit to avoid damage in transit.

TECHNI MOBILI WARRANTY**TV Stand/Entertainment Center: 2 YEAR WARRANTY**

RTA Products, LLC warrants to the Original Purchaser who acquired a new product from RTA Products or its authorized resellers that this product will be free from defects in its workmanship and materials, under normal use and service conditions, as described herein. "Defects" as used in this warranty, is defined as any imperfections that impair the use of the furniture or product. RTA products will repair or replace, at its option, without charge to the original purchaser 'other than freight from purchaser to RTA Products, only the defective products or parts for a period of TWO (2) Years.

Replacement parts can only be supplied if parts are available. Items out of production may be unavailable. This warranty will be effective for the applicable time period beginning the date of purchase on your original sales receipt. RTA product's obligation under this warranty is limited to repairing or replacing products or parts as provided herein. This product has been designed for and is intended for office and home-office use only. This warranty is Original Purchaser's sole remedy for product defects, and this warranty does not extend to any product, or damage to any product, caused by or attributed to abuse or misuse, products used for commercial or rental purposes, use modifications of, or attachments to the product, and products or parts not used, maintained, or extended hereunder is in lieu of any and all other warranties, express or implied, including without limitations any implied warranty or merchantability or of fitness for a particular purpose. Please note, all desks made with PVC Laminate surface should not be exposed to direct sunlight, as it may damage the material. Damage of this nature is not covered under this warranty.

RTA Products will not be responsible for indirect, special, incidental or consequential damages. This warranty is limited to merchandise purchased in the Continental United States, excludes AK, HI and PR. Some States do not allow the exclusion or limitation of incidental or consequential damages, so the above limitations or exclusions may not apply to you. This warranty gives you specific legal rights. You may also have other rights that may vary from state to state.

To file a Claim within the 48 contiguous United States: Email us to warranty@rtaproducts.com to explain the defect and provide your name, address, phone number, model number of our product, date and place, and proof of purchase. Please provide pictures of the damage or defect.

If we determine that a replacement will remedy the situation, and in order to determine the extent or the cause of the defect, purchaser may be requested to send the part in question at purchaser's expense. Once we receive the part, we will examine it and determine whether the claim is valid (or not), and then proceed to send the replacement. We will ship the replacement at our expense.

Replacement Parts for International Customers & AK-HI-PR orders:

RTA Products will replace the part free of charge, while the customer is responsible for shipping costs plus any International local taxes or duties.