

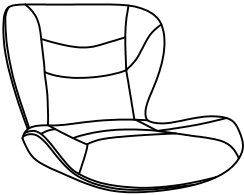
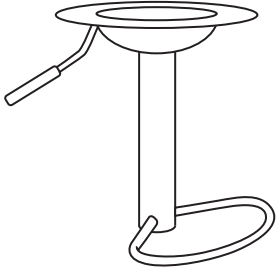
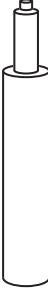
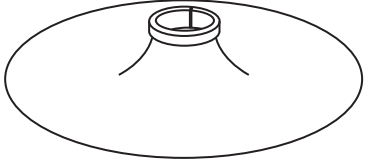

# INSTRUCTION MANUAL

# Bar Chair

## PARTS DESCRIPTION

A	B	C	D	E
				<p data-bbox="1358 369 1481 405"><b>M6*16</b></p>  <p data-bbox="1417 488 1465 517"><b>x4</b></p> 

## ASSEMBLE STEPS

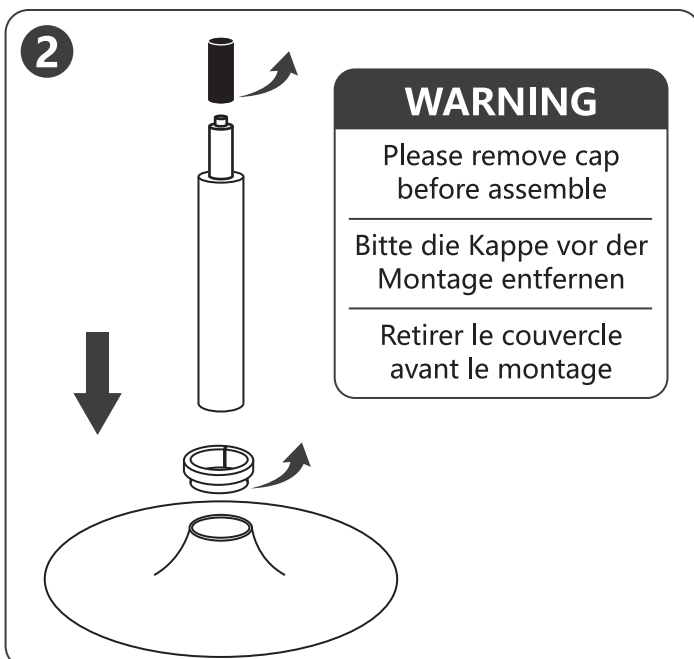
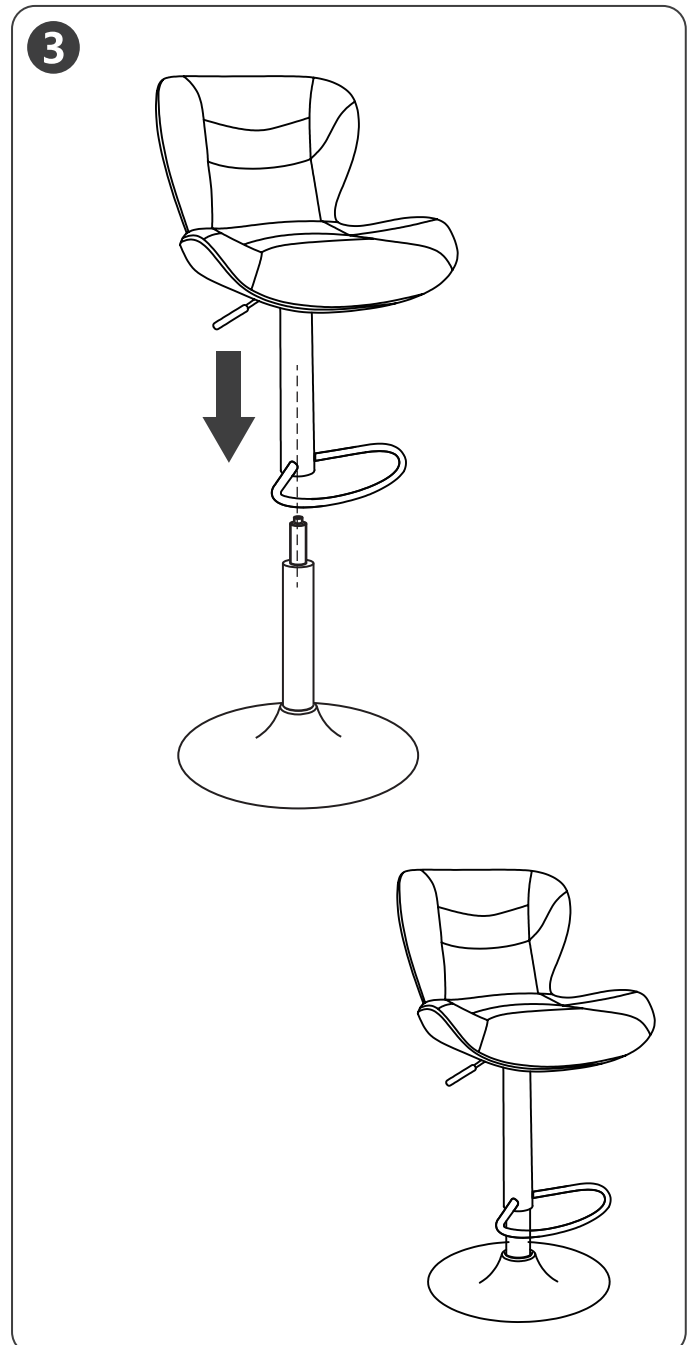
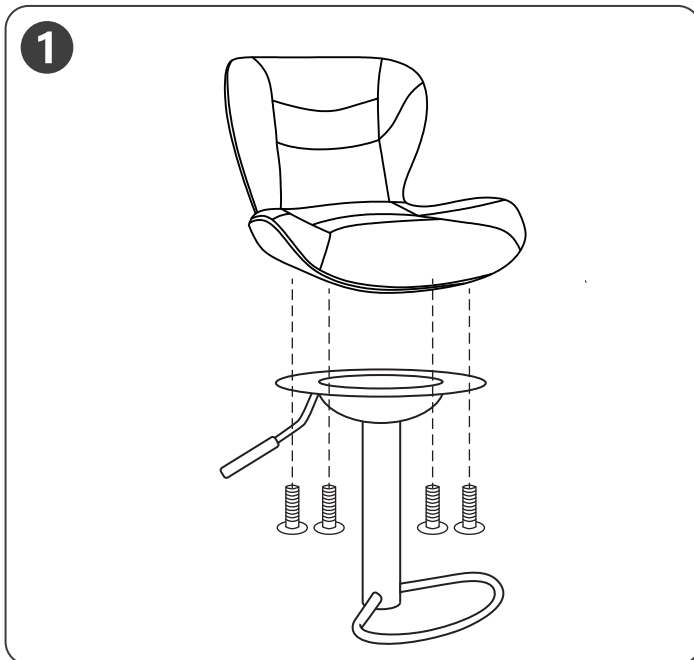

Please note: We provide fast after-sales service, don't worry if there is something wrong with the package you received. Please contact us first, we will reply you in time!