

INSTRUCTION MANUAL

EAGLE PEAK Wood Arbor

L 61 x W 23.6 x H 92 inches

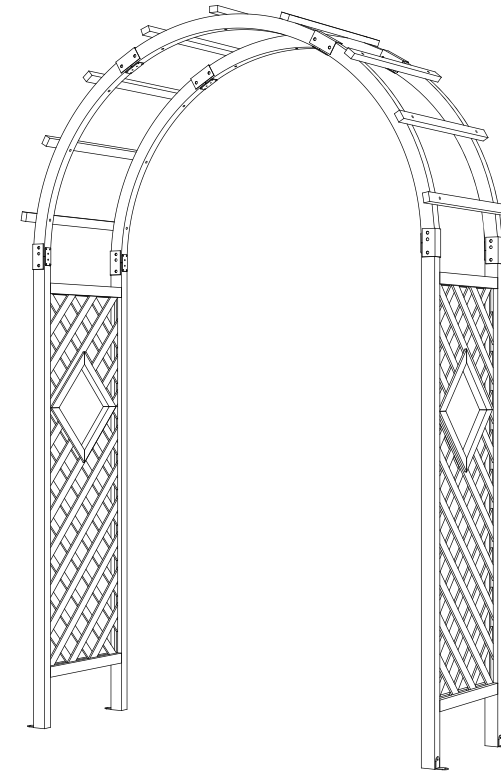

Step 3

- Attach Connector 2 (F) to the joint of Arc Frame & Side Panel (A) with Bolt & Nut (AA).
- Attach Connect Plate (E) to the joint of Arc Frame & Side Panel (A) with Self Tapping Screw (CC).

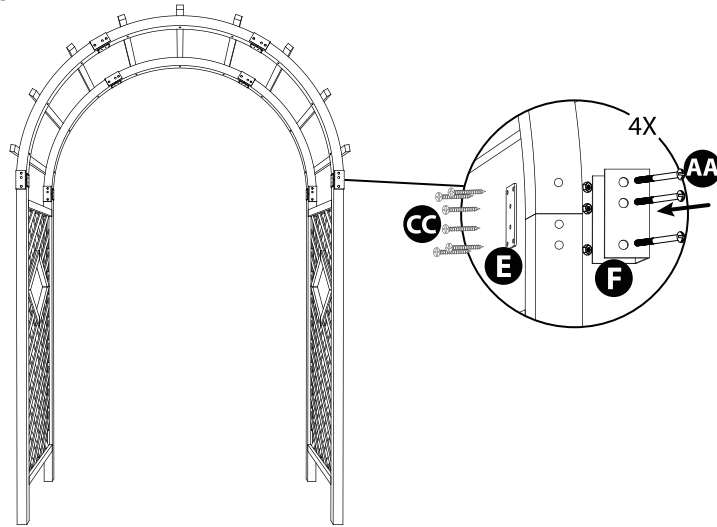

Step 4

- Attach L-shape Connector (G) to the bottom of Side Panel (A) with Self Tapping Screw (CC).
- Anchor the arbor to ground with L-shape Connector (G) using Stake (DD).

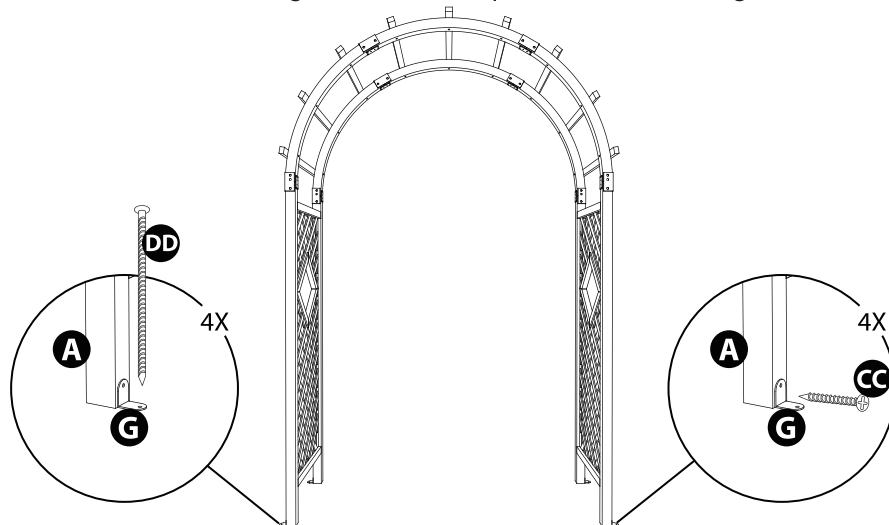









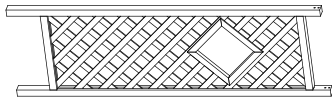

Thank you for choosing Eagle Peak!

Before You Begin:

- Please read and save the instruction manual before attempting to use your arbor.
- This product cannot be used as a horizontal bar.
- Keep all flame and heat sources away from this arbor.

Part List:

NO.	Description	Sketch	QTY.
A	Side Panel		2
B	Arc Beam		6
C	Ceiling Tube		9
D	Connector 1		4
E	Connect Plate		8
F	Connector 2		4
G	L-shape Connector		4
AA	Bolt & Nut M6 x 50		20+2
BB	Bolt & Nut M6 x 80		18+2
CC	Self Tapping Screw M4 x 20		52+5
DD	Stake		4

Set Up The Arbor

Step 1

- Screw three Arc Beam (B) with Connector 1 (D) by using Bolt & Nut (AA).
- Attach Connect Plate (E) to the joint of two Arc Beams (B) with Self Tapping Screw (CC).

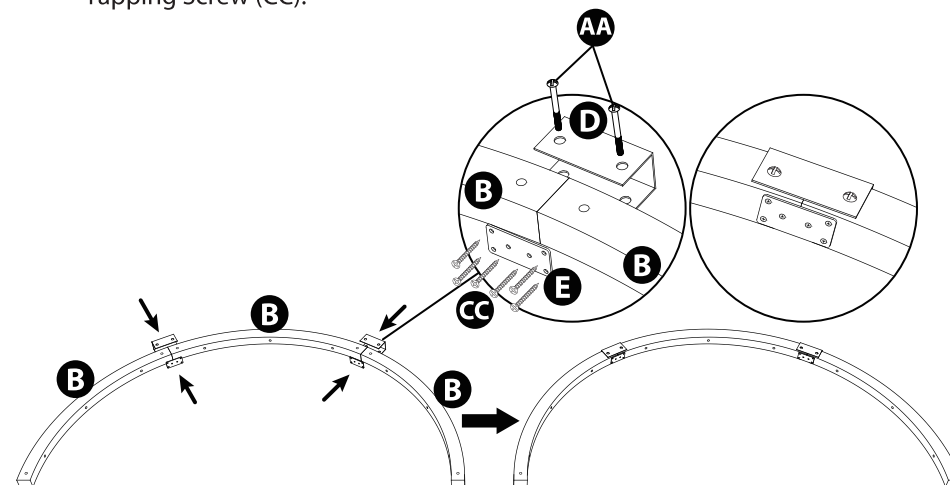

Step 2

- Attach Ceiling Tube (C) to Arc Beams using Bolt & Nut (BB).

