

Assembly Instructions

Left sofa

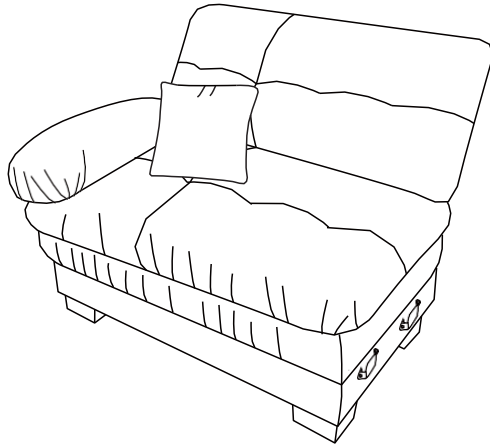

PARTS LIST

A

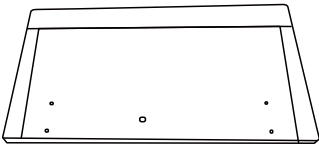

Backrest*1

B

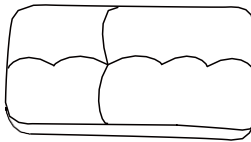

Left back cushion*1

C

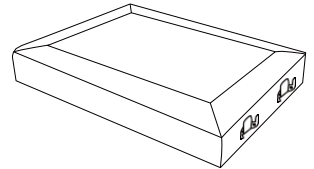

Left seat frame*1

D

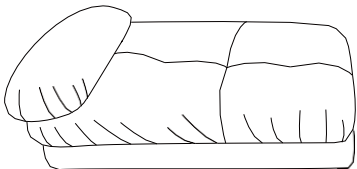

Left seat cushion*1

E

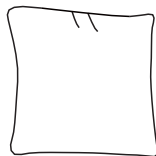

Pillow*1

F

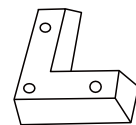

Leg*4

G

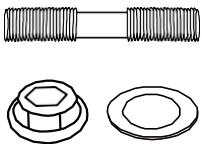

Bolt*5

H

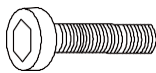

Bolt*12

I

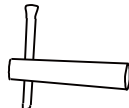

Allen key*1

J

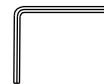

Allen key*1

Assembly Steps

Step 1

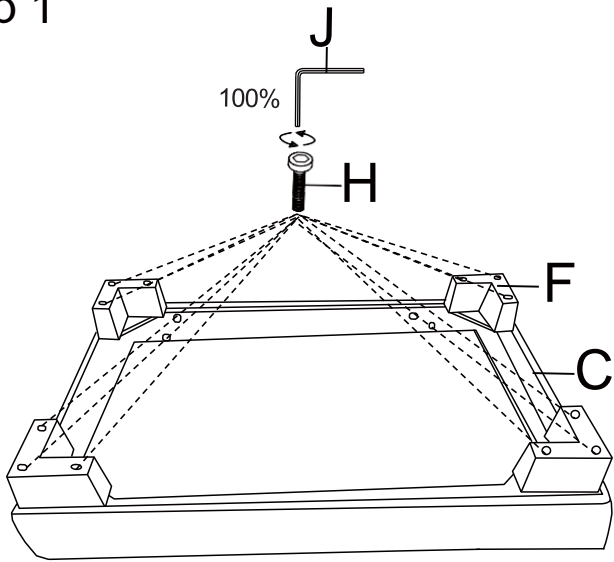

Step 2

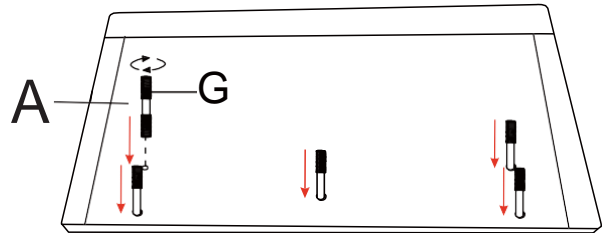

Step 3

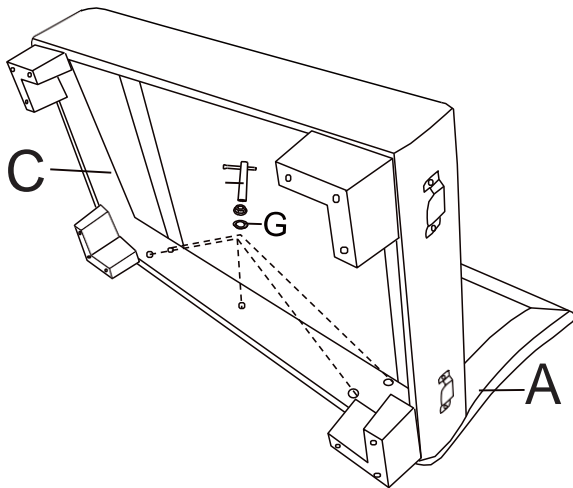

Step 4

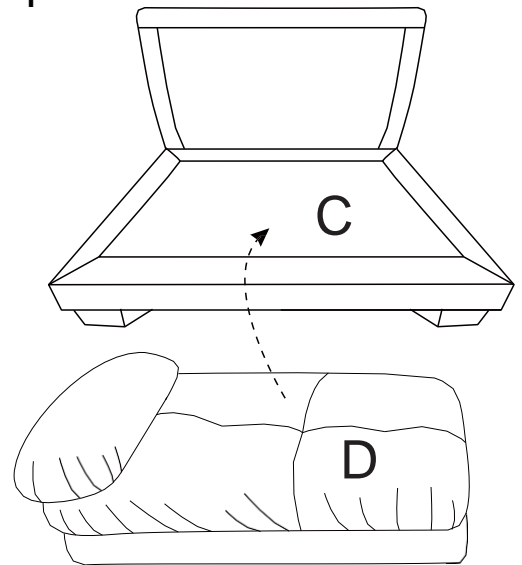

Step 5

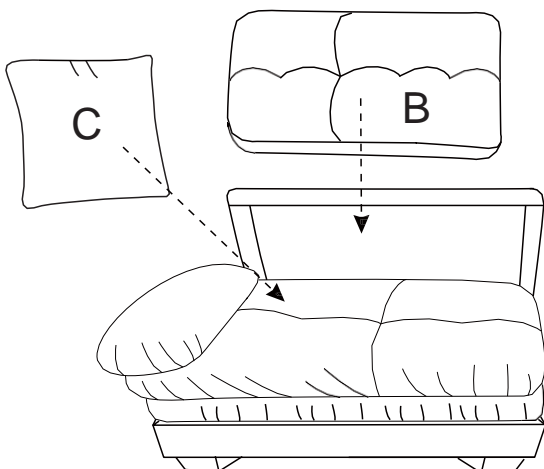

Step 6

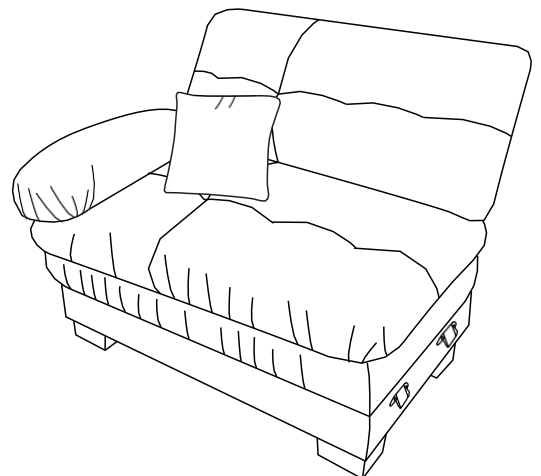

Assembly Instructions

Right sofa

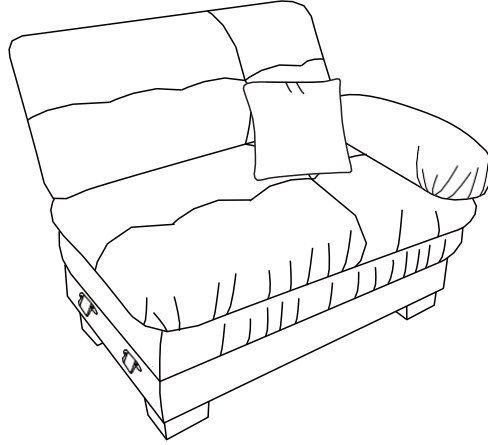

PARTS LIST

A

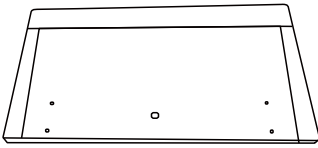

Backrest*1

O

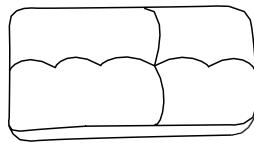

Right back cushion*1

P

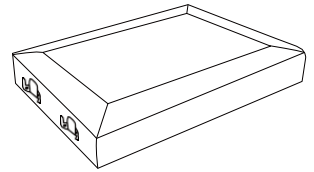

Right seat frame*1

Q

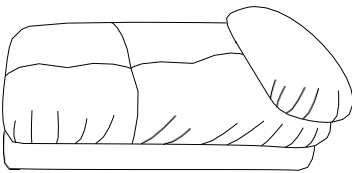

Right seat cushion*1

E

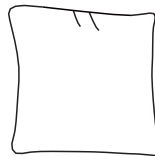

Pillow*1

F

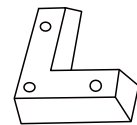

Leg*4

G

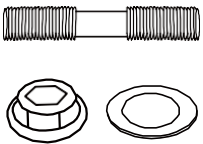

Bolt*5

H

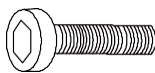

Bolt*12

I

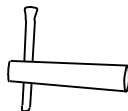

Allen key*1

J

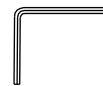

Allen key*1

Assembly Steps

Step 1

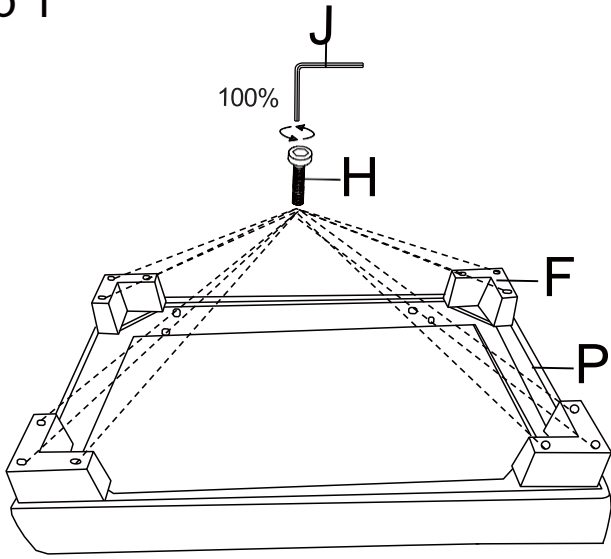

Step 2

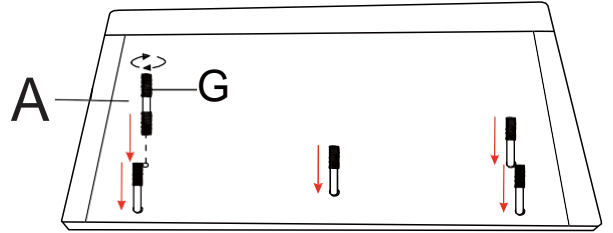

Step 3

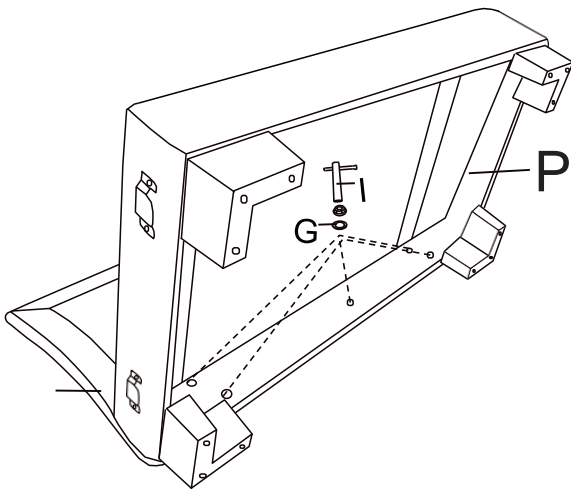

Step 4

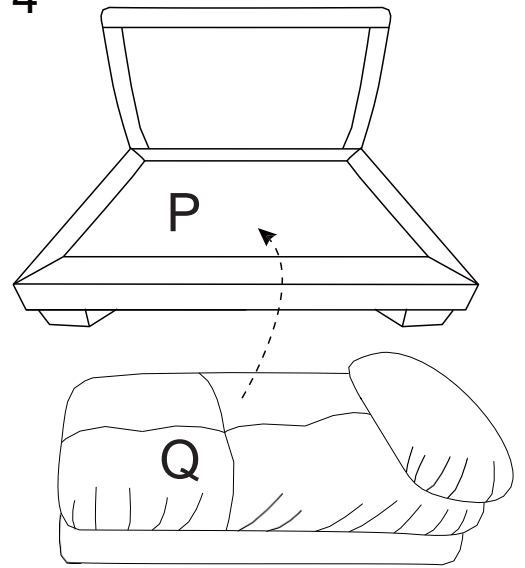

Step 5

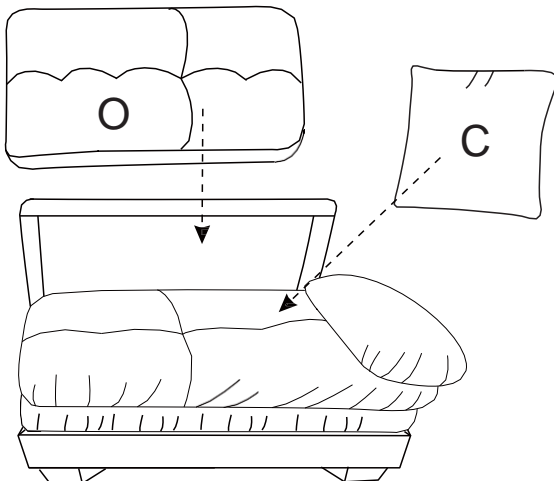

Step 6

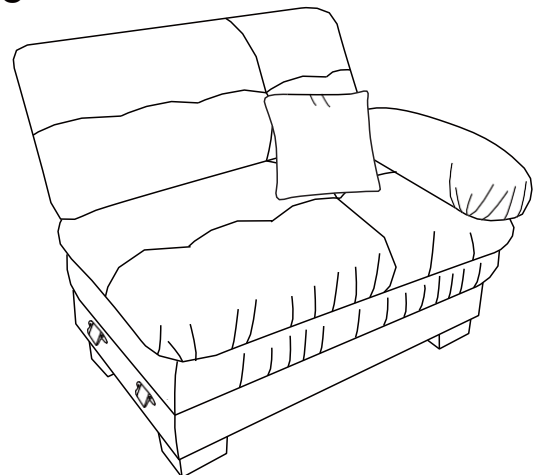

Assembly Instructions

Step 1

Attention:inside insert have connect

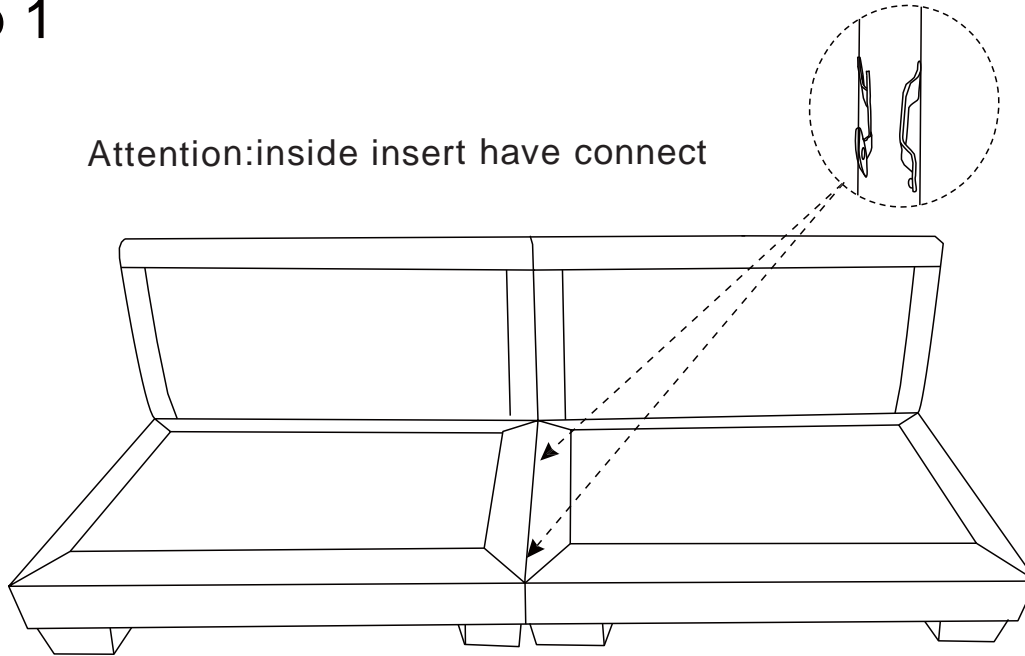

J



100%

