

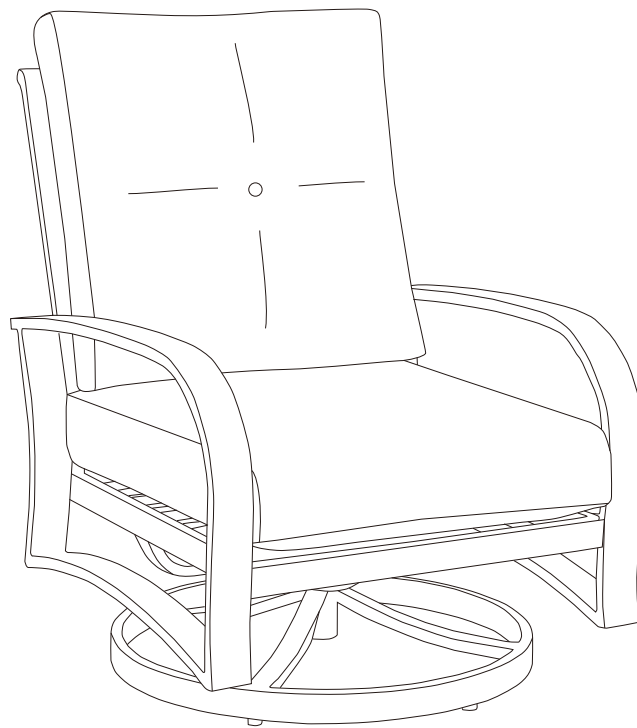

Aluminium Swivel Chair





Model#:970328







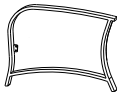
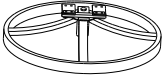
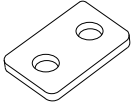

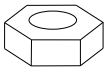
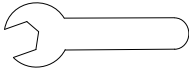
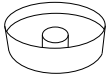

Read the instructions before use of this product.

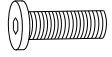
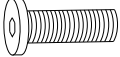
Please keep this instruction manual for future reference.



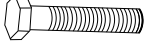
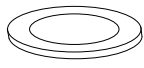









PARST & HARDWARE LIST			
Part	Part Image	Description	Qty
A		Back Panel	1
B		Seat Panel	1
C		Left Arm Panel	1
D		Right Arm Panel	1
E		Base	1
F		Metal Plate	4
G		Nut Cap	4
H		Nut	4
I		Wrench	2
J		Nut Cap	10

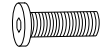

PARST & HARDWARE LIST			
Part	Part Image	Description	Qty
K		Bolt M6*20	4
L		Bolt M6*35	2
M		Bolt M6*65	4
N		Washer	10
O		Allen wrench	1
P		Nut Cap	4
Q		Bolt M8*50	4
R		Washer	8
S		Washer	8
T		Back Cushion	1
U		Seat Cushion	1



EXTRA			
Part	Part Image	Description	Qty
G		Nut Cap	1
H		Nut	1
J		Nut Cap	2
K		Bolt M6*20	1
L		Bolt M6*35	1
M		Bolt M6*65	1
N		Washer	2
P		Nut Cap	1
Q		Bolt M8*50	1
R		Washer	1
S		Washer	1

ATTENTION:

Keep children away during assembly. This item contains small parts that can be dangerous for children. Children should always be under direct adult supervision while using this product.

Do not discard any of the packaging until you have checked that you have all of the parts and fittings required.

Carefully remove the contents from the package. If any parts are missing, do not attempt to use the product until they have been obtained.

Make sure that each bolt needed for all steps matches the corresponding figure ensure proper assembly.

Step 1: Attach back panel (A) to left arm panel (C) using bolts (M), washers (N) and nut caps (J).

NOTE: Please do not fully tighten bolts until unit is fully assembled.

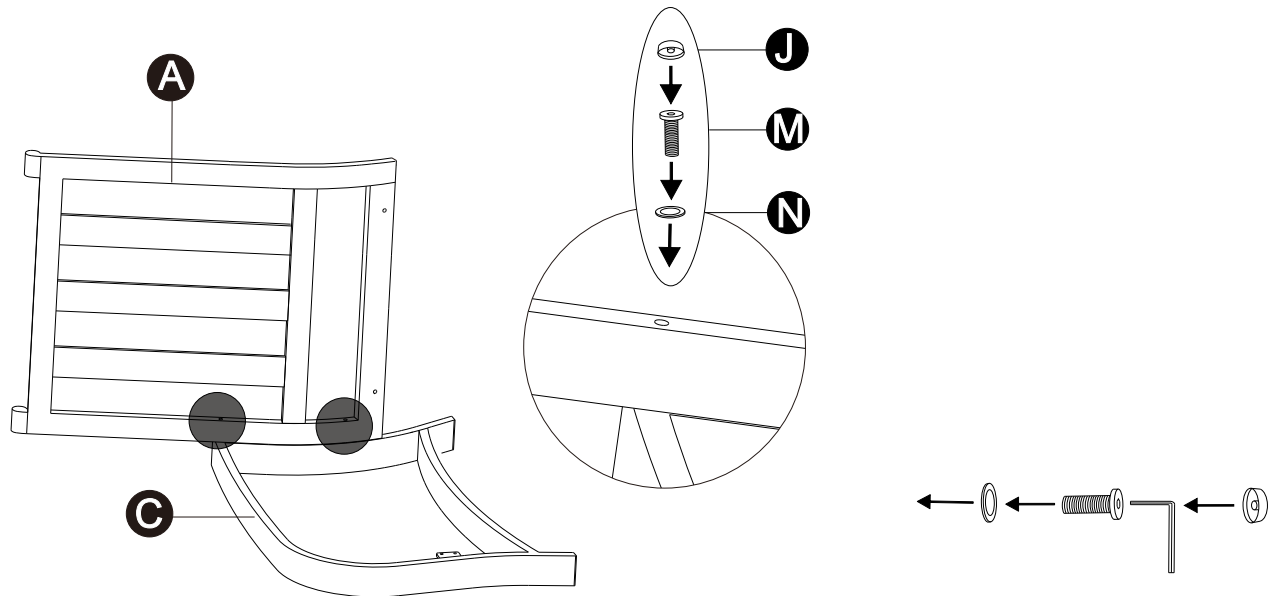

Step 2: Attach seat panel (B) to back panel (A) using bolts (L), washers (N) and nut caps (J).

NOTE: Please do not fully tighten bolts until unit is fully assembled.

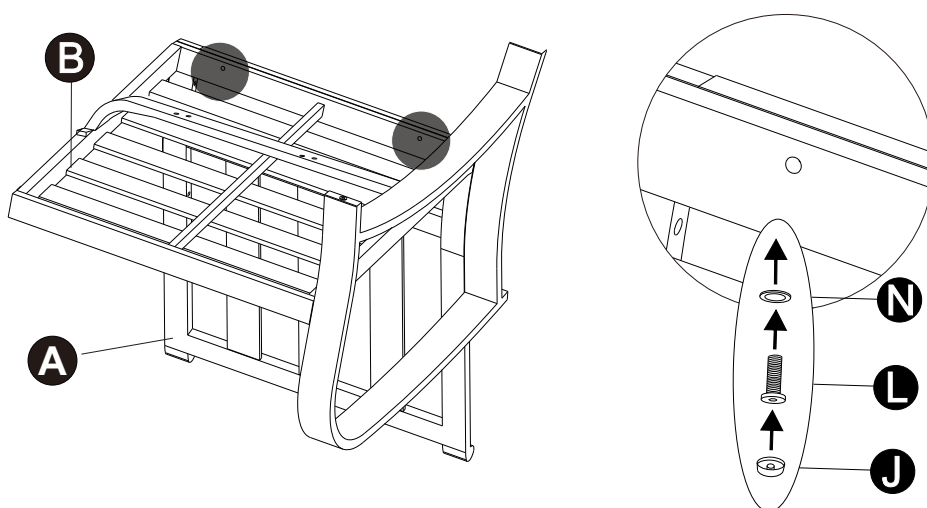

Step 3: Attach right arm panel (D) to back panel (A) using bolts (M), washers (N) and nut caps (J).

NOTE: Please do not fully tighten bolts until unit is fully assembled.

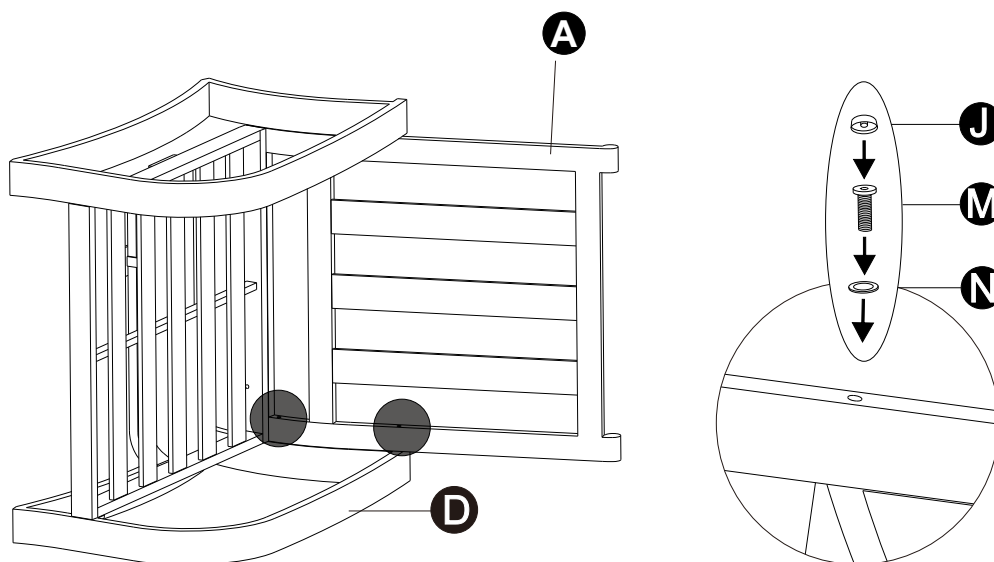

Step 4: Attach arm panel (D & C) to seat panel (B) using bolts (K), washers (N) and nut caps (J).

NOTE: Please do not fully tighten bolts until unit is fully assembled.

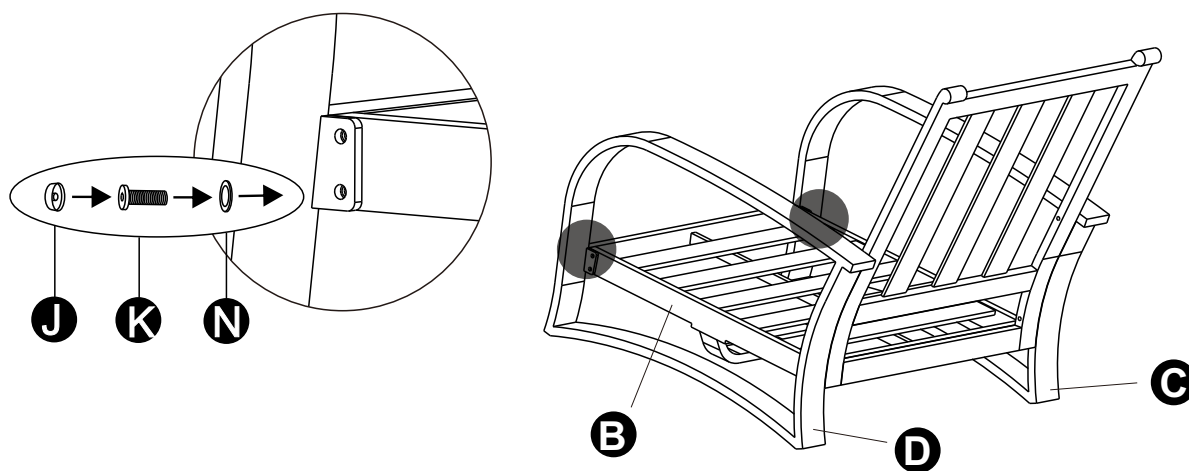

Step 5: Attach base (E) to seat panel (B) using metal plate (F), bolts (Q), washers (R & S), nuts (H) and nut caps (G & P).

NOTE: Please fully tighten all bolts at this time.

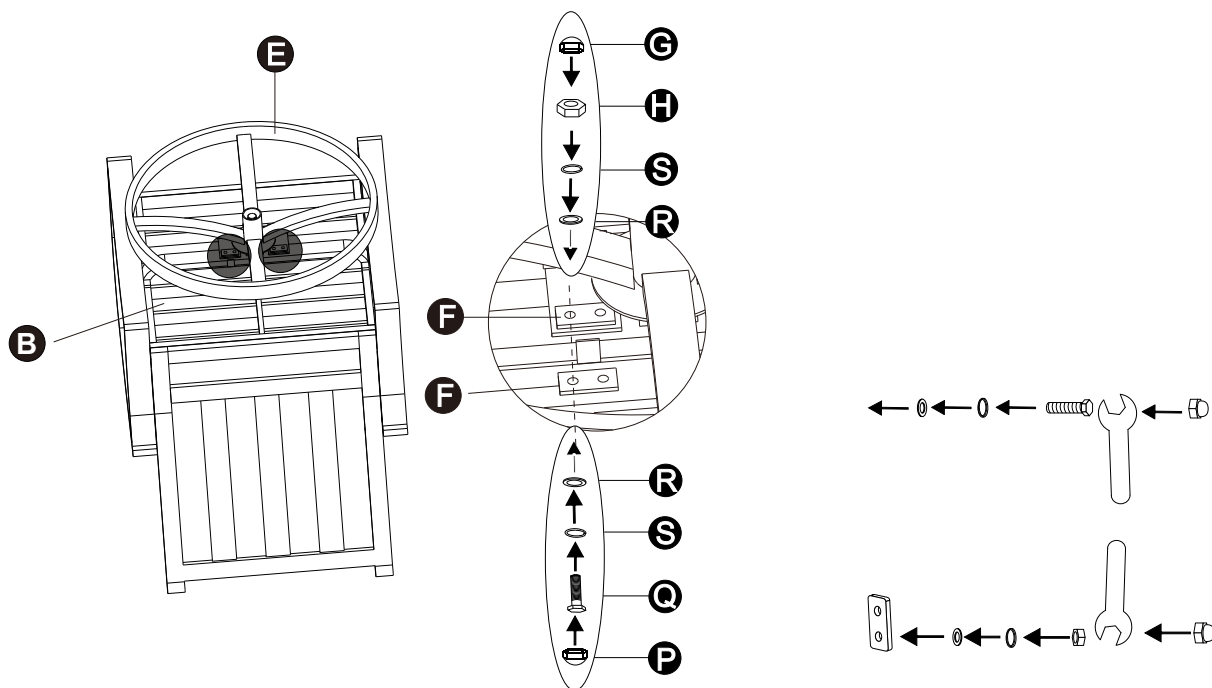

Step 6: Carefully turn unit upright.

Place back cushion (T) and seat cushion (U) as shown below.

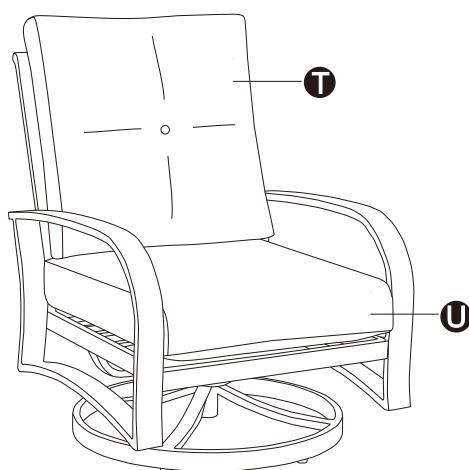

Cleaning and Maintenance

Clean frame with mild soapy water, rinse thoroughly. Dry frame parts completely. Do not use bleach, acid, or other solvents on the fabric and metal parts. We recommend the use of furniture covers to protect the Arm Chair when not in use.

Inspect and tighten all bolts on a regular basis to ensure proper performance and safety.

In order to prolong the life and beauty of your swivel chair, we recommend storing it in a dry and protective area during off season periods.



PEAKHOME FURNISHINGS INC.
970 Roosevelt #202, Irvine, CA 92620
www.peakhomefurnishings.com

CONTACT US

Toll free: 1-818-963-1558 Mon-Fri 10am - 6pm PST
Email: phf@peakhomefurnishings.com

If we missed you call, please leave a detailed message including your name and phone number. We will call back as soon as possible.

SOCIAL MEDIA

Follow us on our Social Media by uploading a picture of our brands furnishings in your home, you will have chance to get our newest product free.

 [Facebook.com/Peak-Home-Furnishings-Inc-103544141243786/](https://www.facebook.com/Peak-Home-Furnishings-Inc-103544141243786/)

 [Instagram.com/peakhomefurnishings](https://www.instagram.com/peakhomefurnishings)

 [Twiter.com/peakhomefurnis1](https://twitter.com/peakhomefurnis1)