

Installation & Assembly

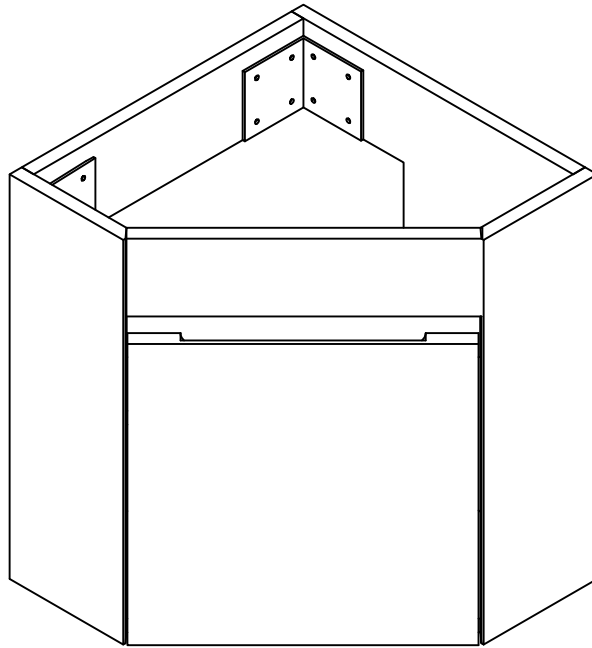

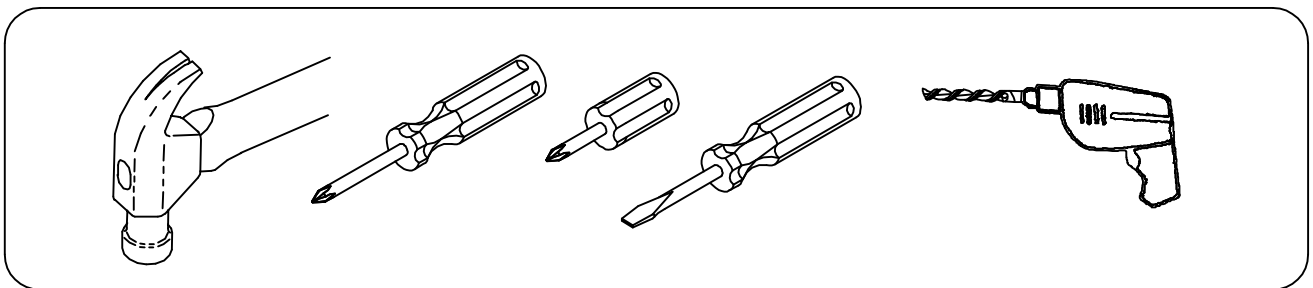





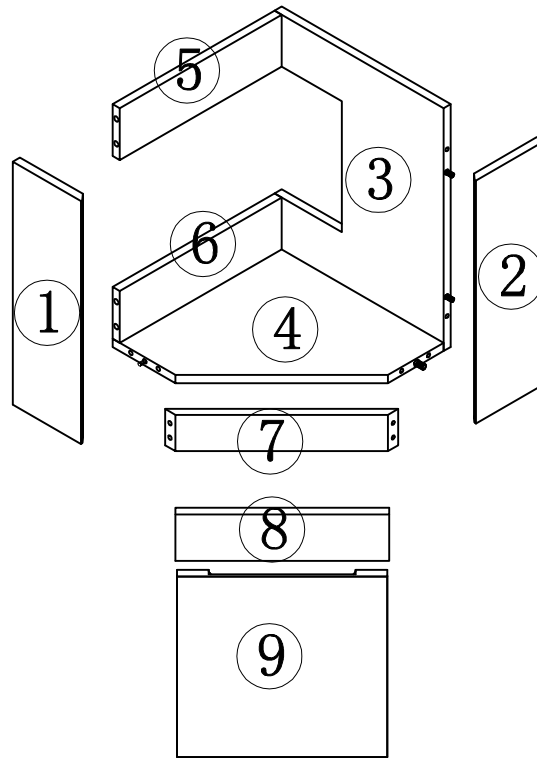









YOU MAY NEED (NOT SUPPLY)





ASSEMBLY DIAGRAM



PARTS LIST					
PARTS LIST					
NO	DESCRIPTION	QTY	NO	DESCRIPTION	QTY
①	Left side panel 	1	⑥	Rear baffle 	1
②	Right side panel 	1	⑦	Front drawbar 	1
③	Right side panel 	1	⑧	Front sealing plate 	1
④	Bottom panel 	1	⑨	Left door panel 	1
⑤	Rear baffle 	1			

PARTS LIST					
HARDWARE LIST					
NO	DESCRIPTION	QTY	NO	DESCRIPTION	QTY
A	Three-in-one eccentric wheel 	24	E	Door hinge 	2
B	Three-in-one connecting rod 	20	F	4*16mm screw 	28
C	Three-in-one sticker 	24	G	White angle bracket 	2
D	8*40mm wood dowel pins 	6	H	Adjustable angle 3-in-1 bar 	4
CAUTION: Please confirm the parts list before installation					

STEP 1

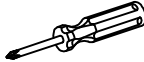
HARDWARE LIST		
Three-in-one connecting rod B  20PCS	Adjustable angle 3-in-1 bar H  4PCS	

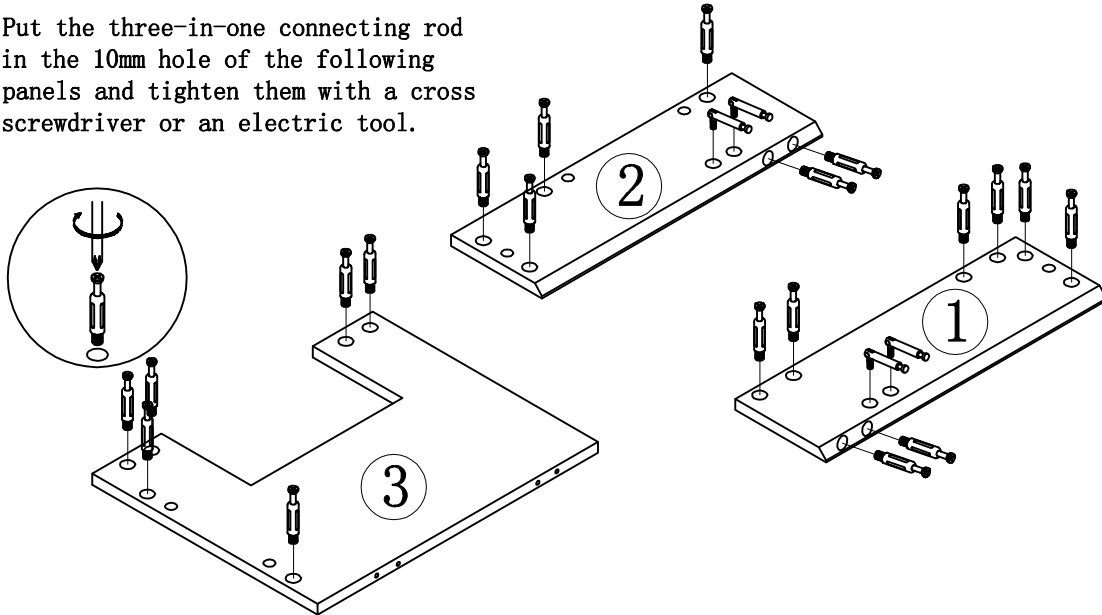

1. Put the three-in-one connecting rod in the 10mm hole of the following panels and tighten them with a cross screwdriver or an electric tool.

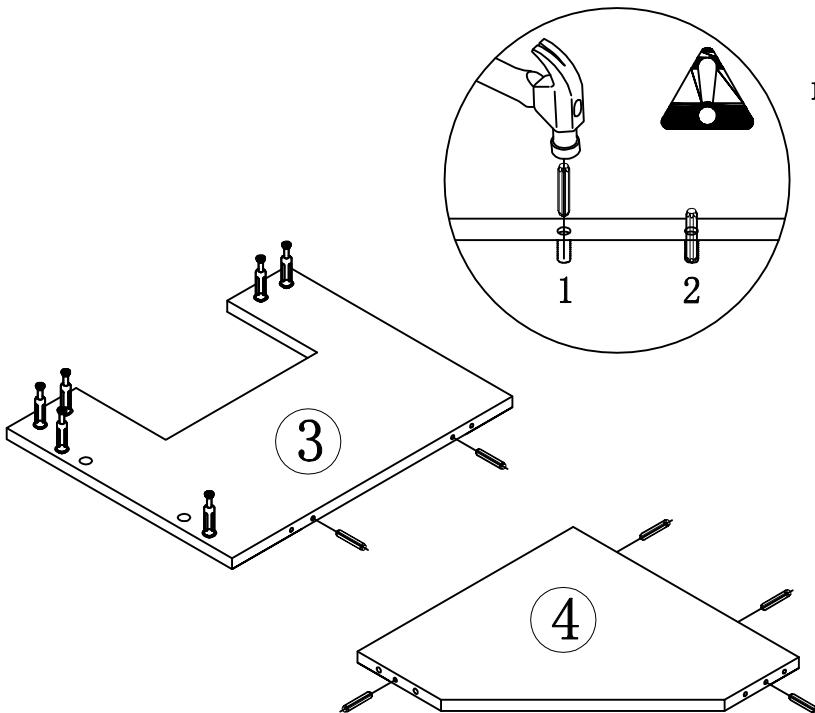

STEP 2



1. Strike the 08*40mm wood dowel pin into the 8mm hole of the above panels with an iron hammer. Please note that the hole of the three-in-one connecting rod should also be 8mm. The hole of the three-in-one connecting rod connects to the hole of 15mm three-in-one eccentric wheel.

HARDWARE LIST	
8*40mm wood dowel pins D  6PCS	

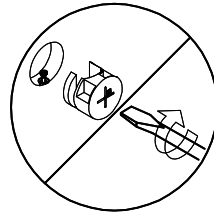
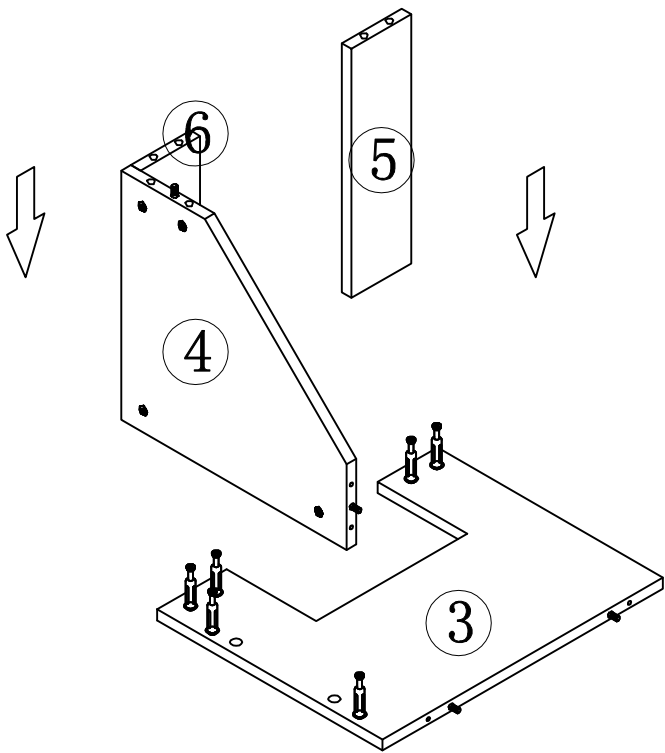

STEP 3

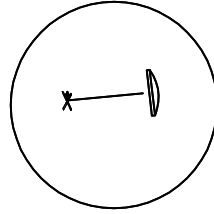

1. Connect No. 4-5-6 panel to No. 3 panel tightly with the three-in-one eccentric wheel.



2. Cover the mounting hole of the eccentric wheel with a three-in-one sticker.

HARDWARE LIST		
Three-in-one eccentric wheel A  6PCS	Three-in-one sticker C  6PCS	

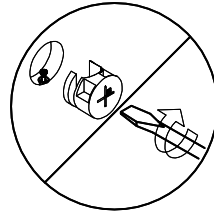
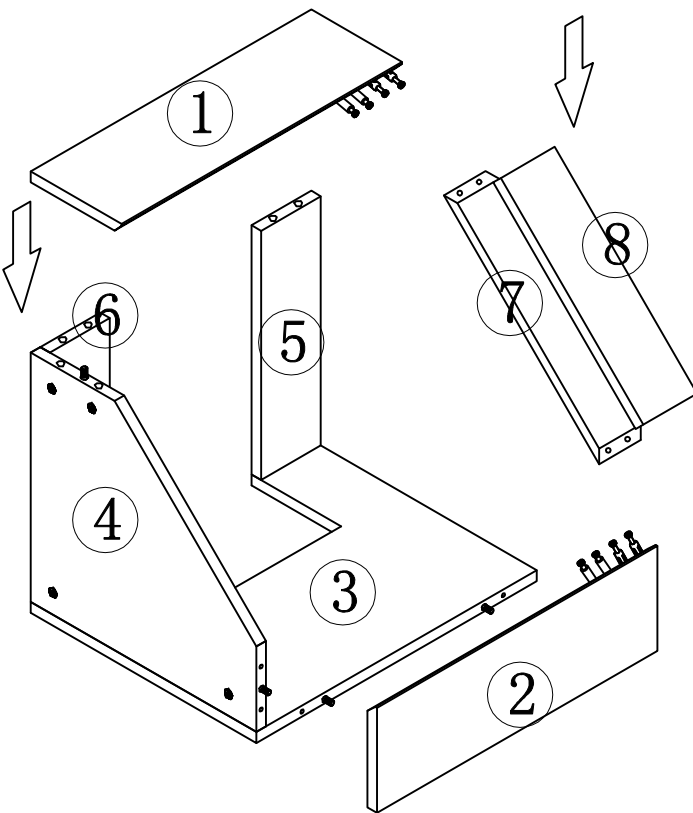

STEP 4

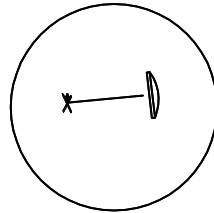

1. Connect No. 1-2-7-8 panel to No. 3-4-5-6 panel tightly with the three-in-one eccentric wheel.



2. Cover the mounting hole of the eccentric wheel with a three-in-one sticker.

HARDWARE LIST		
Three-in-one eccentric wheel A  18PCS	Three-in-one sticker C  18PCS	

STEP 5

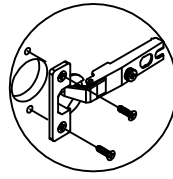
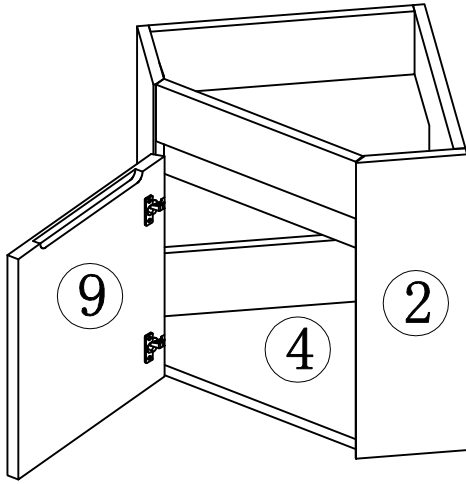

1. Install the hinge cup to the door panel with 4*16mm screws.

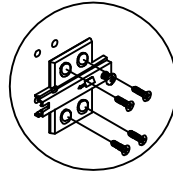

2. Install the hinge to the side panel with 4*16mm screws.

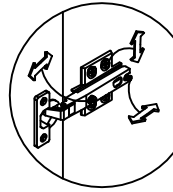

4. Adjust the door panel clearance.

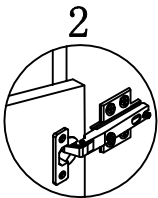
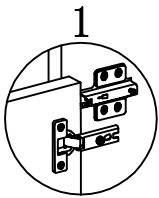

3. Install the hinge cup on the door panel to the hinge of the side panel.

HARDWARE LIST		
4*16mm screw	Door hinge	
F 12PCS	E 2PCS	

Hinge/Door Adjustment and Realignment

If adjustment or realignment is needed, follow the instructions provided in the following chart.

Vertical adjustment

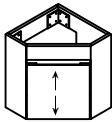

1. Loosen screws

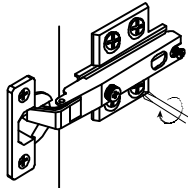

2. Adjust hinge

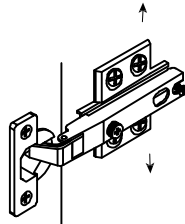

3. Tighten screws

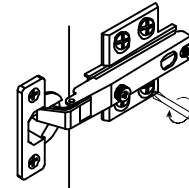

Horizontal adjustment

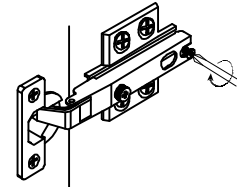
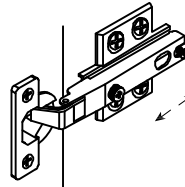
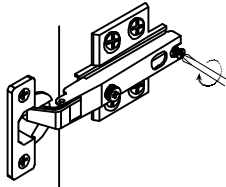
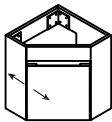

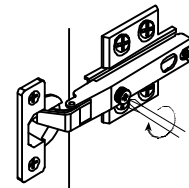
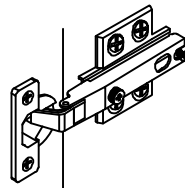
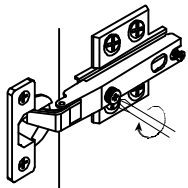
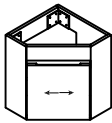

Door gap adjustment

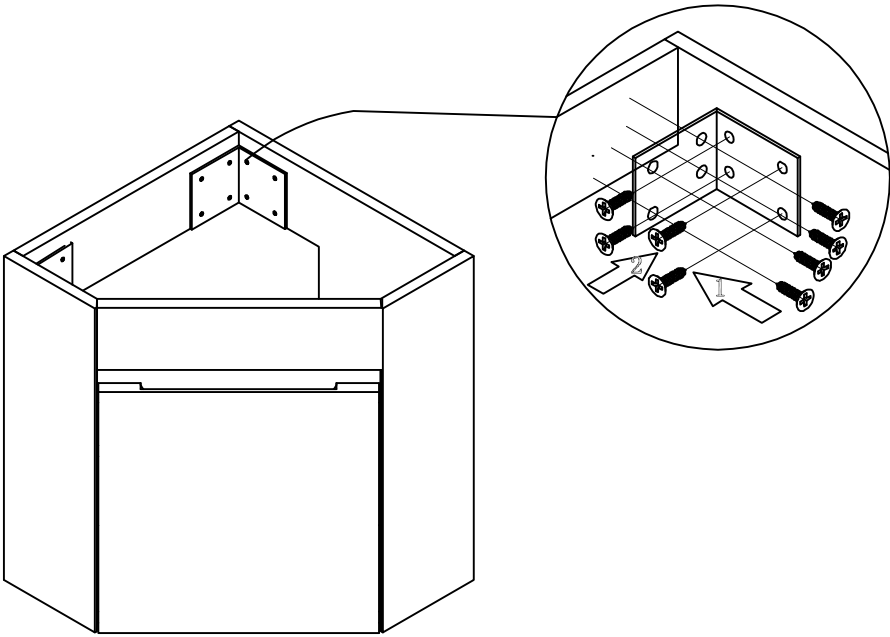

STEP 6

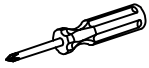

HARDWARE LIST		
4*16mm screw	White angle bracket	
F  16PCS	G  2PCS	

STEP 7

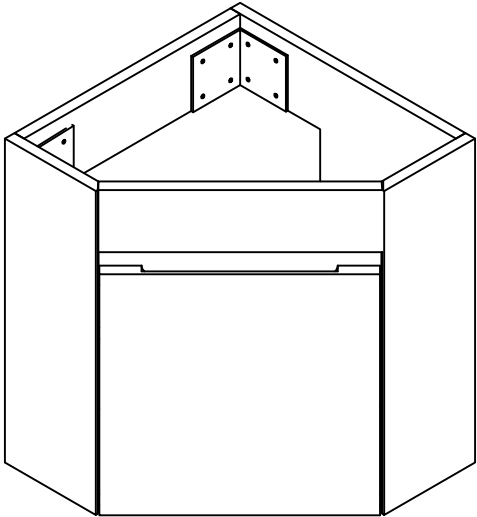



Choking hazard-Small Parts : This unit contains small parts, not for children under 3 years.

Tip-over hazard : Secure finished unit to wall stud using L-Bracket and wall screw (#10*1.5"W/out provided). If a wall stud is not neccessible , Consault your local hardware store for appropriate mounting hardware . Failure to properly install will result in product collapse or tip-over. Serious injury can occur .