

Back Removal Instructions

In some cases it is necessary to remove the back from the base of the seating unit.
For example if the seating unit is too large to fit through the door.

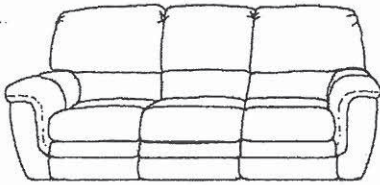

First remove and discard packing material and become familiar with all instructions below.

GENERAL
VIEW OF
SOFA UNIT
BOTTOM

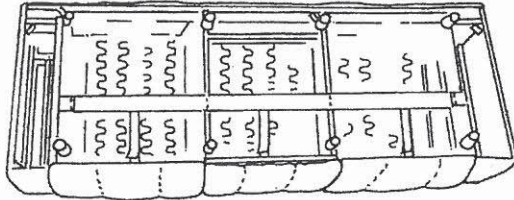

1 Tilt unit forward from rear until it rests on the ottoman/foot rest.

Note: It may be necessary for two people to accomplish this maneuver.

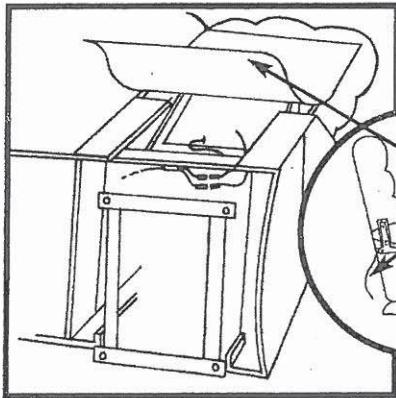

2 Loosen velcro from outside back of unit, and move it out of the way.

3 Locate electrical wiring and disconnect if applicable.

Note: The **correct** way to disconnect the electrical connectors is to grasp the connectors and pull apart.

ELECTRICAL
WIRING

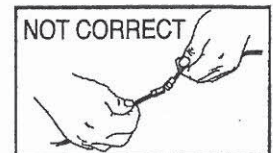
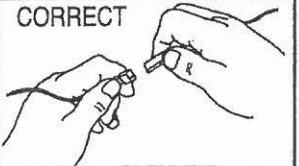
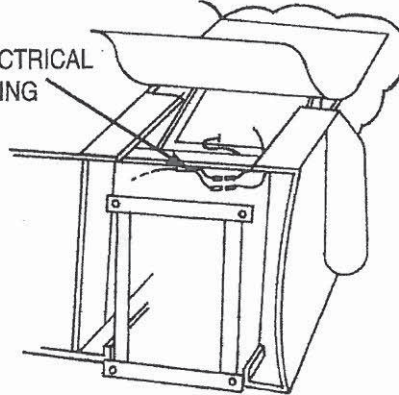

DO NOT PULL ON WIRES

4 Using a 7/16 wrench, remove bolts connecting the hardware to the back wing frame or console or both if required. Bolts and hardware are inside the back of the unit as noted below in diagram.

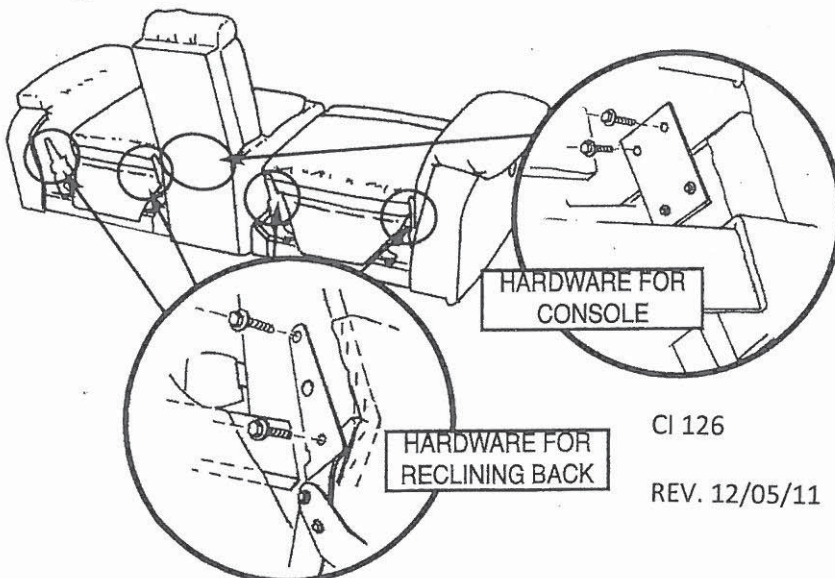

5 Reassemble the backs of the seating units.

Note: If the seating unit comes without a motor driven mechanism, it will have straps holding the ottomans in place. Before turning unit upright these straps need to be removed.

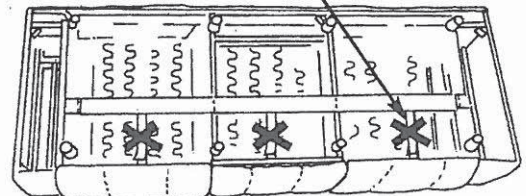

CI 126

REV. 12/05/11