

4225 - 01 / 4225BLK - 01 GABRIELLE OVAL DINING TABLE
Packed in 2 cartons

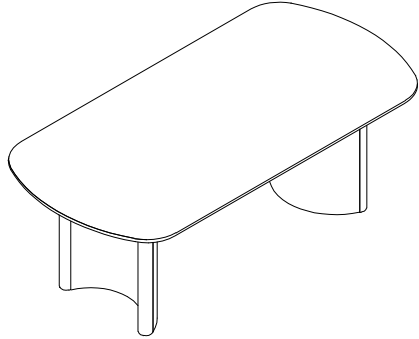

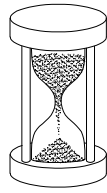



ASSEMBLY INSTRUCTIONS

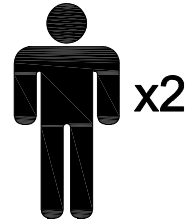

15 MIN



CARTON	ITEM	PART	HARDWARE	
1	4225-01T / 4225 BLK-01T	① TABLE TOP x 1 PC	④	M8 x 35 mm: 12 pcs 
			③	Ø8 x Ø13 x 1.2: 8 pcs 
			②	Ø8 x Ø19 x 2: 8 pcs 
			①	4mm x 50: 1 pc 
2	4225-01B / 4225 BLK-01B	② LEGS x 2 PCS		

STEP 1

Prepare the Table Top (1) by placing it upside - down on a flat, soft & clean surface. Locate the legs to be assembled.

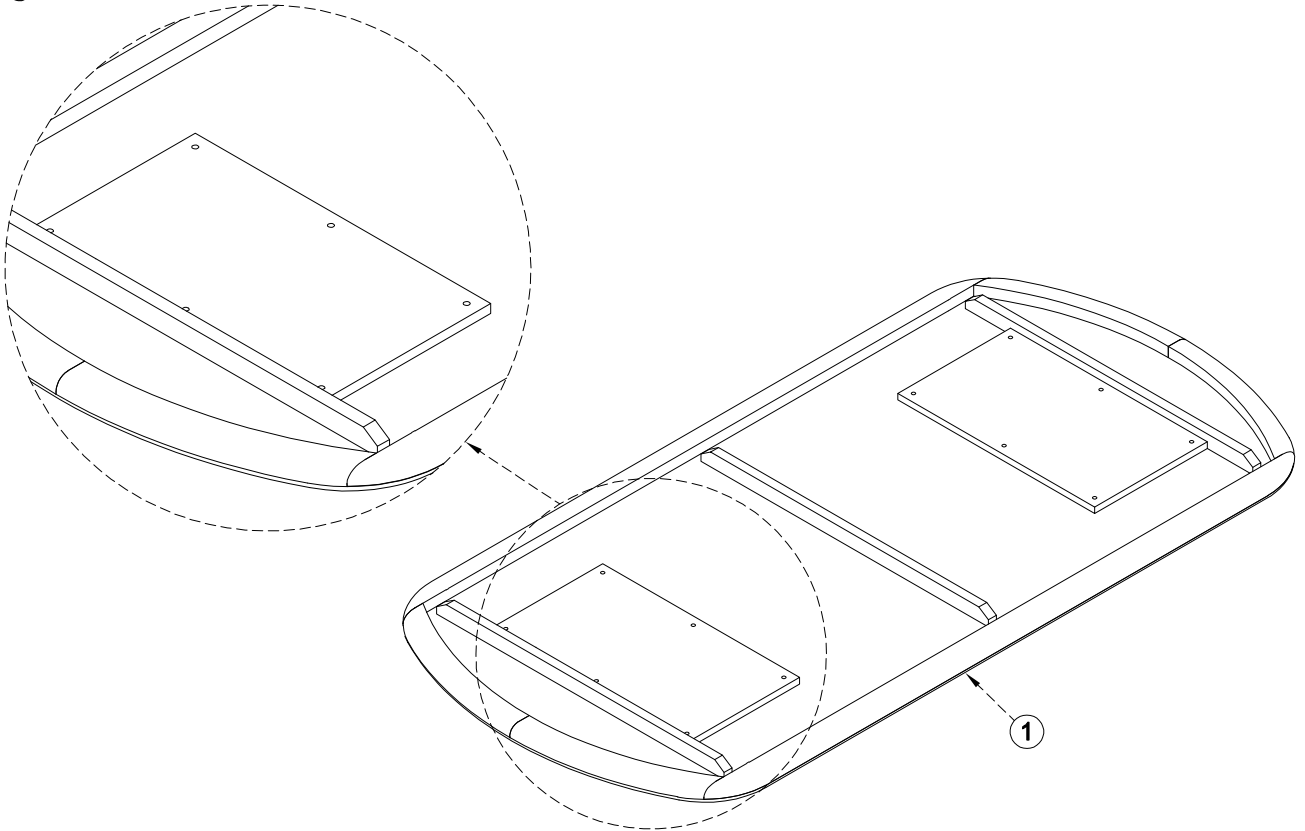





STEP 2

Assemble each table leg (2) by attaching it in connecting holes.

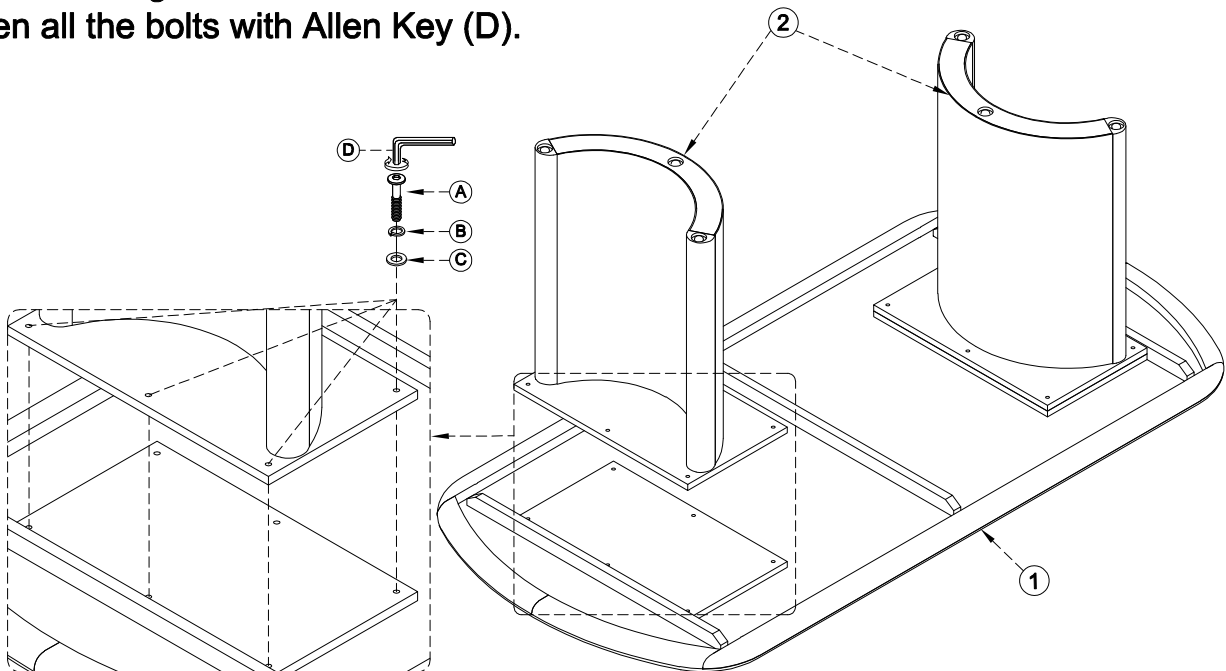
Align Bolt (A) fitted with a Spring Washer (B) & a Flat Washer (C) through the Connecting holes. See image below.

Tighten all the bolts with Allen Key (D).



A 	B 	C 	D 
M8 x 35 mm : 12 pcs.	Ø8 x Ø13 x 1.2 : 12 pcs.	Ø8 x Ø19 x 2 : 12 pcs.	4mm x 50 : 1 pc.

ASSEMBLY COMPLETED

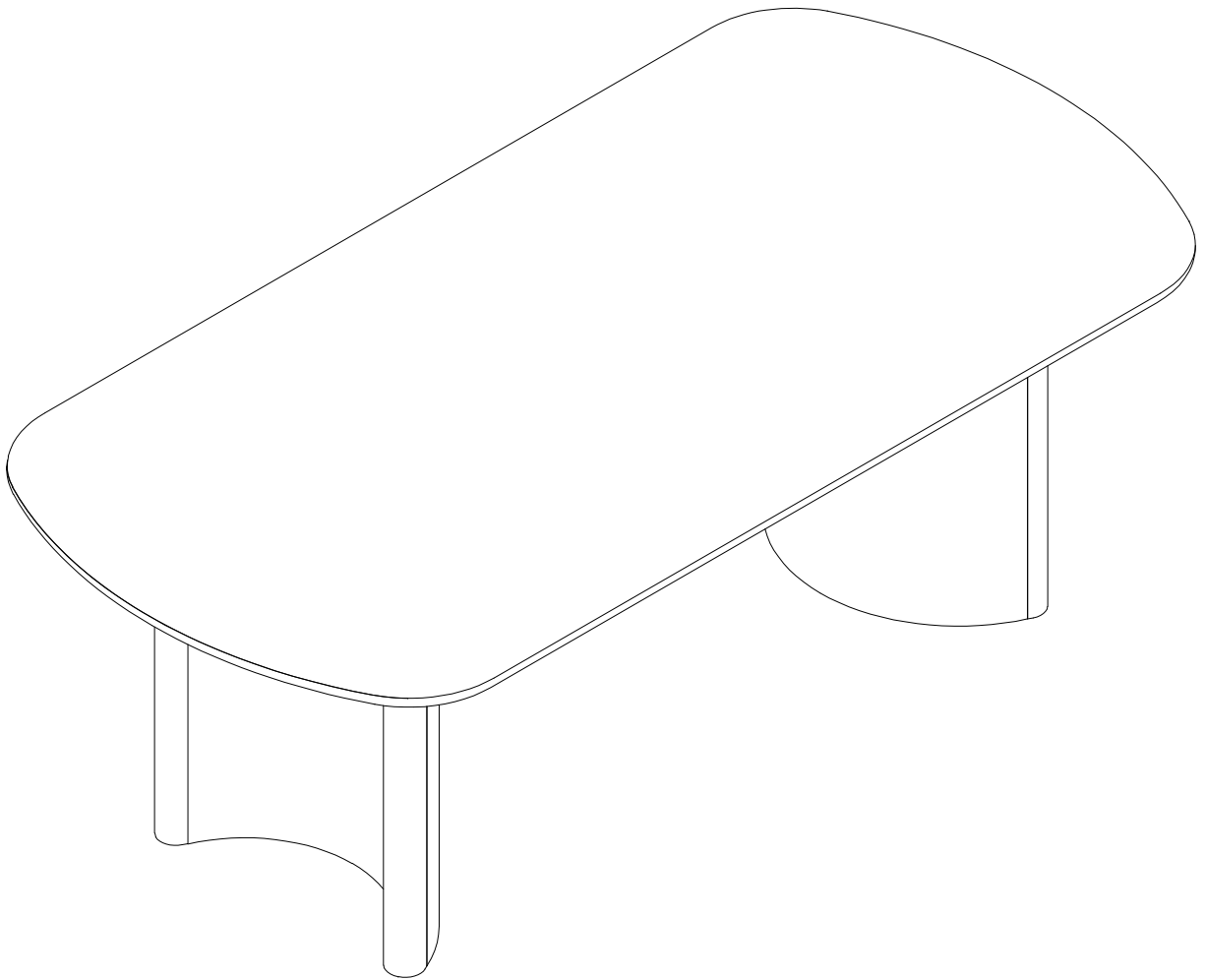

"Carefully reposition the Table Upright with the help of Two or more adults"