

DOUBLE EGG CHAIR

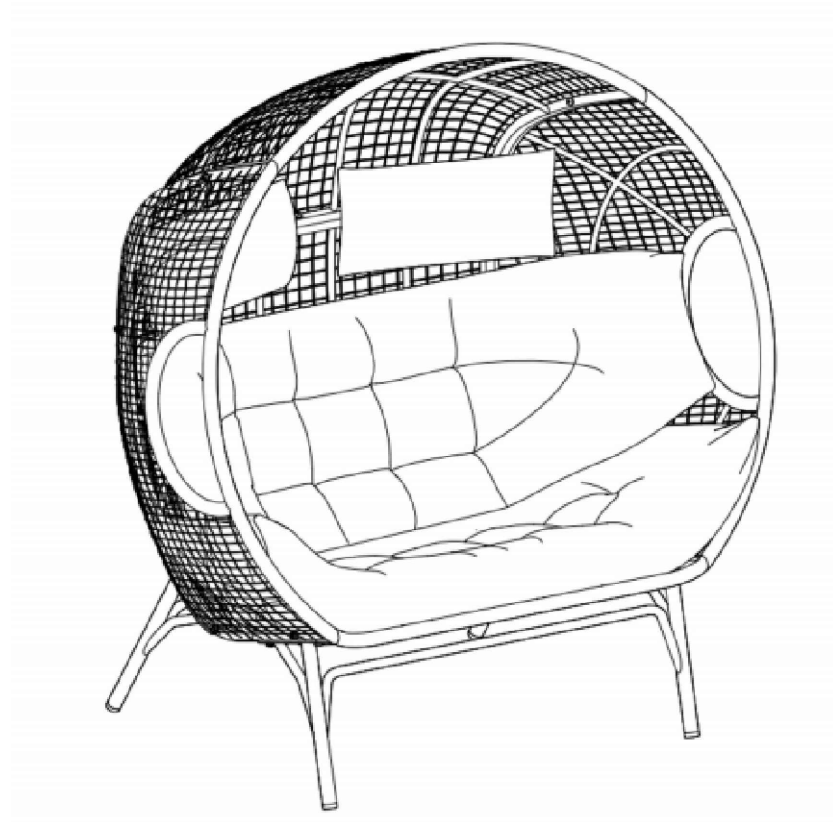









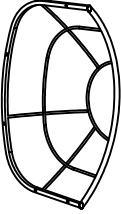
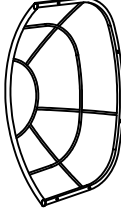
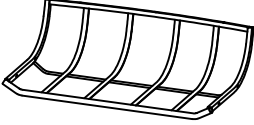
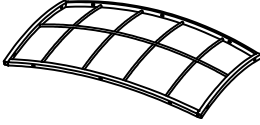
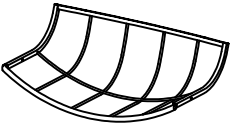

ATTENTION Section:

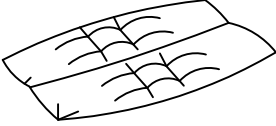
1. If you encounter any issues, such as missing accessories or damaged parts, please contact us immediately and include pictures

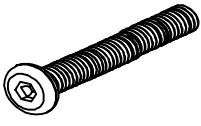
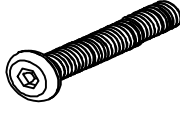
Assembly Instructions:

1. Assembly requires two people to complete.
2. For optimal assembly, we highly recommend using the provided Allen key.
If using a power tool, please set it to a low speed to prevent any damage
3. Do not fully tighten the screws until all screws are properly aligned with their holes.

PARTS LIST OF BOX A

<p>A</p>  <p>LEFT PLATE 1pc</p>	<p>B</p>  <p>RIGHT PLATE 1pc</p>	<p>C</p>  <p>SEAT PLATE 1pc</p>	<p>D</p>  <p>CENTRE PLATE 1pc</p>
<p>E</p>  <p>TOP PLATE 1pc</p>	<p>F</p>  <p>FRONT CHAIR LEGS 1pc</p>	<p>G</p>  <p>REAR CHAIR LEGS 1pc</p>	<p>H</p>  <p>SEAT CUSHION 1pc</p>
<p>I</p>  <p>NECK PILLOW 2pcs</p>	<p>①</p>  <p>M6*55 6pcs</p>	<p>②</p>  <p>M6*50 10pcs</p>	<p>④</p>  <p>M6*18 8pcs</p>
<p>⑤</p>  <p>M6 40pcs</p>	<p>⑥</p>  <p>M6 16pcs</p>	<p>⑦</p>  <p>M6 1pc</p>	<p>⑧</p>  <p>M6 1pc</p>

STEP 1

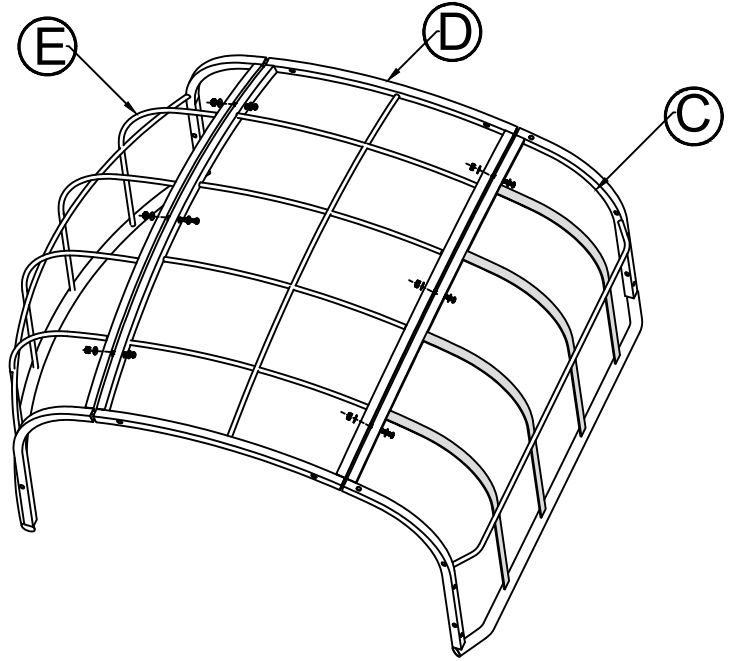
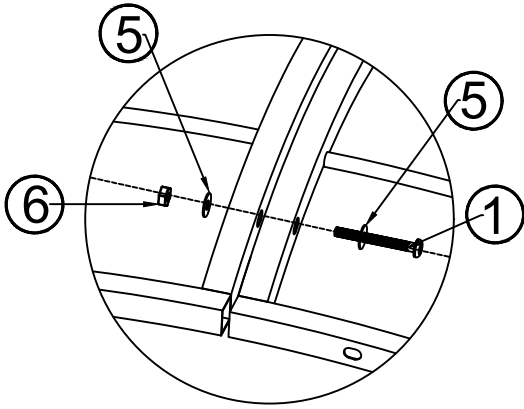

C*1pc	D*1pc	E*1pc	①*6pcs	⑤*12pcs	⑥*6pcs	⑦*1pc	⑧*1pc
			M6*55	M6	M6	ALLEN KEY M6	M6

STEP 2

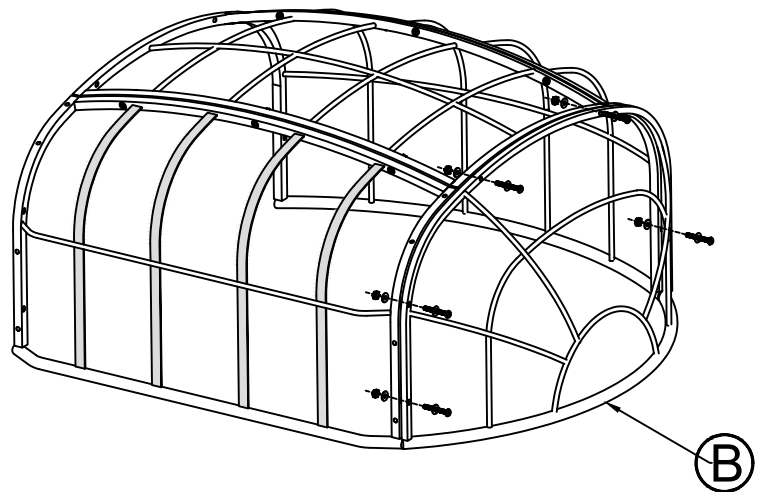
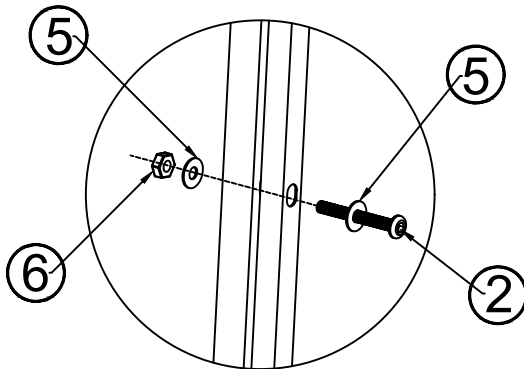

B*1pc	②*5pcs	⑤*10pcs	⑥*5pcs	⑦*1pc	⑧*1pc
	M6*50	M6	M6	ALLEN KEY M6	M6

Do not fully tighten all screws until assembly is completed.

STEP 3

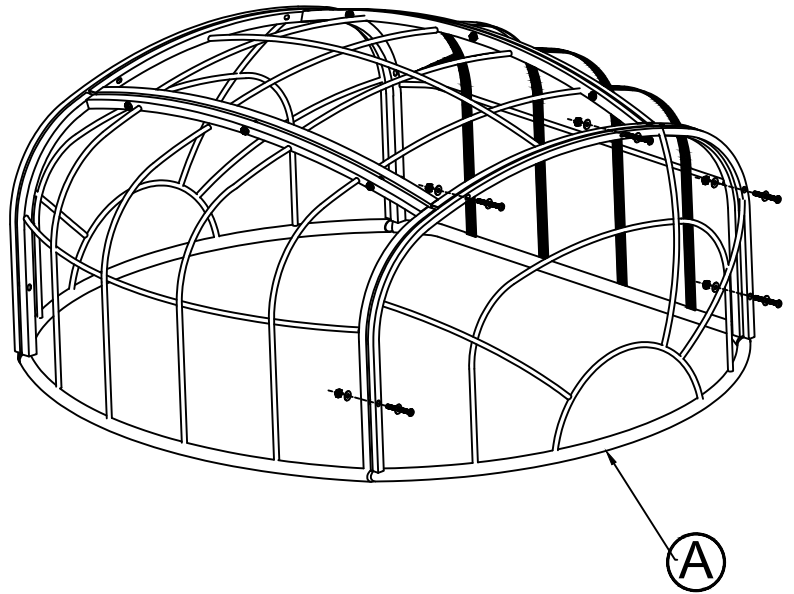
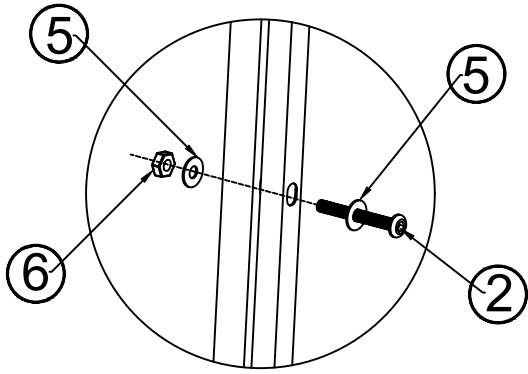

A*1pc	②*5pcs	⑤*10pcs	⑥*5pcs	⑦*1pc	⑧*1pc
	M6*50	M6	M6	ALLEN KEY M6	M6

STEP 4

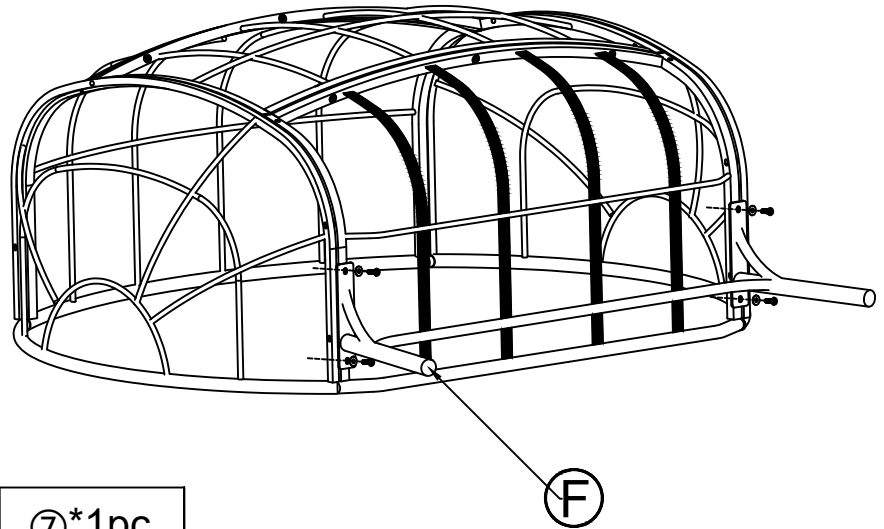
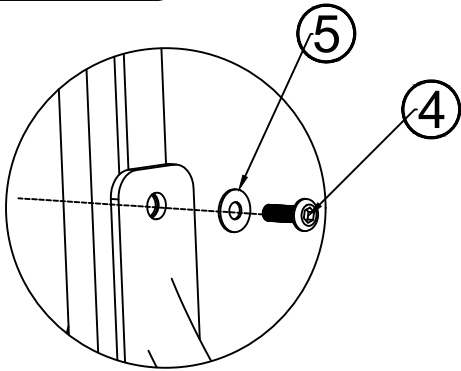

F*1pc	④*4pcs	⑤*4pcs	⑦*1pc
	M6*18	M6	ALLEN KEY M6

Do not fully tighten all screws until assembly is completed.

STEP 5

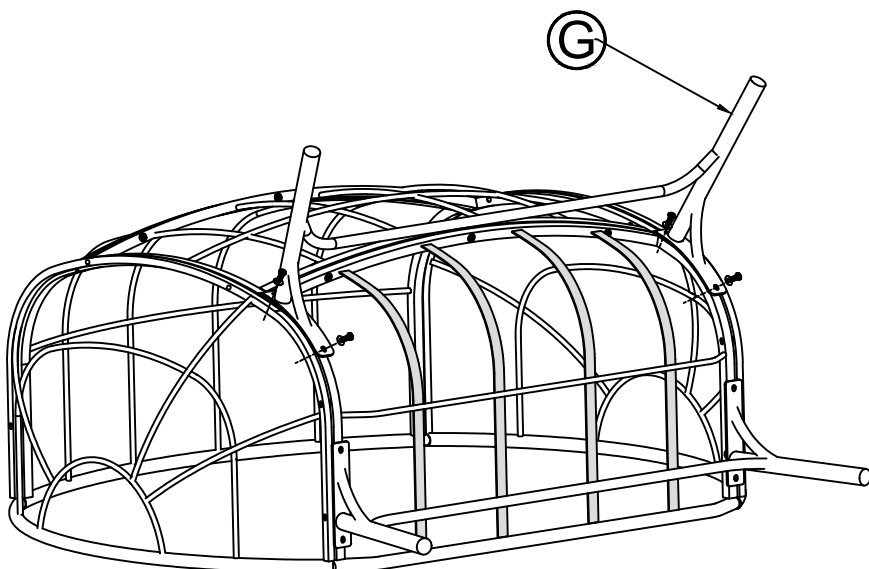
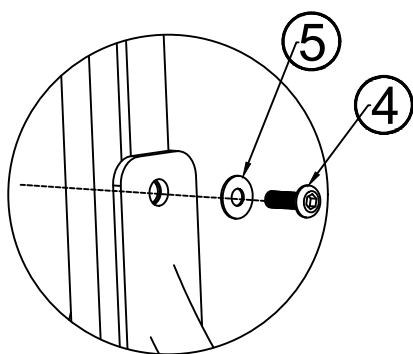

G*1pc

④*4pcs

⑤*4pcs

⑦*1pc



M6*18



M6



ALLEN KEY M6

STEP 6

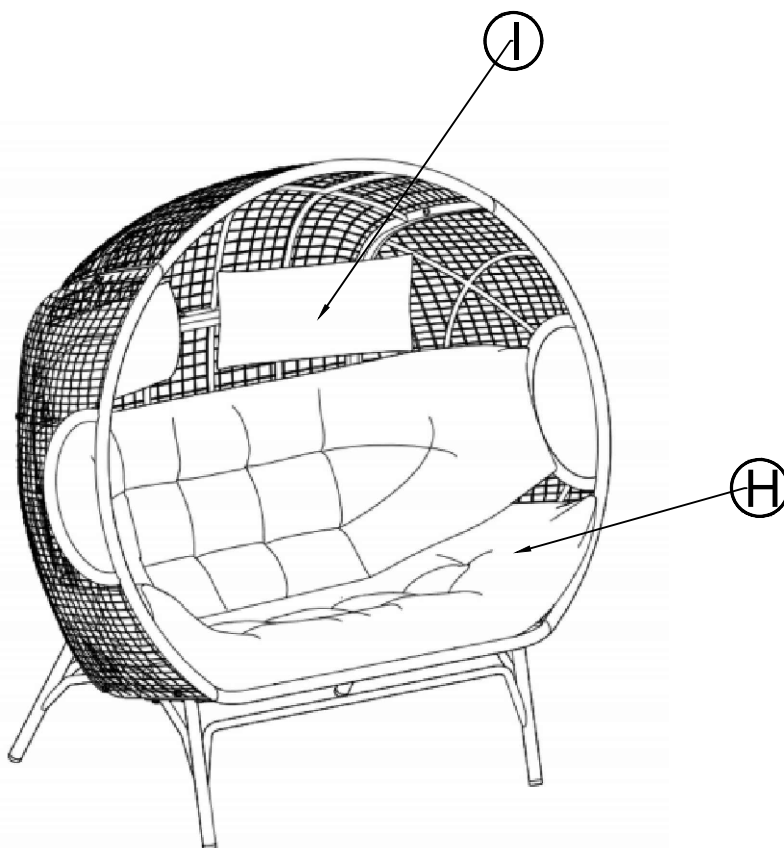

H*1pc

I*2pcs



Do not fully tighten all screws until assembly is completed.