

Assembly Instruction

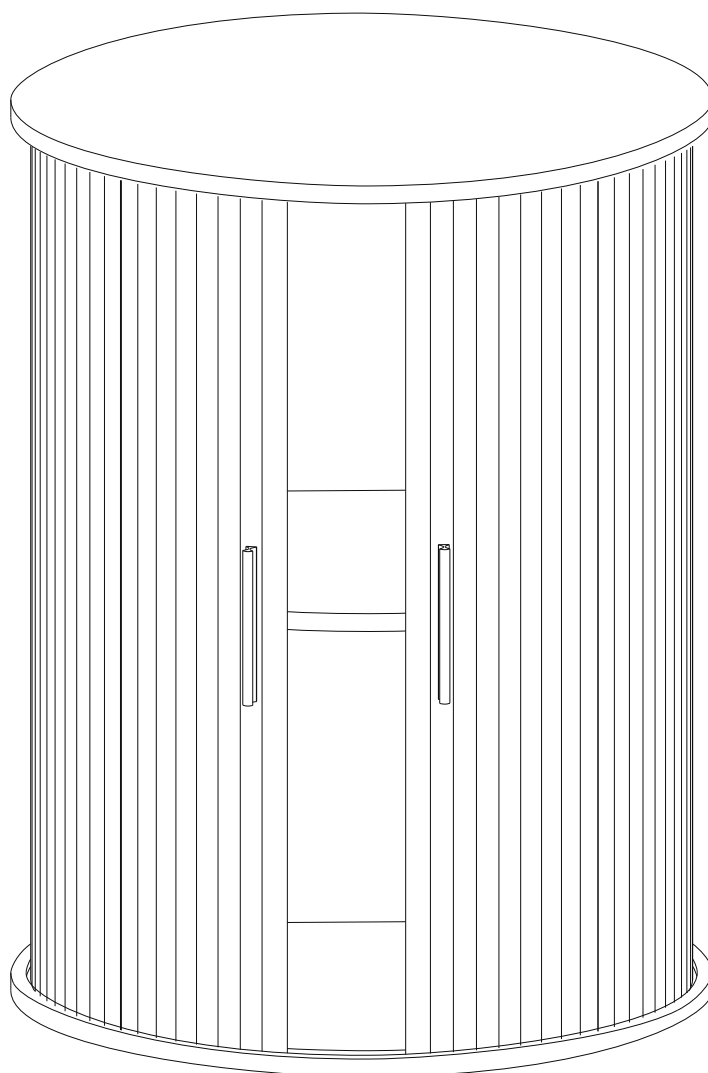



WARNING

Serious or fatal crushing injuries can occur from furniture tip-over. To help prevent tip-over.

- Place heaviest items in the lowest drawers.
- Do not set TVs or other heavy objects on the top of this product.
- Never allow children to climb or hang on drawer, door, or shelves.
- Never open more than one drawer at a time.

MAINTENANCE TIPS



Avoid liquid spraying or infiltrating on the product surface.



Never use chemical cleaning products. They will damage the finish.

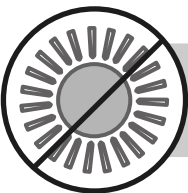

To avoid dulling of finish, do not place furniture in direct sunlight.

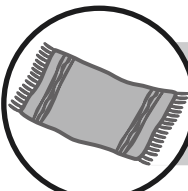

Do not put plastic or rubber rings under appliances. Use cloth or felt protectors.



To clean, use a soft or slightly damp cloth, and wipe with a clean and dry cloth.



Sicherheitshinweise

Schwere oder tödliche Quetschverletzungen können durch Umkippen von Möbeln auftreten. Um ein Umkippen zu verhindern.

- Lege die schwersten Gegenstände in die untersten Schubladen.
- Legen Sie keine Überlastungsobjekte auf die Oberseite dieses Produkts.
- Lassen Sie Kinder niemals klettern oder an Schubladen, Tür oder Regale hängen.
- Öffnen Sie niemals mehr als eine Schublade gleichzeitig.

WARTUNGSTIPPE



Vermeiden Sie das Versprühen oder Eindringen von Flüssigkeiten auf die Produktoberfläche.



Verwenden Sie keine chemischen Reinigungsmittel. Sie können das Produkt beschädigen und müssen nach Abschluss der Reinigung nur mit einem leicht feuchten Tuch trocken abgewischt werden.

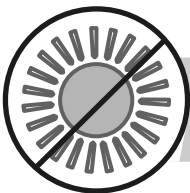

Um ein stumpfes Finish zu vermeiden, stellen Sie Furniture nicht in direktes Sonnenlicht.

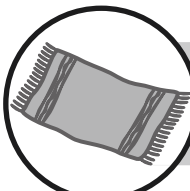

Legen Sie keine Kunststoff- oder Gummiringe unter Geräte. Verwenden Sie ein Tuch aus Filzschutz.



Verwenden Sie ein weiches oder leicht feuchtes Tuch, wischen Sie es mit einem sauberen, trockenen Tuch ab.

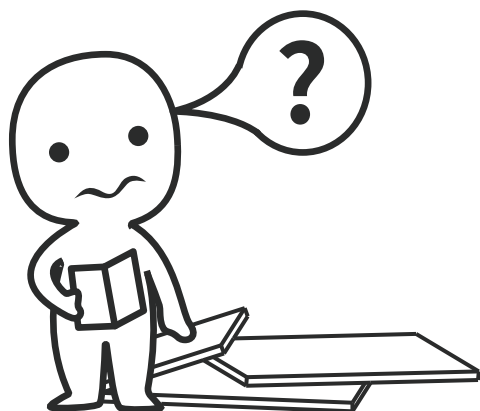
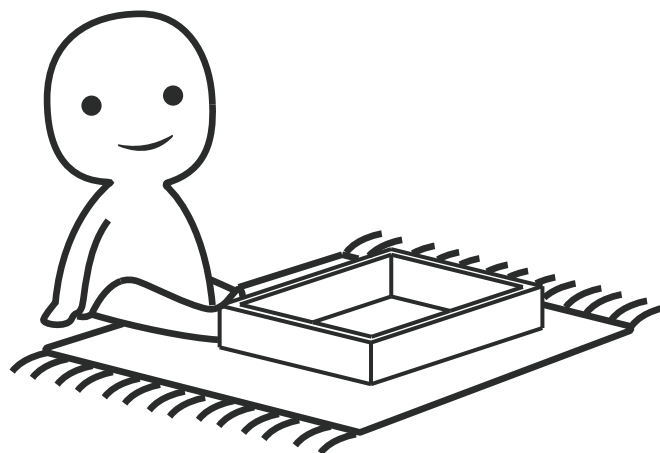
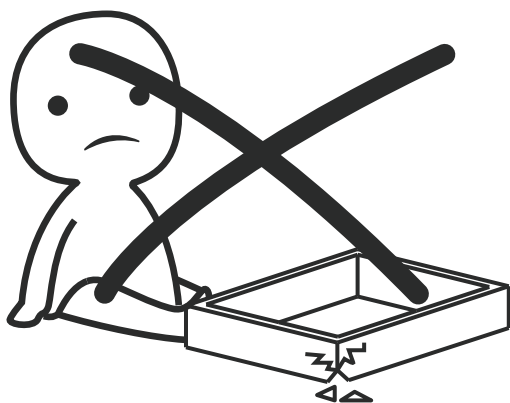
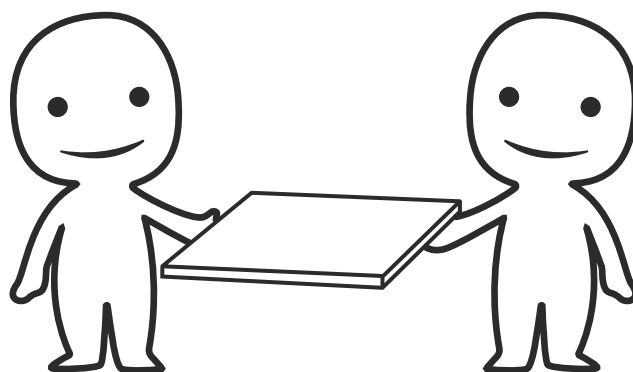
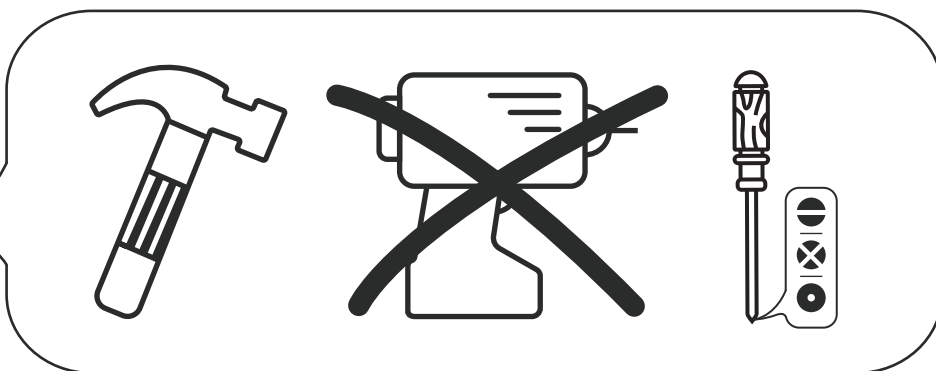
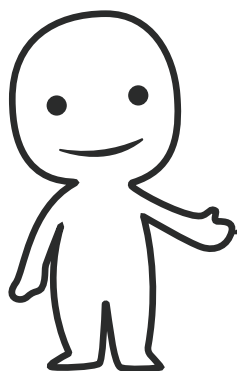

DE

Wichtige Information

- Sorgfältig und aufmerksam lesen
- Diese Information aufbewahren

GB

Safety information

- Important information
- Please read closely and carefully
- Save this information

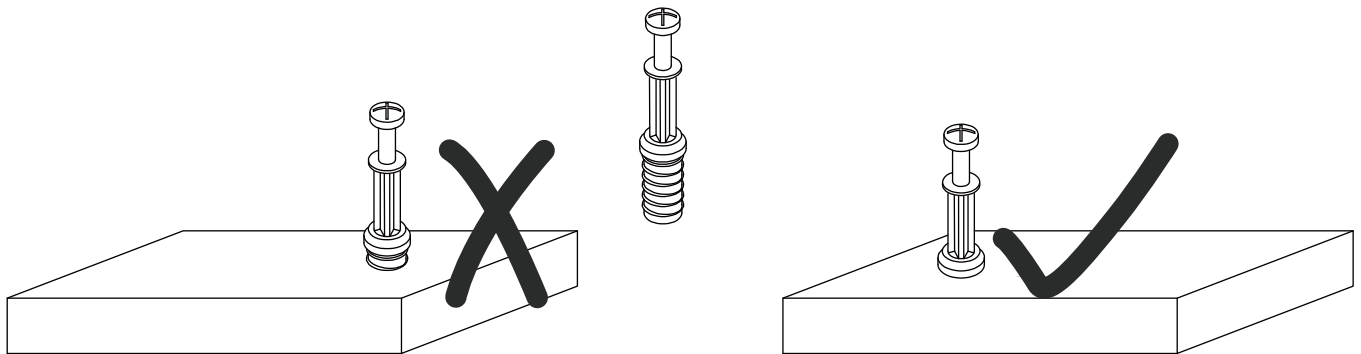

CAM LOCK

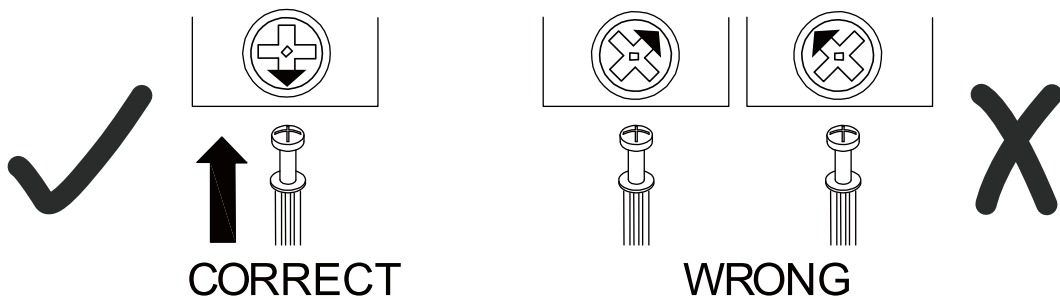

Nut should be in the centre of the cam lock when the two panels are joined.
Cam lock should be inserted before nut.

Wenn die beiden Platten verbunden sind, sollte die Mutter in der Mitte des Nockenschlosses sein.

Die Nockenverriegelung sollte vor der Mutter eingeführt werden.

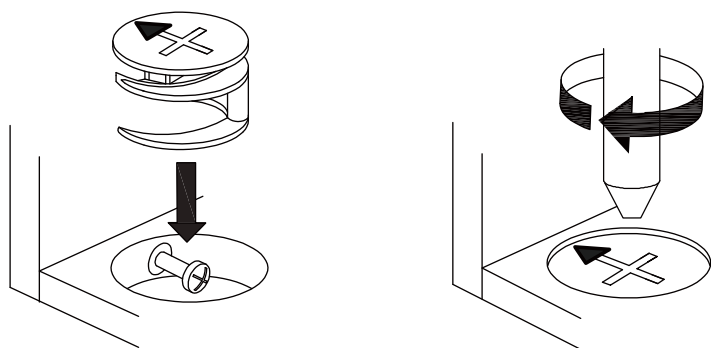

Parts List/Teileliste

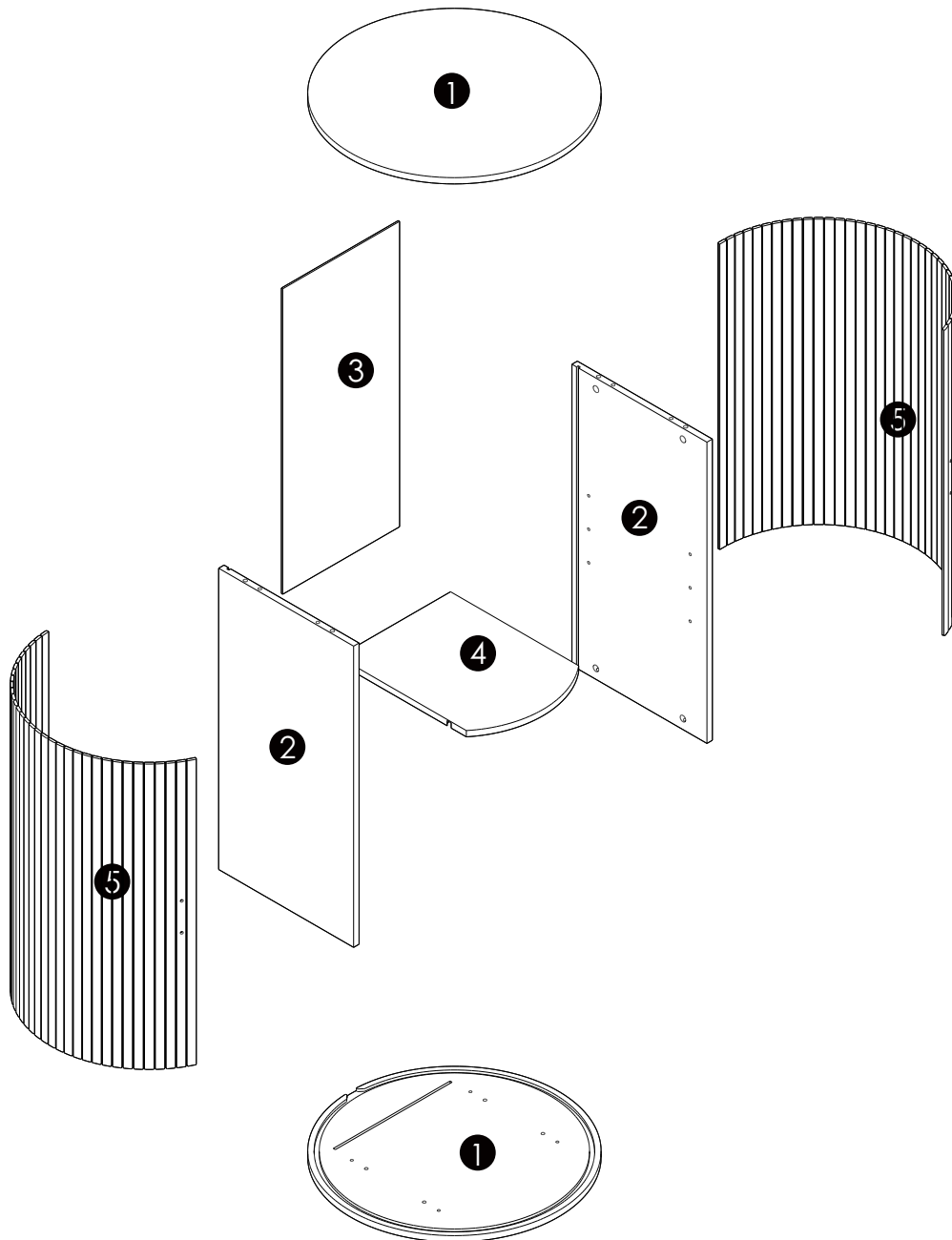

PARTS LIST

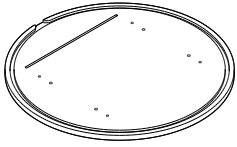
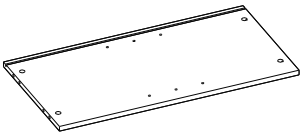
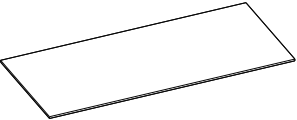
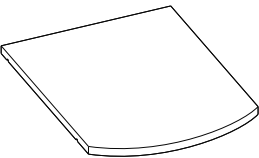
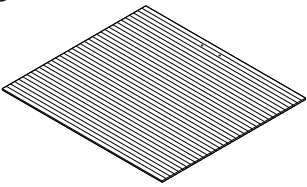

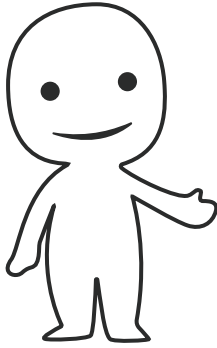



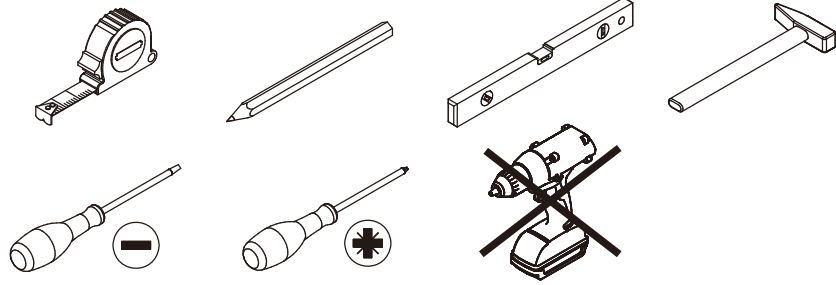

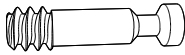

<p>1 x2 PC</p>  <p>458x458x12</p>			
<p>2 x2 PC</p>  <p>576x298x12</p>			
<p>3 x1 PC</p>  <p>584x258x3</p>			
<p>4 x1 PC</p>  <p>327x248x12</p>			
<p>5 x2 PC</p>  <p>525x584x5</p>			

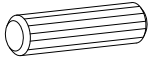

Please prepare the following tools

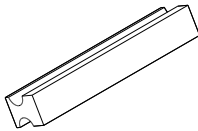



When installing, please carefully confirm whether each screw corresponds to the manual, accessories with similar shapes can be distinguished by size

<p>A x8 PC</p>  <p>6x28</p>	<p>B x8 PC</p>  <p>12x10</p>	<p>C x8 PC</p>  <p>6x30</p>	<p>D x8 PC</p>  <p>3.5x12</p>
<p>E x8 PC</p>  <p>25x3</p>	<p>F x4 PC</p>  <p>4x12</p>	<p>G x2 PC</p>  <p>12x10</p>	<p>H x4 PC</p>  <p>6x28</p>
<p>I x4 PC</p>  <p>6x30</p>	<p>J x4 PC</p>  <p>12x10</p>		

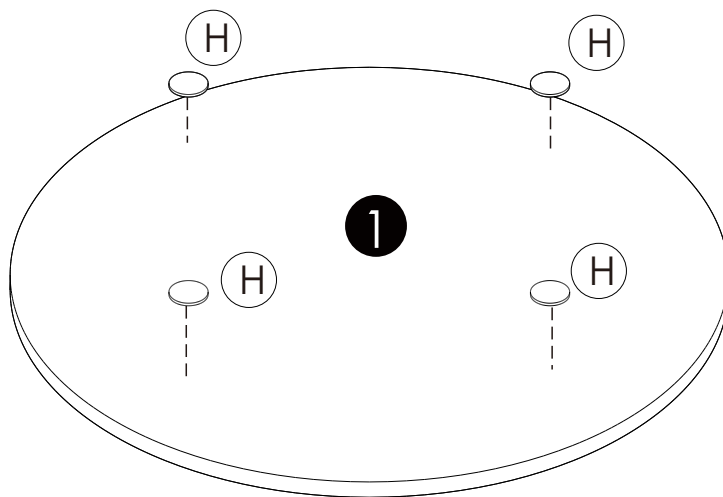
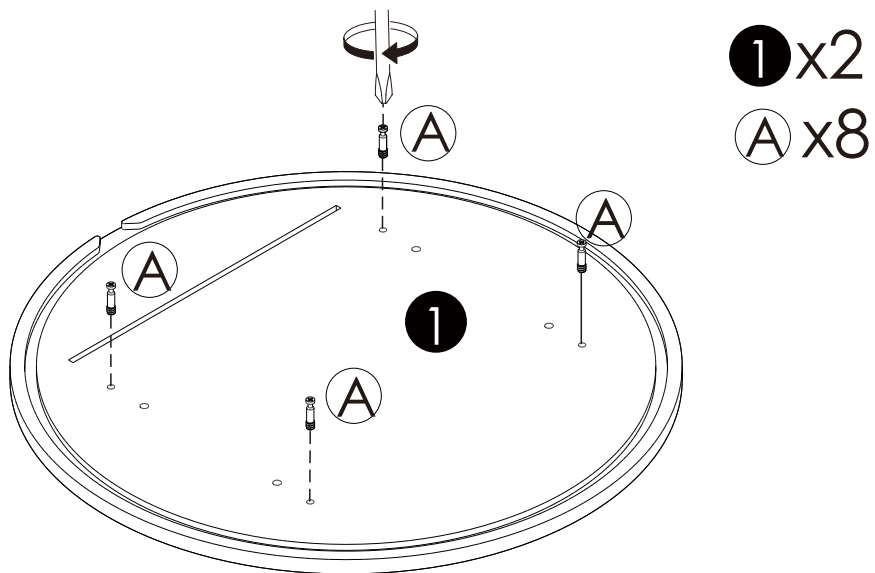
Step 1





A		x8
H		x4

Step2

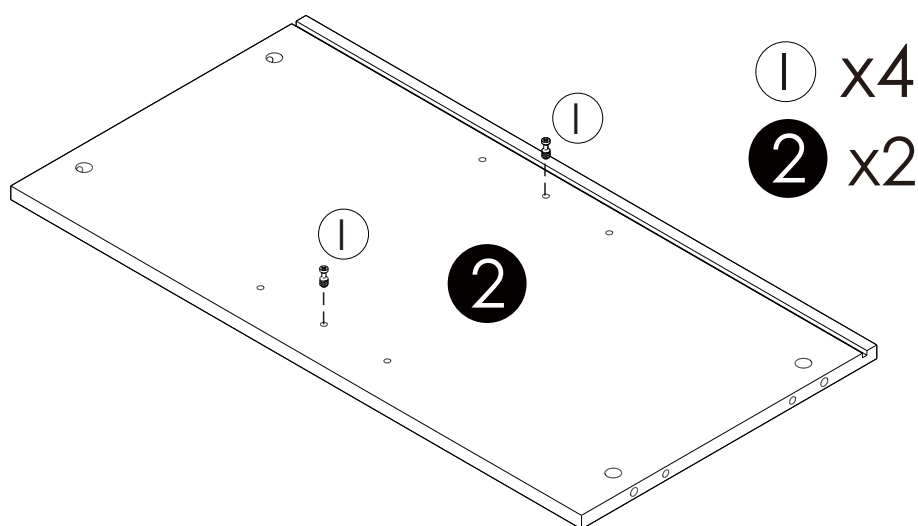
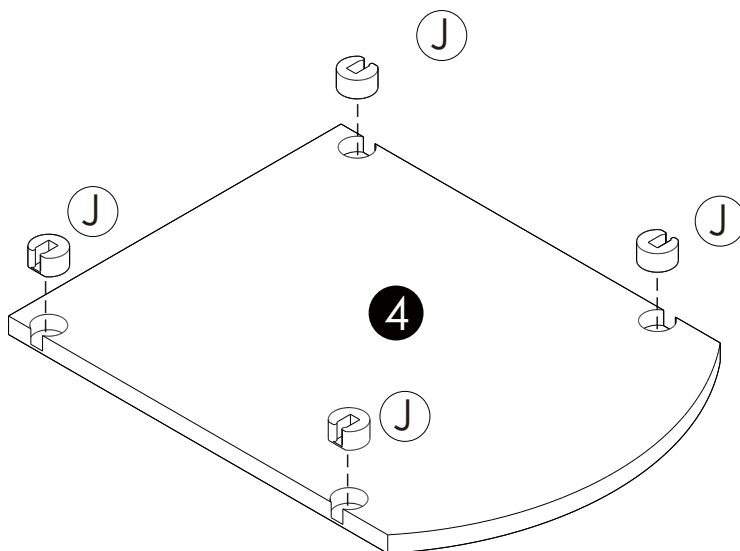
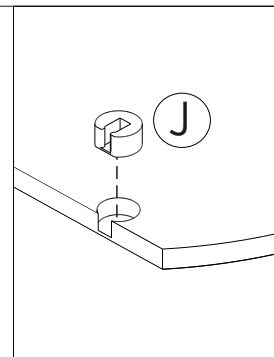

The coupling bolts should go into place when tapped lightly with a hammer



I		x4
J		x4

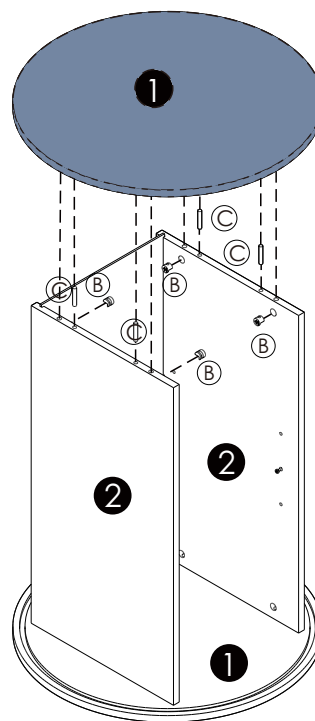
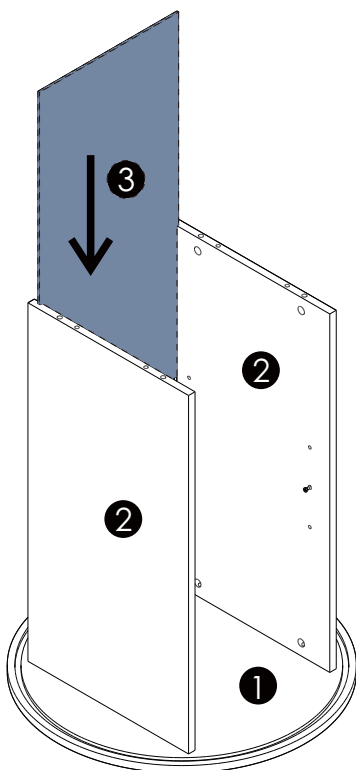
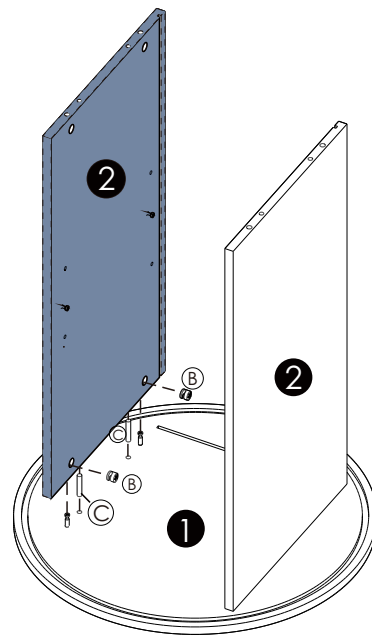
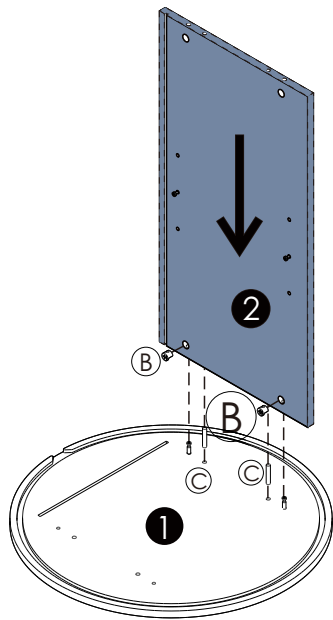

Step3



B		x8
C		x8

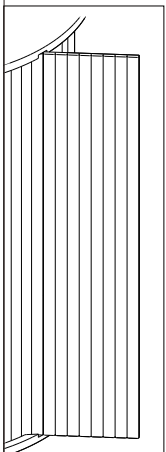
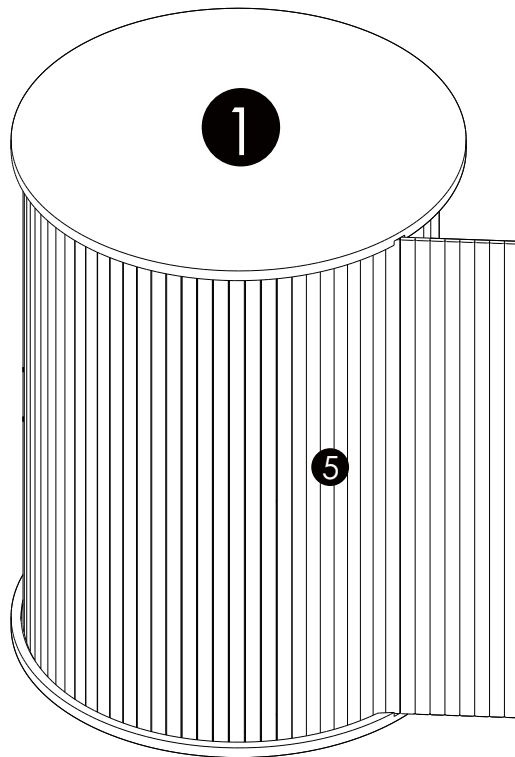
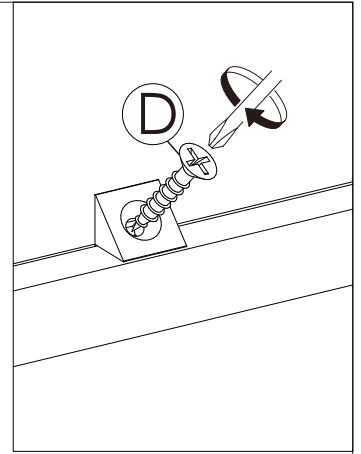
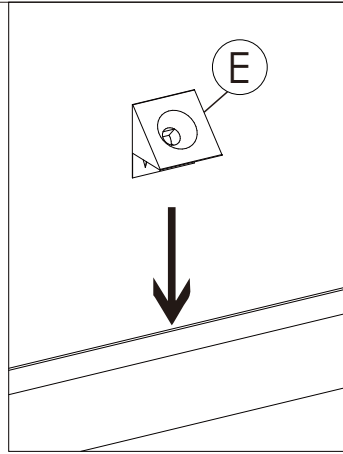
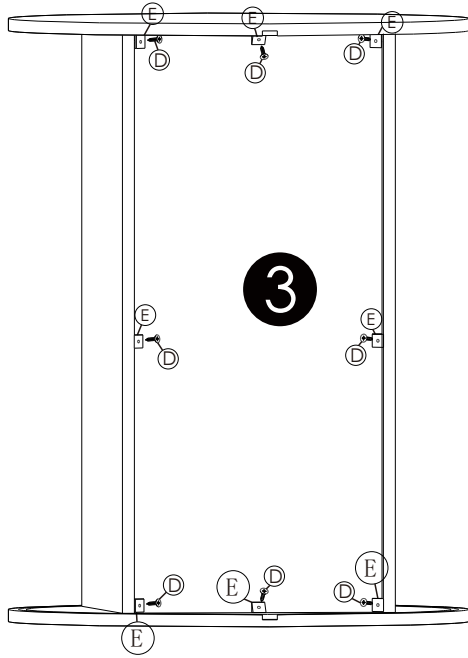

Step 4

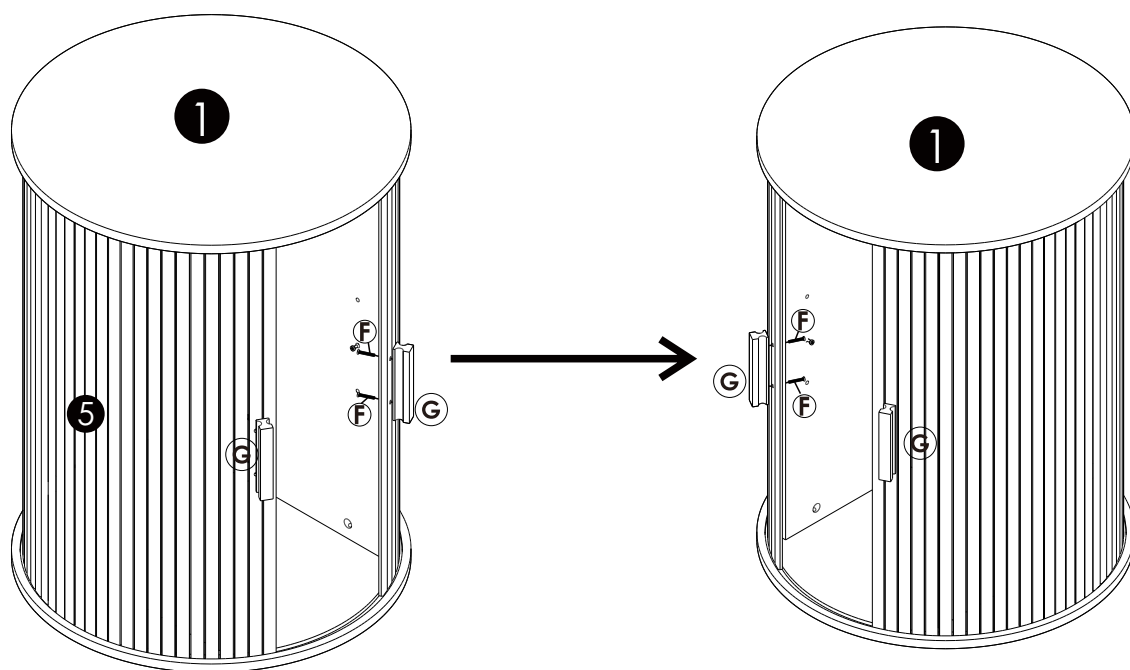
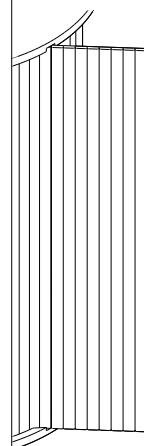
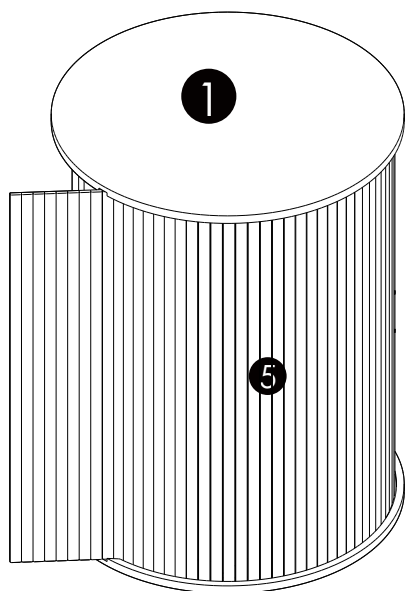

D		x8
E		x8

Step5



F		x4
G		x2

Step 6

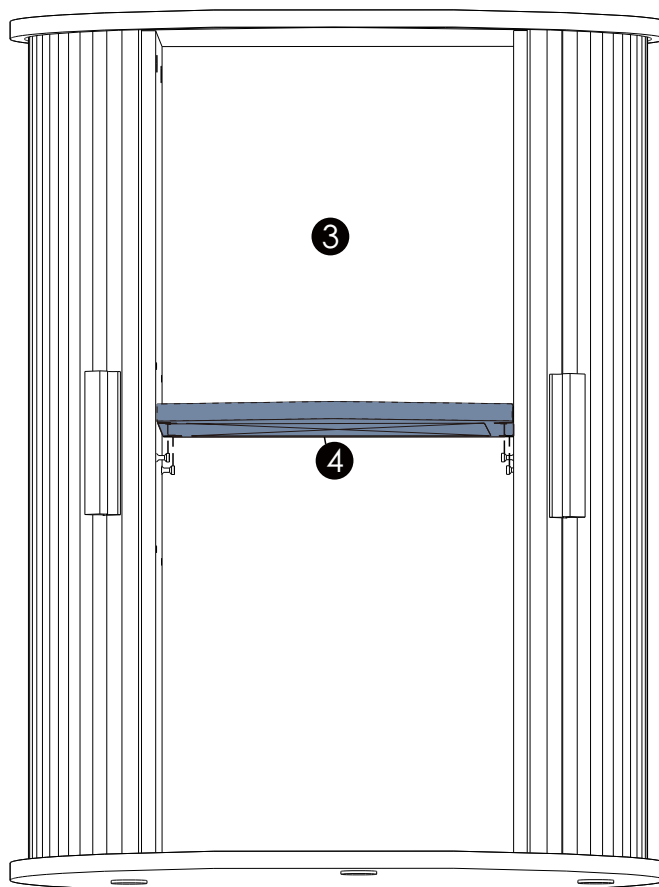

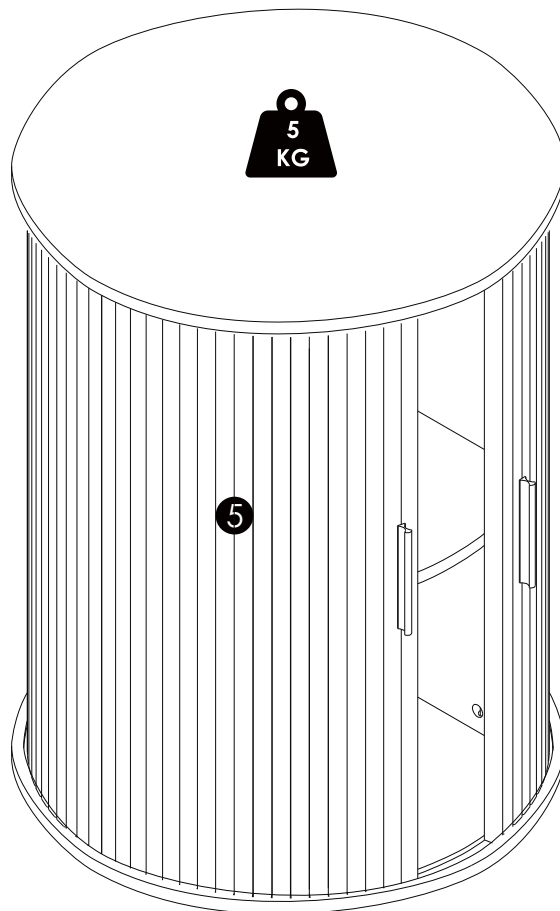

**Serious or fatal crushing injuries can occur from furniture tip-over.
To further reduce the risk of serious injury and death from tip-overs:**

Schwere oder tödliche Quetschverletzungen können durch Umkippen von Möbeln auftreten.

Um das Risiko schwerer Verletzungen und Todesfälle durch Umkippungen weiter zu reduzieren.

DE Sicherheitshinweise

- Wichtige Information
- Sorgfältig und aufmerksam lesen
- Diese Information aufbewahren



WICHTIG. Der Aufbau des Möbels muss zwingend nach Aufbauanleitung und durch eine fachkundige Person erfolgen. Sämtliche Elektro- und Sanitärinstallationen sind ausschließlich von autorisiertem Fachpersonal durchzuführen.

Um zu verhindern, dass ein Möbel umkippt, muss es fest an der Wand verankert werden. Eine fehlerhafte Montage bzw. fehlende Wandbefestigung kann zu Funktionsbeeinträchtigungen, Beschädigungen und/oder schweren Verletzungen führen.

Wegen der großen Vielfalt an Wänden und Wandmaterialien haben wir kein Befestigungsmaterial beigelegt. Bitte erkundigen Sie sich im Fachhandel nach geeignetem Befestigungsmaterial entsprechend Ihren baulichen Gegebenheiten. Sie sind für die Befestigung am Mauerwerk und den dort eingesetzten Materialien selbst verantwortlich.

Halten Sie die in der Montageanleitung angegebenen maximalen Gewichtsangaben ein. Beschlagbeutel, Beschlagteile und Verpackungsmaterial sind von Säuglingen und Kindern fernzuhalten, da verschluckbare Kleinteile enthalten sind und Erstickengefahr droht.

Werden Bedienungs-, Betriebs- oder Montageanweisungen nicht befolgt, Bauteile ausgewechselt, Änderungen an den Produkten vorgenommen oder Verbrauchsmaterialien verwendet, die nicht den Originalteilen entsprechen, so entfallen jegliche Haftungsansprüche und Gewährleistung. GERMANIA haftet nicht für Personen- oder Sachschäden, die auf eine unsachgemäße Montage bzw. nicht erfolgte Wandbefestigung zurückzuführen sind. Bei Überlastungen, die durch Menschen, spielende Kinder oder sonstige Einwirkungen entstehen, übernehmen wir als Hersteller keine Haftung.

Fragen zu Produkten oder Dienstleistungen
24 Stunden online Email : feedbackstation@163.com

GB Safety information

- Important information
- Please read closely and carefully
- Save this information



IMPORTANT. It is imperative that the furniture be installed according to instructions by someone properly qualified to complete the task. Installation of electrical or plumbing fixtures should only be performed by trained professionals.

The furniture must be anchored to the wall to prevent it from tipping over. Improper installation or failure to use wall fasteners can prevent the item from functioning properly and may cause damage and/or severe injury.

Wall fasteners are not included because of the large variety of walls and wall materials. Please ask a specialized dealer for wall fasteners appropriate to your specific needs. You are responsible for anchoring the items to the wall and for the materials used for that purpose.

Please observe the maximum load capacity as specified in the assembly instructions. Keep the bag containing the fittings, the fittings themselves and other packaging material out of reach of babies and children. The small parts can be swallowed and therefore pose a choking hazard.

Failure to follow handling, operation or assembly instructions, exchanging components, making changes to the product or using materials which differ from the original parts will result in voiding all liability claims and warranties. GERMANIA accepts no liability for personal or material damage due to improper installation or failure to properly anchor the item to the wall. We assume no liability as manufacturer for excessive loads placed on a unit by individuals, playing children or other causes.