

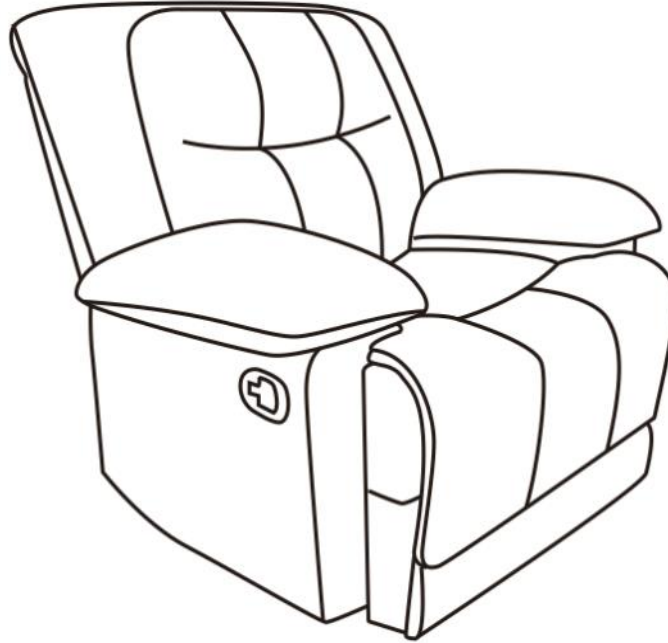

# Assembly Instructions

Caution: You must read this before you proceed

## Glider Recliner



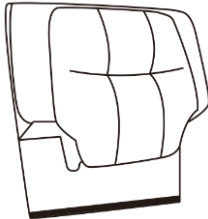
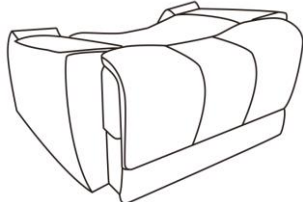



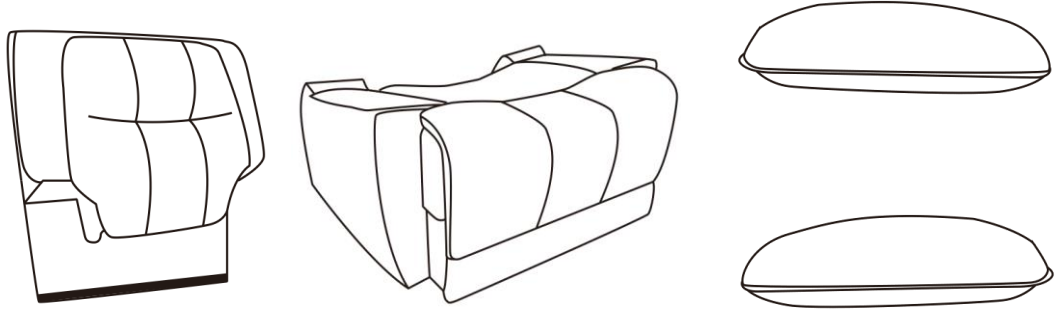

### Part List

Label	Picture	Description	QTY
A		Chair Backrest	1
B		Chair Base with Footrest	1
C		Left Armrest (with Zipper)	1

D		Right Armrest (with Zipper)	1
---	---	--------------------------------	---

## Assembly Preparation

Before Beginning Assembly:			
-------------------------------	--	--	--

    	<ul style="list-style-type: none"> <li>• Read instructions, cover to cover-</li> <li>• Have 2 adults on hand for assembly-</li> <li>• Do not assemble on flooring or carpet-</li> <li>• Assemble on a clean non-marring surface (packing foam)-</li> <li>• Save all packaging until finished-</li> </ul>
--	--

# Assembly Steps

## Overview

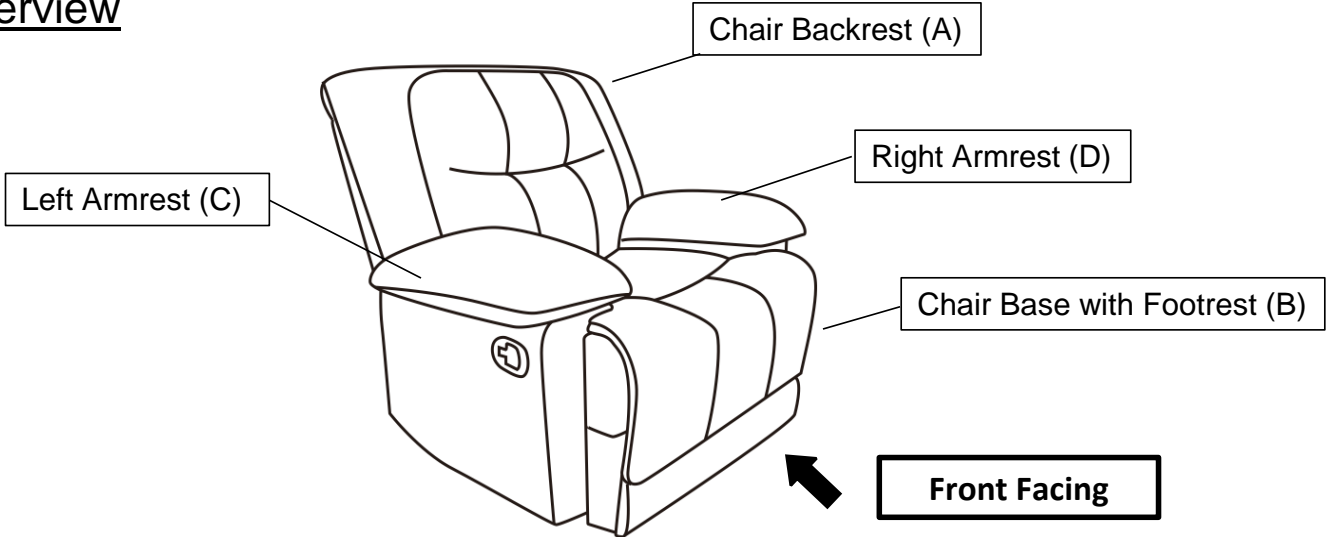

This Glider Recliner has multiple parts and may require up to some 30 minutes to assemble. To give you an overview of the Glider Recliner parts, the above picture is to help you put the various parts into perspective. Please read through the instructions below to familiarise yourself with the parts and steps before assembly.

## Step 1

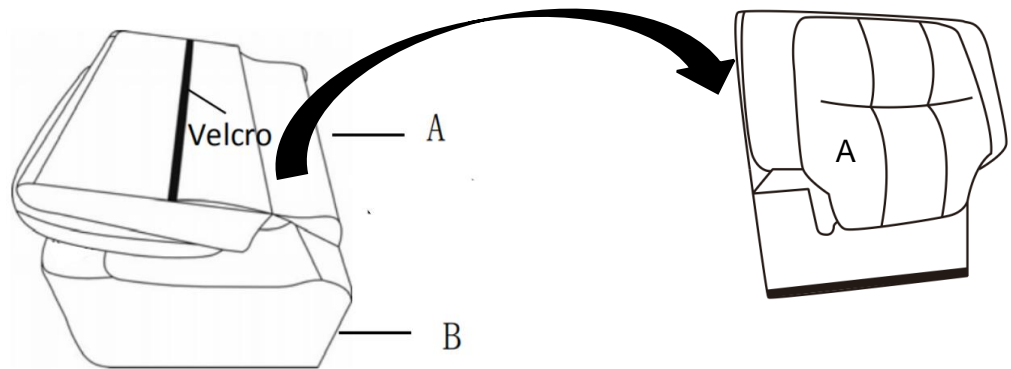

Take out the Chair Backrest(A) from the Chair Base with Footrest(B).

## Step 2

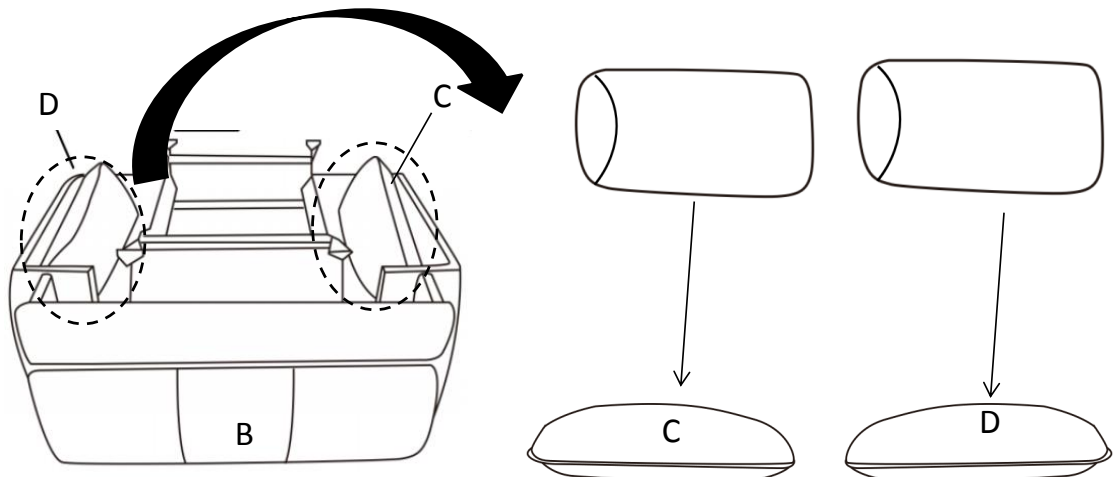

Take out the non-woven bags with the Left Armrest(C) and Right Armrest(D) inside from the bottom of the arms.

Then take the Armrests out of the non-woven bags.

### Step 3

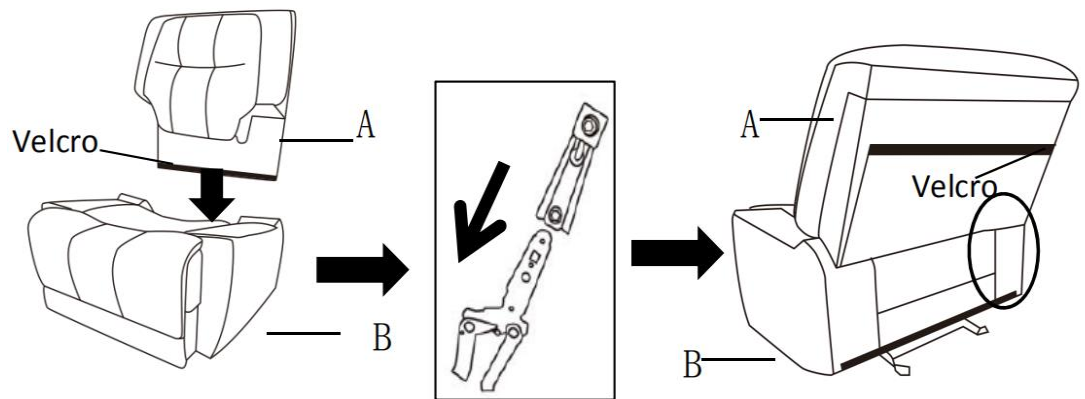

With assistance from your adult partner, hold up the Chair Backrest(A) while standing behind the Chair Base with Footrest(B).

Insert the small metal arms on the sides of the Chair Backrest(A) into the prefabricated slide lock gadgets on the Chair Base with Footrest(B) as shown above.

Firmly but gently, push the Chair Backrest(A) downwards until the Backrest(A) is fully slotted and locked into position.

### Step 4

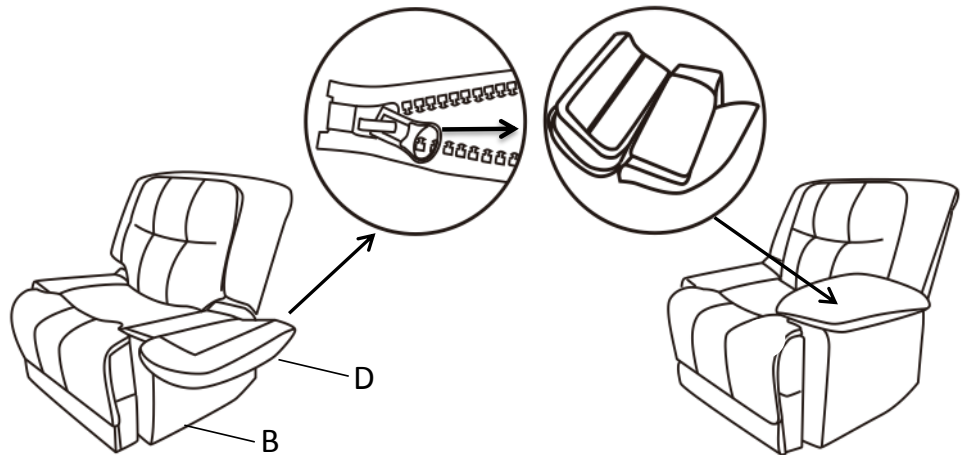

Attach the Right Armrest(D) to the right arm of Chair Base with Footrest(B) using zipper.

### Step 5

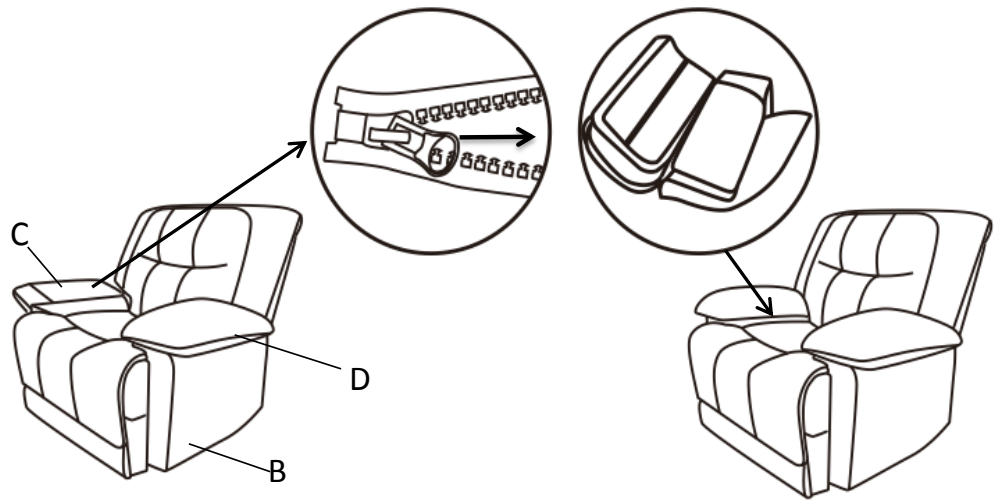

Attach the Left Armrest(C) to the left arm of Chair Base with Footrest(B) using zipper.

### Step 6

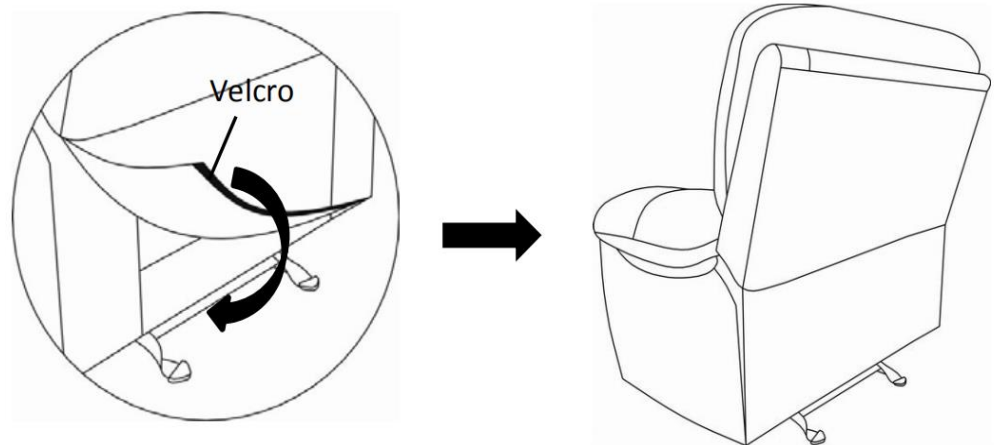

Smooth down the fabric flap on the Chair Backrest(A).

Run your hands down both sides of the flap, from top to bottom, allowing the velcro tape to adhere to the flap under the seat of the chair.

### Step 7

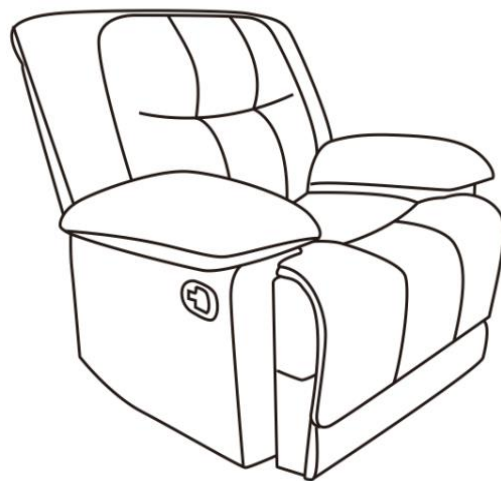

Make sure all parts are connected and securely locked into position.

Your Glider Recliner is ready for use.

**This Glider Recliner can only be used on a flat, level surface.**

# Disassembly Instructions

## Step 8

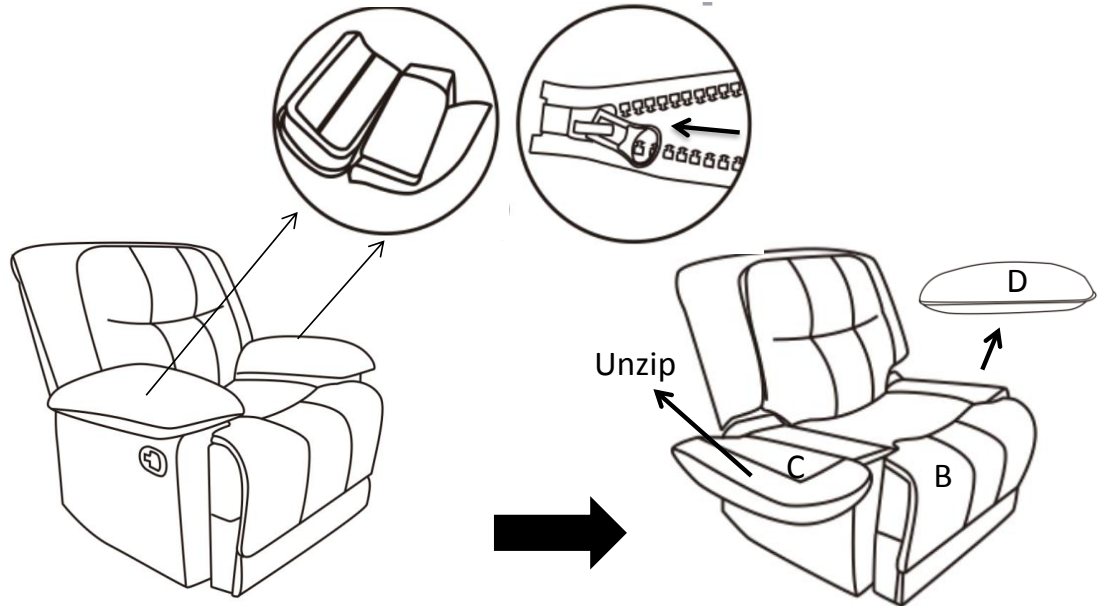

Unzip the Left Armrest(C) and Right Armrest(D) off the Chair Base with Footrest(B)

## Step 9

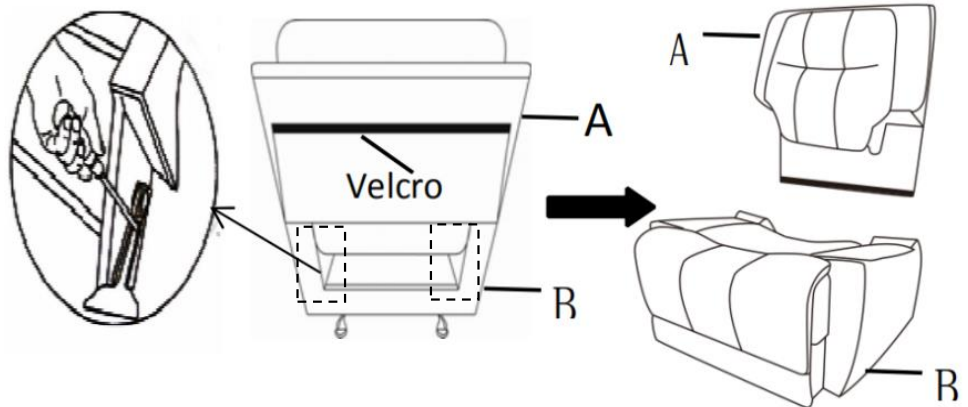

### To Disassemble Recliner:

Open the flap on the Chair Backrest(A), use a screwdriver(Don't use fingers) pressing outward on the metal ear on the preattached Metal Bracket on one side of the Chair Base(B)

With assistance of you adult partner to keep the Chair Base(B) in place,pull out the Chair Backrest(A) upward at the same time,repeat the same step for another side.

## Warning

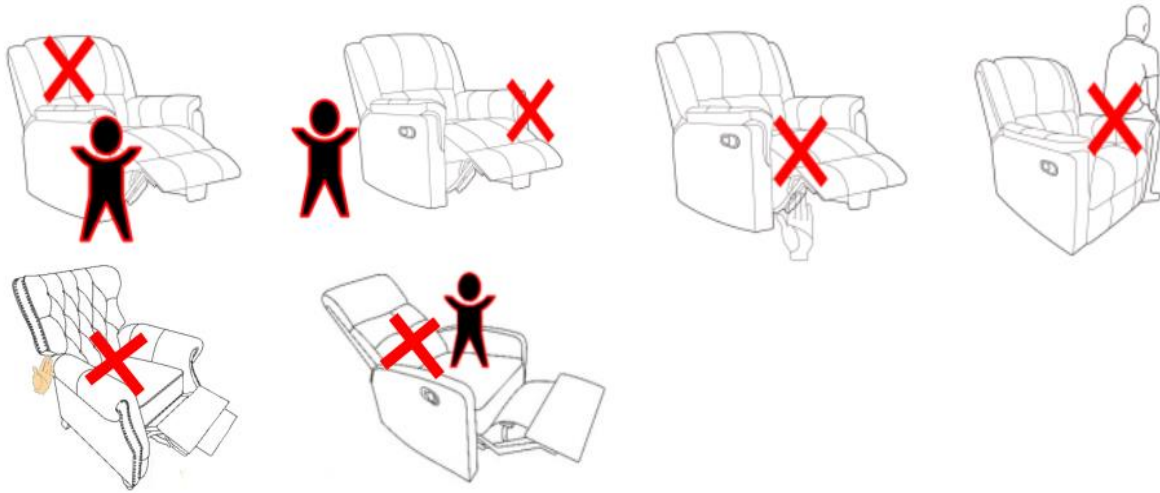

Keep hands and feet clear of the footrest mechanism and any gaps.  
Do not allow children to play on the chair.  
Always leave the chair in an upright and closed position after use.  
Do not sit on the arms of the recliner.  
Do not stand upon the recliner.  
Only the occupant should operate the chair.

## User Instructions

### Recliner Chair

Please read the Instruction Manual below carefully before use.

This is a Recliner Chair. At anytime in a reclined seat position or in the upright position. You may enjoy the rocking motion by using your body weight in a back-front rocking motion.

Supervise children, when in use of this Recliner.

#### To get into the Recline position:

Sit into the seat.  
Open the trigger on the outside of right armrest.  
Use your body weight and push backwards into the seat into a fully reclined position.

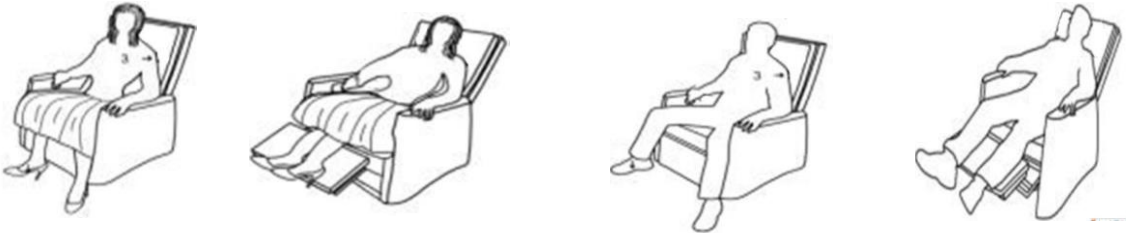

**To move the Chair back into the Upright Position:**

Tilt your body weight slightly forward and upwards.





















The seat back will come up to an upright position.

Use your feet to push the footrest back. You can stand up when the footrest and the mechanism clicked.

Where necessary, use either your arms help lift- push yourself out of the seat.



## Care & Maintenance

-   ● Do not put hot items directly on furniture surface
  -   ● Do not clean furniture with harsh cleansers or polish.
  -   ● Do not place furniture under direct sunlight.
  -   ● Do not place furniture near heating or cooling vents.
  -   ● Do not write on furniture without a padded barrier to protect the surface.
  -   ● Do not place furniture outside . For indoor use only .
  -   ● Not for commercial use. For residential use only .
  -   ● Stains may be removed with mild soap solution and damp cloth.
  -   ● Children should not climb or jump on the furniture.
- 
-   ● Dust and pick-up spills using a clean, non-colored, lint-free cloth .

### Questions & Answers about Proposition 65

#### • What is Proposition 65?

Proposition 65 requires businesses to provide warnings to Californians about significant exposures to chemicals that cause cancer, birth defects or other reproductive harm. These chemicals can be in the products that Californians purchase, in their homes or workplaces, or that are released into the environment. By requiring that this information be provided, Proposition 65 enables Californians to make informed decisions about their exposures to these chemicals.

Proposition 65 also prohibits California businesses from knowingly discharging significant amounts of listed chemicals into sources of drinking water.

Proposition 65 requires California to publish a list of chemicals known to cause cancer, birth defects or other reproductive harm. This list, which must be updated at least once a year, has grown to include approximately 900 chemicals since it was first published in 1987.

#### • What types of chemicals are on the Proposition 65 list?

The list contains a wide range of naturally occurring and synthetic chemicals that include additives or ingredients in pesticides, common household products, food, drugs, dyes, or solvents. Listed chemicals may also be used in manufacturing and construction, or they may be byproducts of chemical processes, such as motor vehicle

#### • What does a warning mean?

If a warning is placed on a product label or posted or distributed at a workplace, a business, or in rental housing, the business issuing the warning is aware or believes that it is exposing individuals to one or more listed chemicals.

By law, a warning must be given for listed chemicals unless the exposure is low enough to pose no significant risk of cancer or is significantly below levels observed to cause birth defects or other reproductive harm.

#### • Where can I get more information on Proposition 65?

If you have specific questions on the administration or implementation of Proposition 65, you can contact OEHHA's Proposition 65 program at [P65.Questions@oehha.ca.gov](mailto:P65.Questions@oehha.ca.gov), or by phone at (916) 445-6900.