

# ASSEMBLY INSTRUCTION

SKU CODE:(N750P244866/N750P244869)

TWIN SIZE LOFT BED WITH DESK,  
SHELVES AND BACKBOARD

# INSTRUCTIONS DE MONTAGE

SKU NUMBER: (N750P244866/N750P244869)

LIT DOUBLE MEZZANINE AVEC BUREAU,  
ÉTAGÈRES ET PANNEAU ARRIÈRE



## **SAFETY WARNINGS AND GENERAL NOTES:**

1. Follow the information on the warnings appearing on the upper bunk bed end structure and on the carton. Do not remove the warning label from the bed.
2. Always use the recommended size mattress or mattress support, or both, to help prevent the likelihood of entrapment or falls.
3. Do not allow children under 6 years of age to use the upper bunk.
4. Periodically check and ensure the guardrail, ladder and other components are in their proper position, free from damage, and all connectors are tight.
5. Do not allow horseplay on or under beds.
6. Always prohibit jumping on the bed.
7. Prohibit more than one person on upper bunk.
8. Always use the ladder for entering and leaving the upper bunk.
9. Do not use substitute parts. Contact the manufacturer or dealer for replacement parts.
10. Use of a night light may provide added safety precaution for a child using the upper bunk.
11. Always use guardrails on both long sides of the upper bunk.
12. If the bunk bed will be placed next to a wall, the guardrail that runs the full length of the bed should be placed against the wall to prevent entrapment between the bed and the wall. The use of water or sleep flotation mattresses is prohibited.
13. **STRANGULATION HAZARD**-Never attach or hang items to any part of the bunk bed that are not designed for use with the bed. for example, but not limited to, hooks, belts and jump ropes.
14. Keep these instructions for future reference.
15. We recommend assembling your bunk bed on the shipping carton to protect your floor or carpet.
16. Be certain all staples are out of the box before beginning assembly on the shipping carton.
17. **USE ONLY MATTRESSES WHICH ARE AS THE TABLE BELOW ON UPPER BUNKS.**

Upper bed (bunk bed and tribed included)

Bed type	Length	Width	Thickness
Twin Standard	74" - 75"	38 1/2"	6" max

18. **SURFACE OF MATTRESS MUST BE AT LEAST 5" (127MM) BELOW THE UPPER EDGE OF GUARDRAILS.**

19. **Replacement Parts:**

Replacement Parts, including additional guardrails, may be obtained from any of our (GIGACLOUD TECHNOLOGY (USA) INC. ) dealers.

## **AVERTISSEMENTS DE SÉCURITÉ ET REMARQUES GÉNÉRALES :**

1. Suivez les informations figurant sur les avertissements figurant sur la structure d'extrémité du lit superposé supérieur et sur le carton. Ne retirez pas l'étiquette d'avertissement du lit.
2. Utilisez toujours le matelas ou le support de matelas de taille recommandée, ou les deux, pour éviter tout risque de coincement ou de chute.
3. Ne laissez pas les enfants de moins de 6 ans utiliser le lit supérieur.
4. Vérifiez périodiquement et assurez-vous que le garde-corps, l'échelle et les autres composants sont dans leur bonne position, exempts de dommages et que tous les connecteurs sont bien serrés.
5. Ne laissez pas les chahuts sur ou sous les lits.
6. Interdisez toujours de sauter sur le lit.
7. Interdire plus d'une personne sur la couchette supérieure.
8. Utilisez toujours l'échelle pour entrer et sortir du lit supérieur.
9. N'utilisez pas de pièces de rechange. Contactez le fabricant ou le revendeur pour obtenir des pièces de rechange.
10. L'utilisation d'une veilleuse peut fournir une mesure de sécurité supplémentaire pour un enfant utilisant le lit supérieur.
11. Utilisez toujours des garde-corps sur les deux côtés longs du lit supérieur.
12. Si le lit superposé doit être placé à côté d'un mur, le garde-corps qui s'étend sur toute la longueur du lit doit être placé contre le mur pour éviter tout coincement entre le lit et le mur. L'utilisation de matelas flottants à eau ou de sommeil est interdite.
13. **RISQUE D'ÉTRANGULATION** - N'attachez ou ne suspendez jamais d'objets à une partie du lit superposé qui ne sont pas conçu pour être utilisé avec le lit, par exemple, mais sans s'y limiter, des crochets, des ceintures et des cordes à sauter.
14. Conservez ces instructions pour référence future.
15. Nous vous recommandons d'assembler votre lit superposé sur le carton d'expédition pour protéger votre sol ou votre tapis.
16. Assurez-vous que toutes les agrafes sont sorties de la boîte avant de commencer l'assemblage sur le carton d'expédition.
17. **UTILISER UNIQUEMENT DES MATELAS QUI SONT COMME DANS LE TABLEAU CI-DESSOUS SUR LES SUPERPOSÉS.**

Lit supérieur (lits superposés et triblés inclus)

Type de lit	Longueur	Largeur	Épaisseur
Double Standard	74" - 75"	38 1/2"	6" max







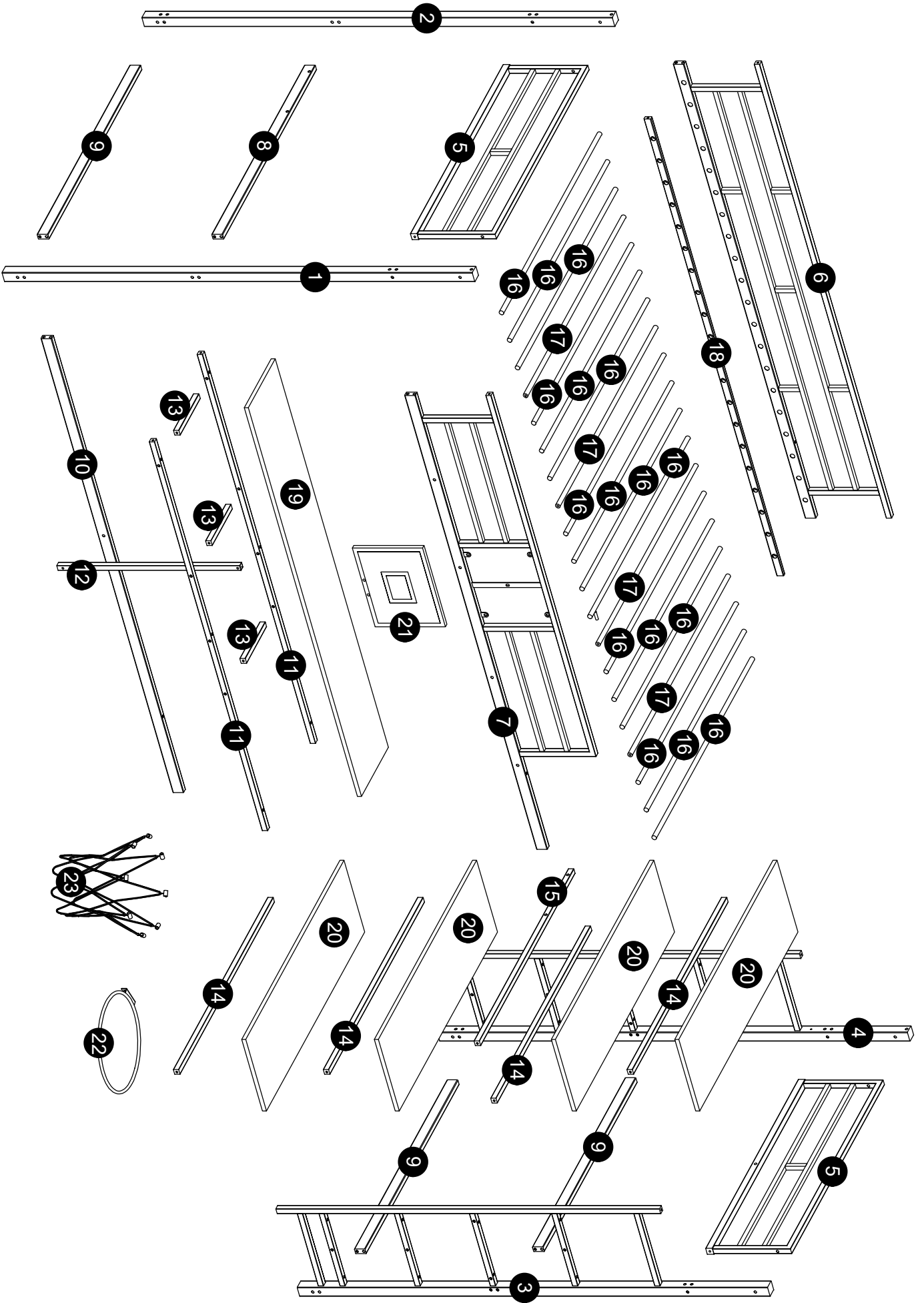

18. **LA SURFACE DU MATELAS DOIT ÊTRE AU MOINS 5" (127 MM) EN DESSOUS DU BORD SUPÉRIEUR DES GARDE-CORPS.**

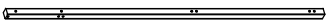
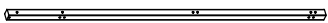
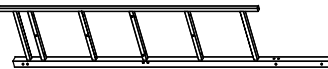
19. Pièces de rechange :

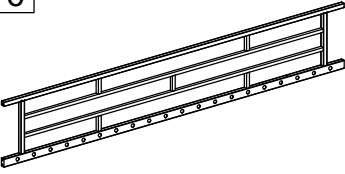
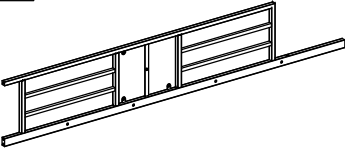

Les pièces de rechange, y compris les garde-corps supplémentaires, peuvent être obtenues auprès de l'un de nos revendeurs (GIGACLOUD TECHNOLOGY (USA) INC. )

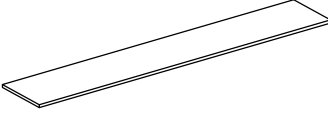
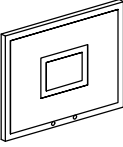

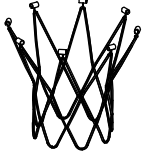



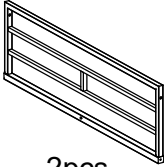
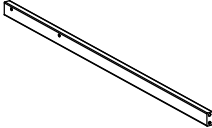
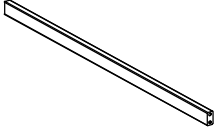
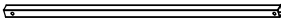

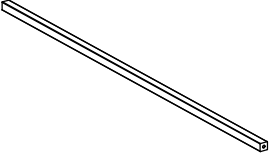
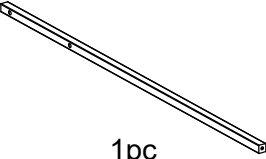
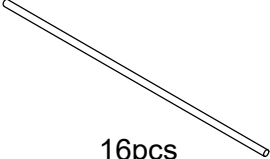
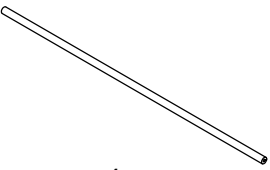
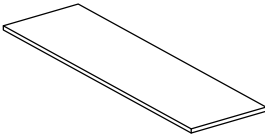

# Parts List /Liste des pièces N750P244866

<p>1</p>  <p>1pc</p>	<p>2</p>  <p>1pc</p>	<p>3</p>  <p>1pc</p>	<p>4</p>  <p>1pc</p>
<p>6</p>  <p>1pc</p>	<p>7</p>  <p>1pc</p>	<p>10</p>  <p>1pc</p>	<p>11</p>  <p>2pcs</p>
<p>18</p>  <p>1pc</p>	<p>19</p>  <p>1pc</p>	<p>21</p>  <p>1pc</p>	<p>22</p>  <p>1pc</p>
<p>23</p>  <p>1pc</p>			

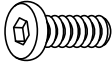
# Parts List /Liste des pièces N750P244869

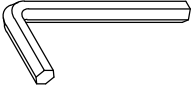
<p>5</p>  <p>2pcs</p>	<p>8</p>  <p>1pc</p>	<p>9</p>  <p>3pcs</p>	<p>12</p>  <p>1pc</p>
<p>13</p>  <p>3pcs</p>	<p>14</p>  <p>4pcs</p>	<p>15</p>  <p>1pc</p>	<p>16</p>  <p>16pcs</p>
<p>17</p>  <p>4pcs</p>	<p>20</p>  <p>4pcs</p>		

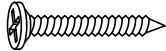

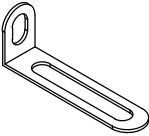
# Hardware List / Liste du matériel N750P244866

<p><b>A</b></p>  <p>M6*60mm 38pcs</p>	<p><b>B</b></p>  <p>M6*45mm 26pcs</p>	<p><b>C</b></p>  <p>M6*30mm 24pcs</p>
<p><b>D</b></p>  <p>M6*16mm 8pcs</p>	<p><b>E</b></p>  <p>M6*12mm 7pcs</p>	<p><b>F</b></p>  <p>M6 8pcs</p>
<p><b>G</b></p>  <p>2pcs</p>	<p><b>H</b></p>  <p>2pcs</p>	<p><b>I</b></p>  <p>2pcs</p>
<p><b>J</b></p>  <p>Ø4*14mm 2pcs</p>	<p><b>K</b></p>  <p>2pcs</p>	

# STEP 1:

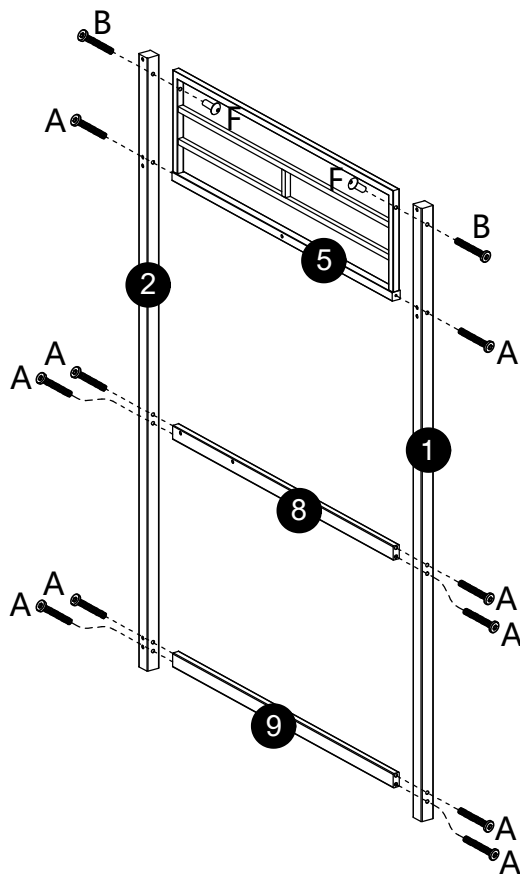
## Étape 1:





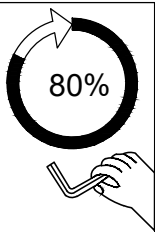

<b>A</b>
 M6*60mm 10PCS
<b>B</b>
 M6*45mm 2PCS
<b>F</b>
 M6 2PCS

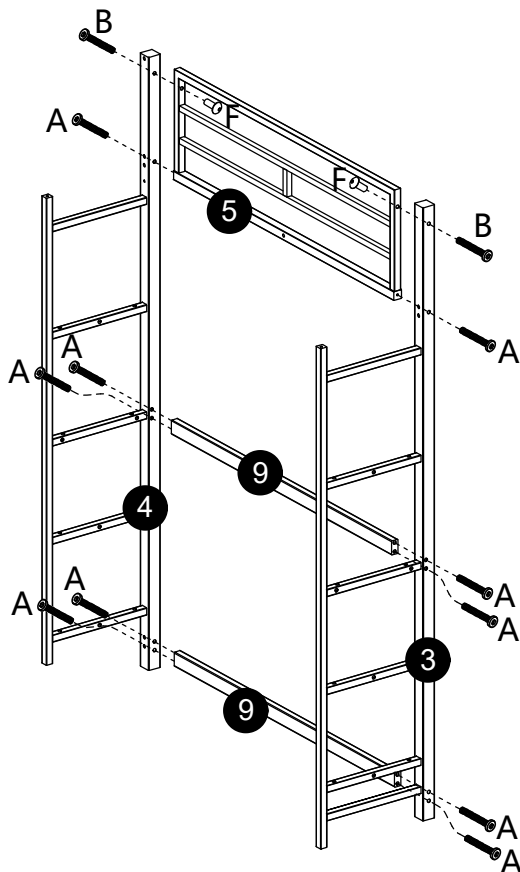

# STEP 2:

## Étape 2:



<b>A</b>
 M6*60mm 10PCS
<b>B</b>
 M6*45mm 2PCS
<b>F</b>
 M6 2PCS

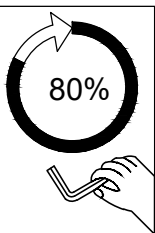

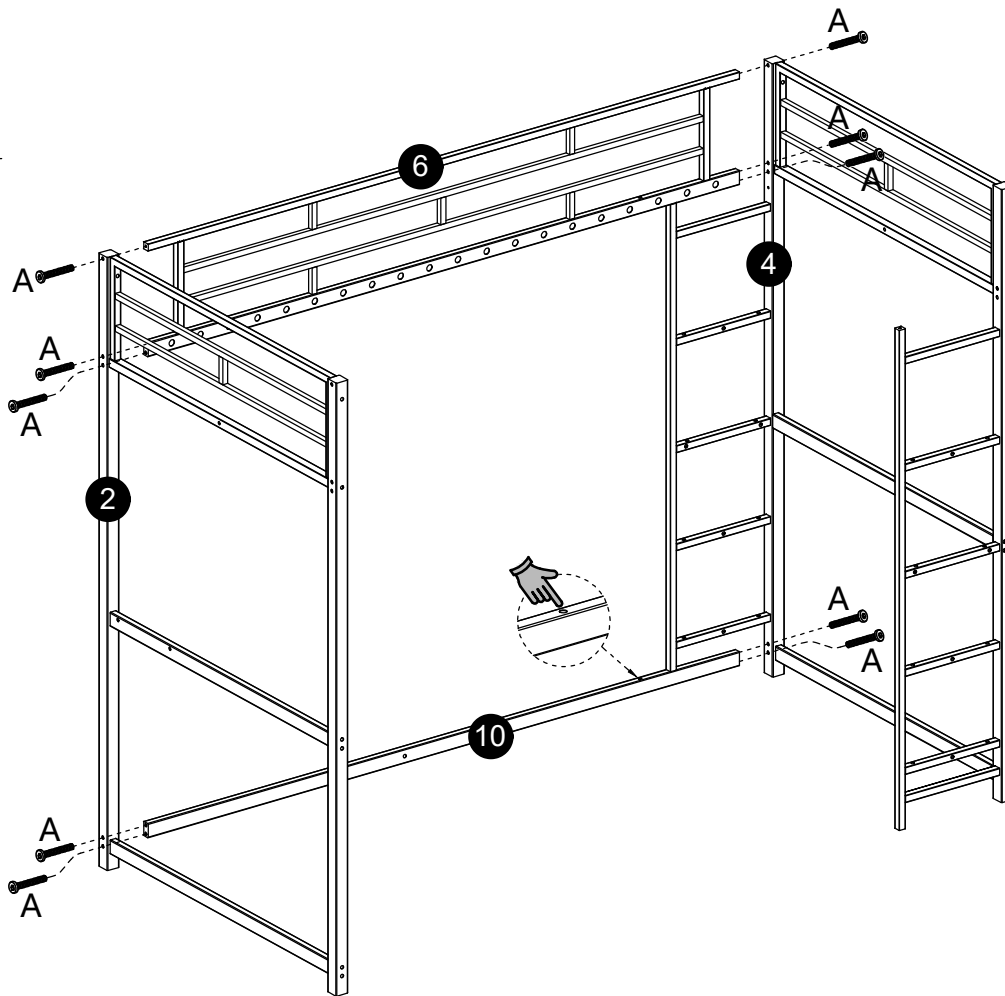

**STEP 3:**  
**Étape 2:**

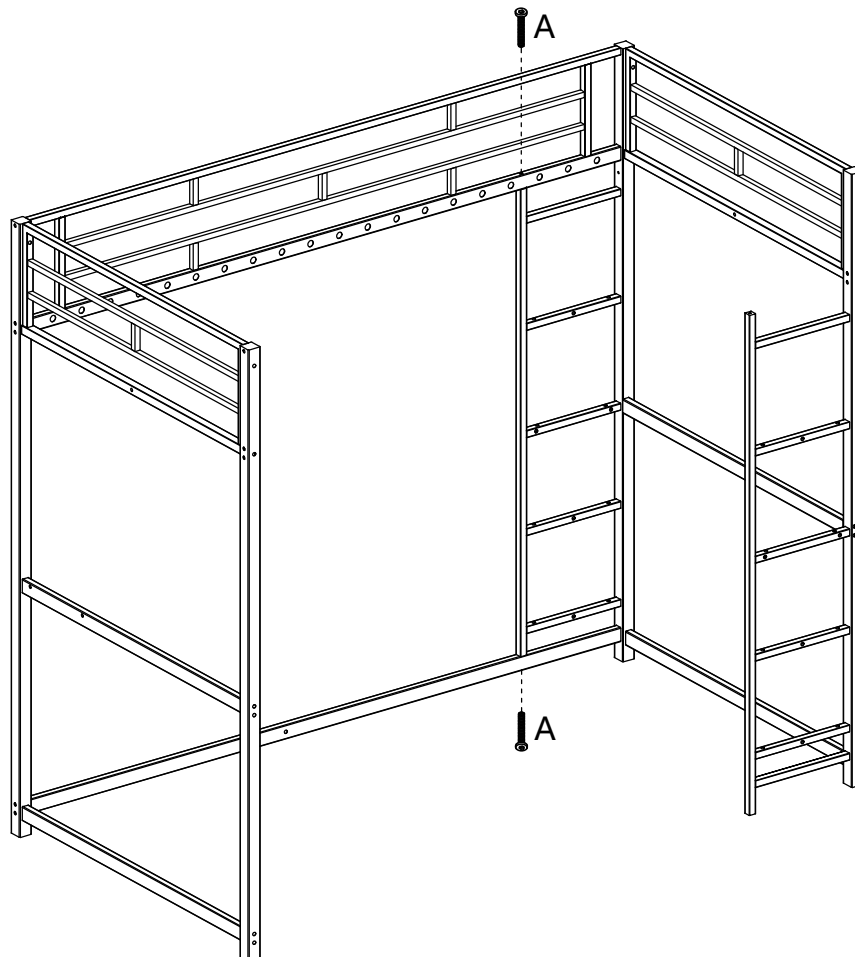

A

M6*60mm
10PCS

**STEP 4:**  
**Étape 4:**



A

M6*60mm
2PCS

**STEP 5:**  
**Étape 5:**

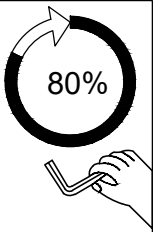
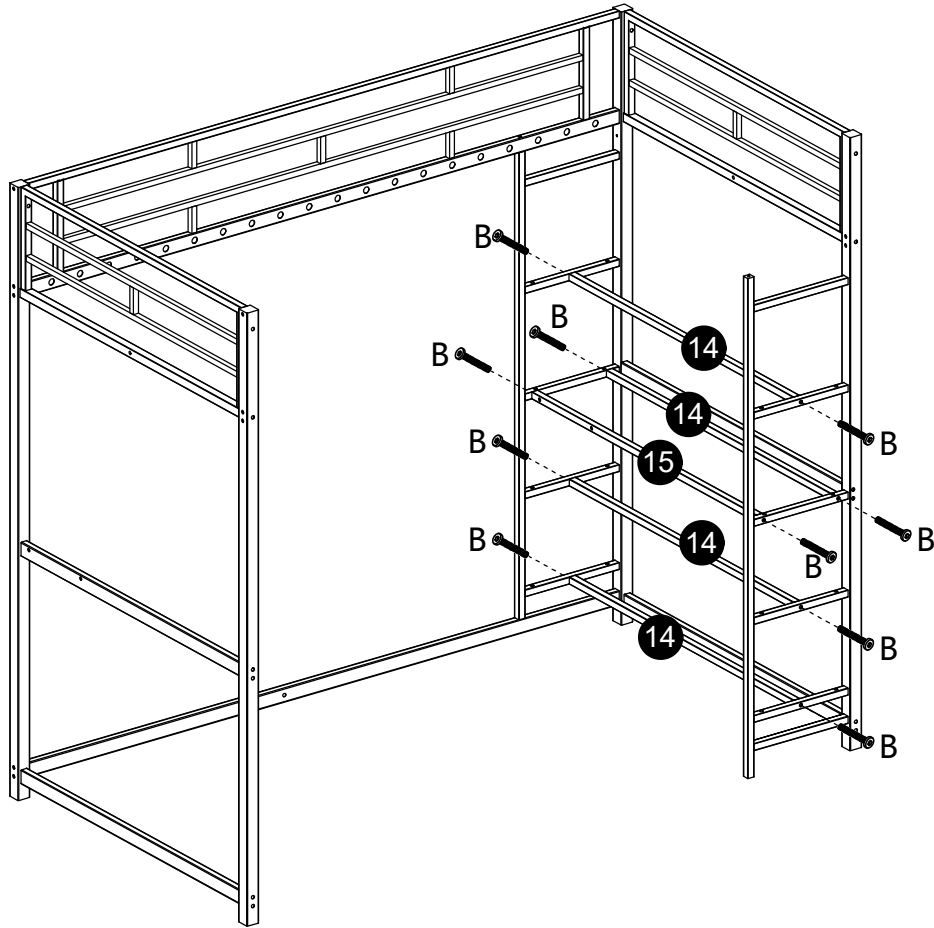
<b>B</b>

M6*45mm
10PCS



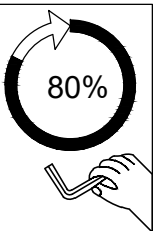
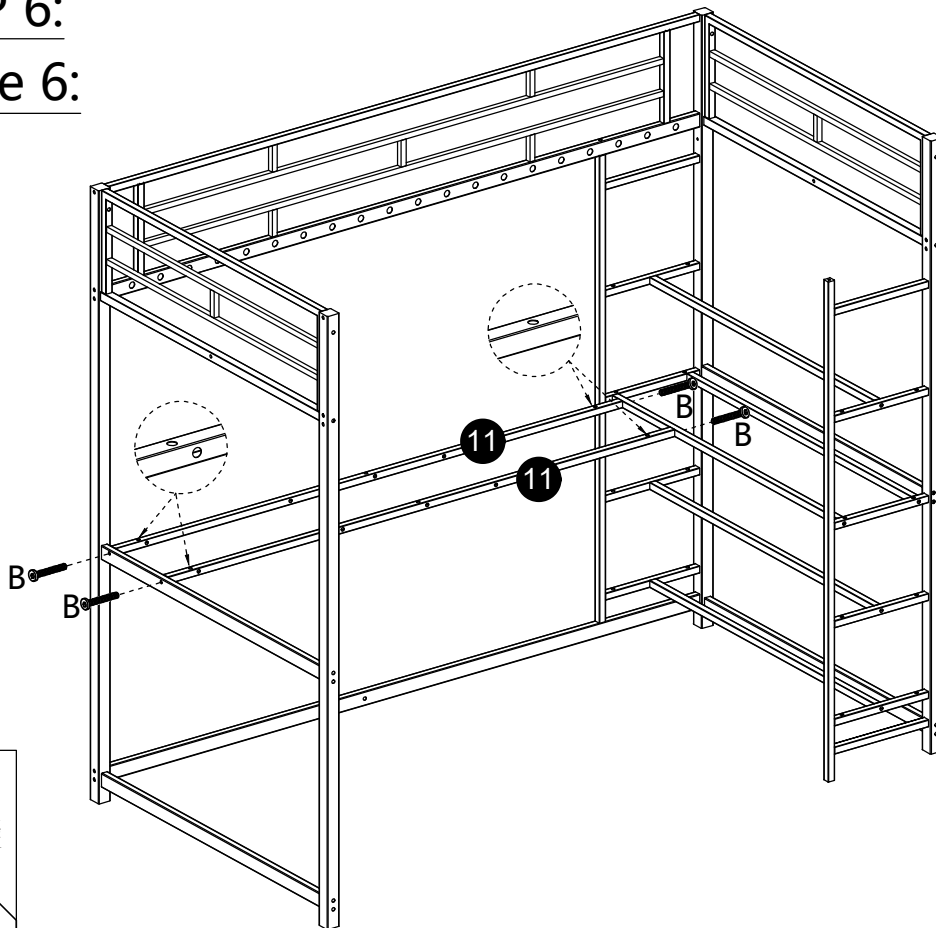

**STEP 6:**  
**Étape 6:**

<b>B</b>

M6*45mm
4PCS

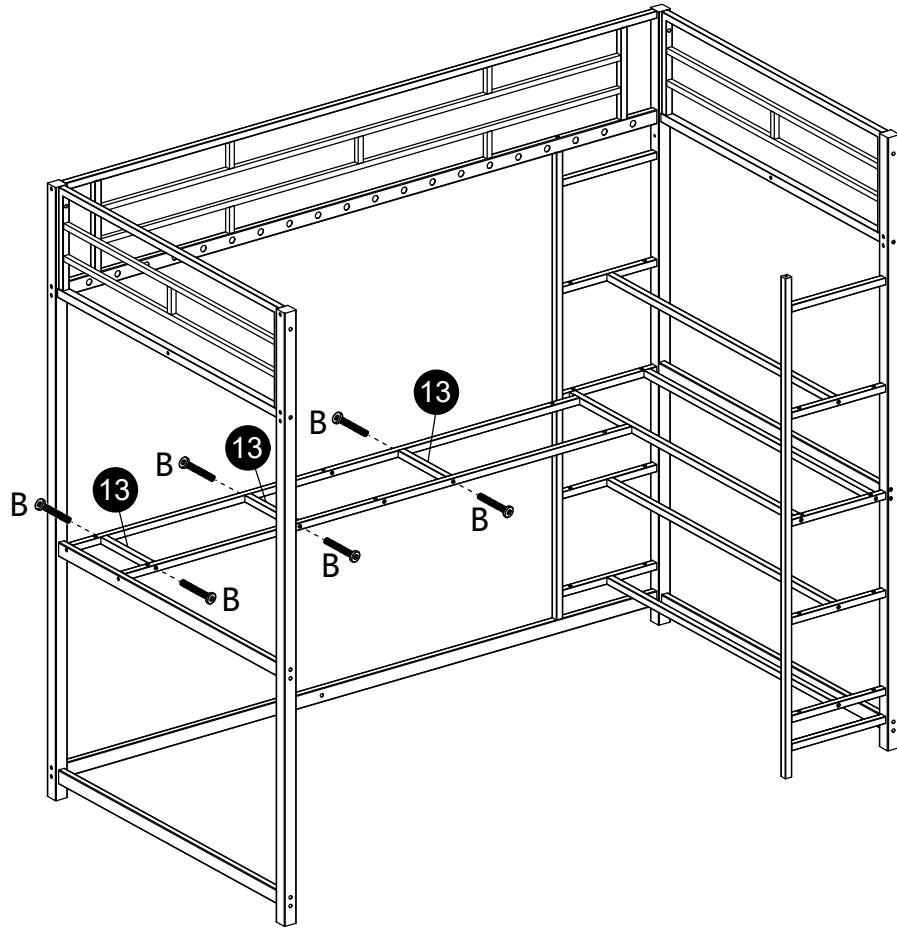

**STEP 7:**  
**Étape 7:**



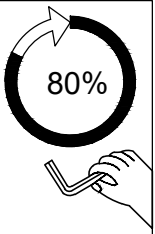

<b>B</b>

M6*45mm
6PCS

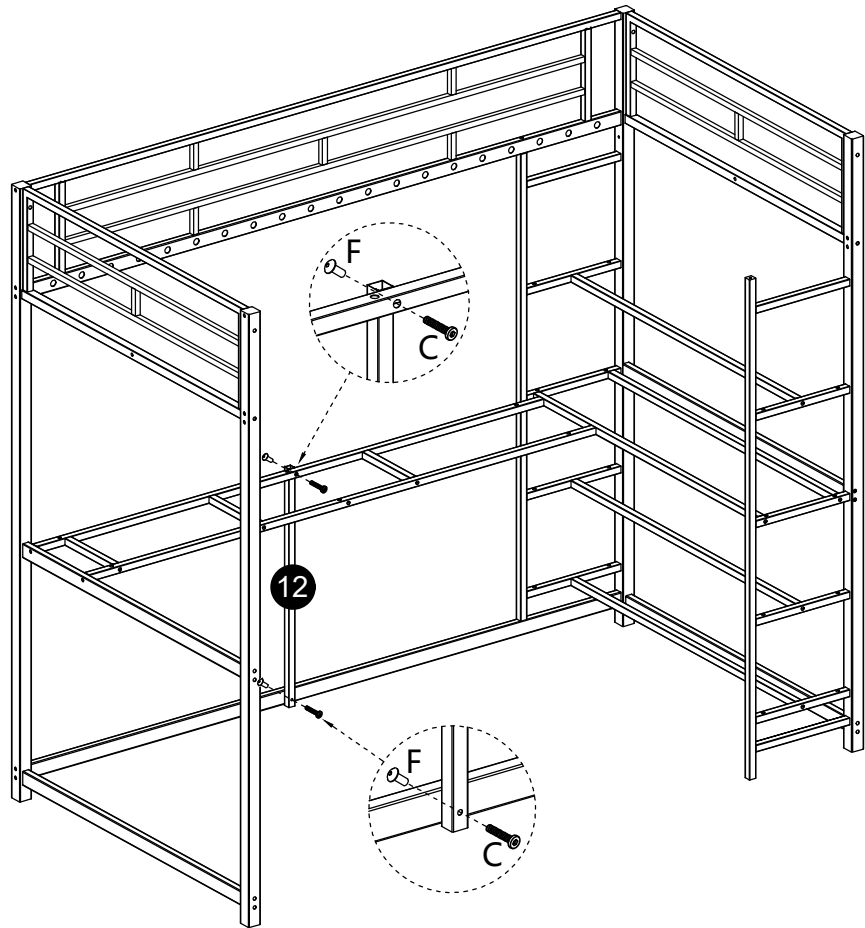

**STEP 8:**  
**Étape 8:**

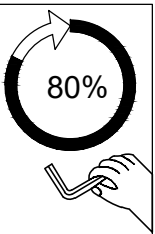

<b>C</b>

M6*30mm
2PCS
<b>F</b>

M6
2PCS

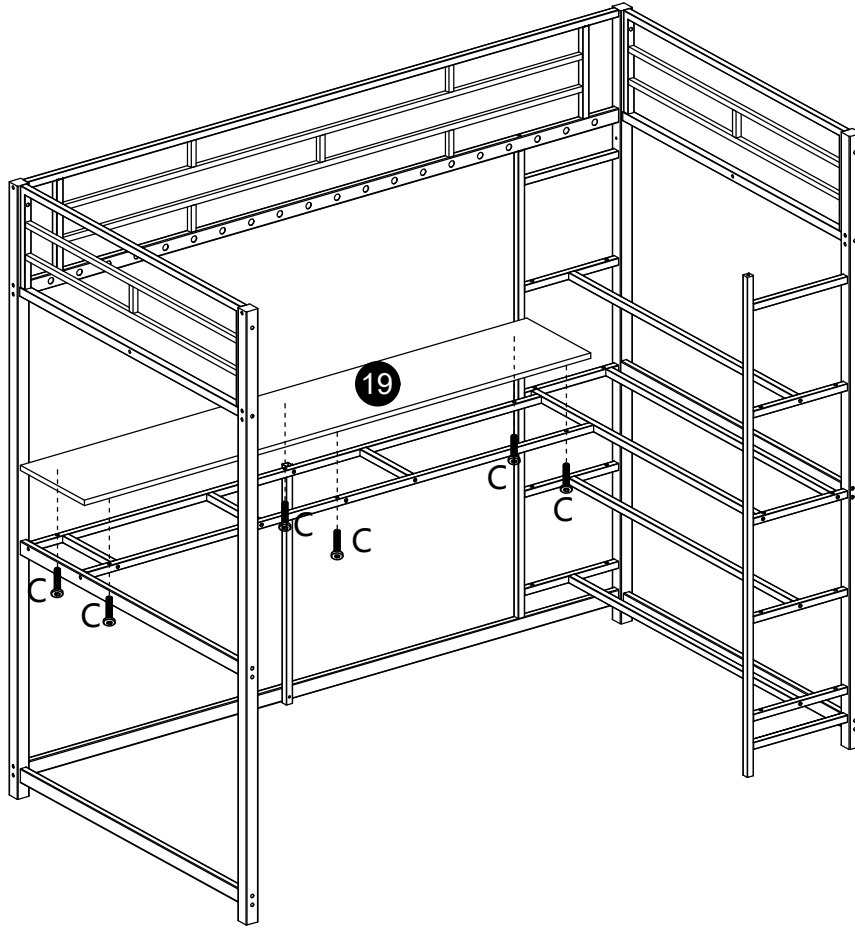

**STEP 9:**  
**Étape 9:**

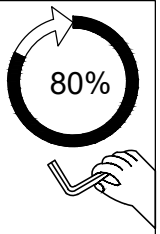

C
 M6*30mm
6PCS



**STEP 10:**  
**Étape 10:**

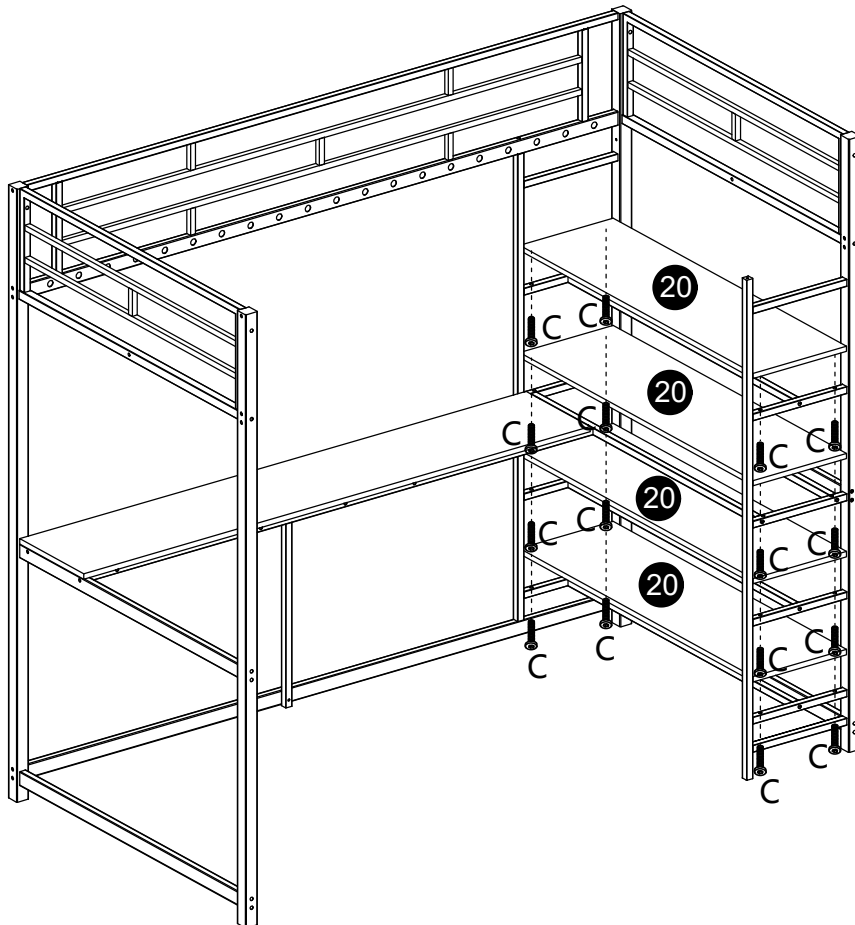

C
 M6*30mm
16PCS

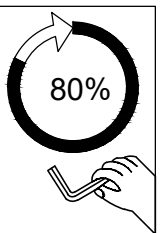

**STEP 11:**  
**Étape 11:**

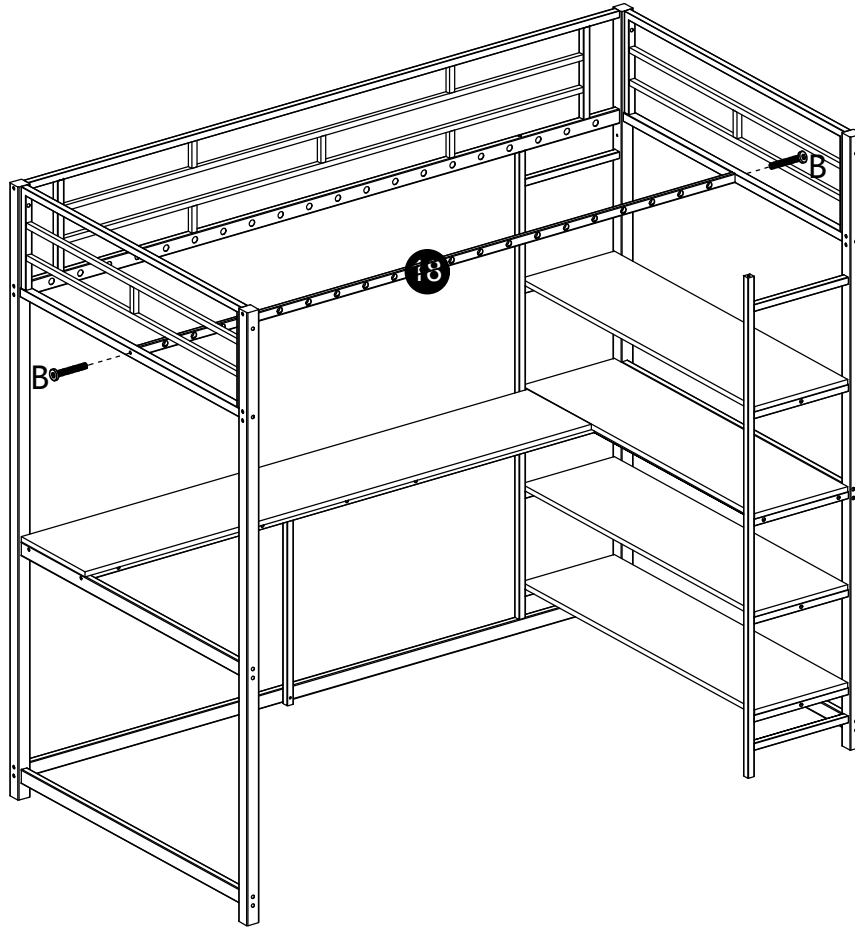

<b>B</b>

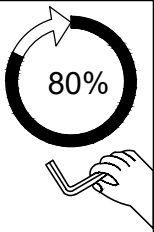
M6*45mm
2PCS

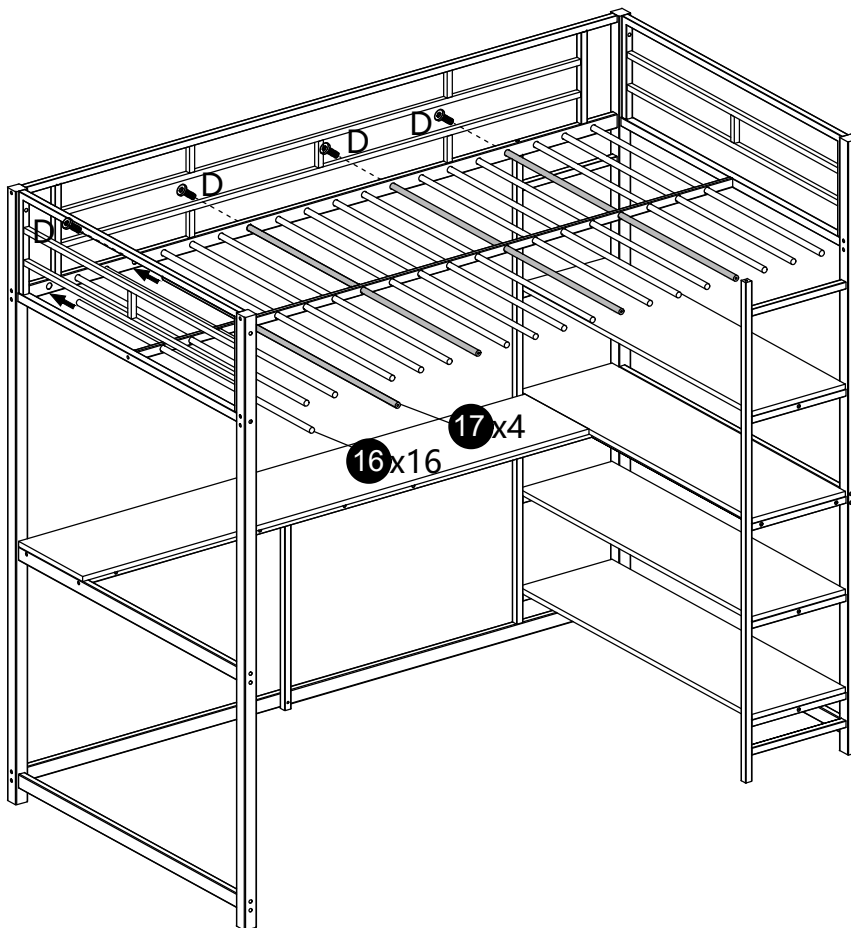

**STEP 12:**  
**Étape 12:**



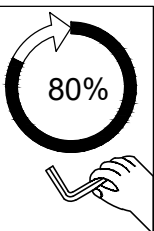

<b>D</b>

M6*16mm
4PCS

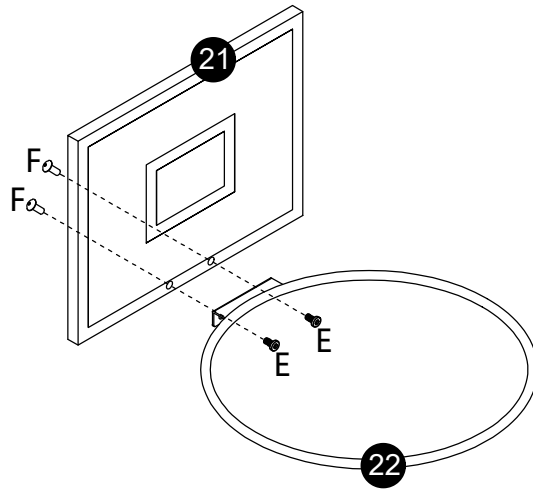

# STEP 13:

## Étape 13:



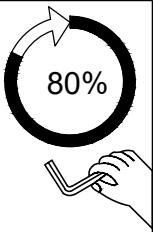

<b>E</b>
 M6*12mm
2PCS
<b>F</b>
 M6
2PCS

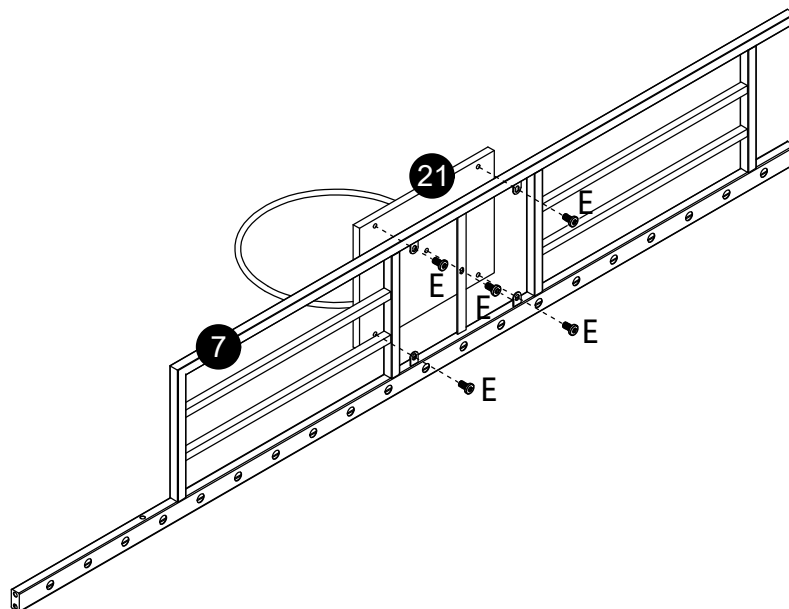

# STEP 14:

## Étape 14:



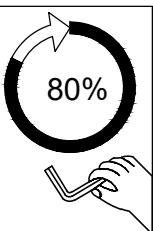

<b>E</b>
 M6*12mm
5PCS

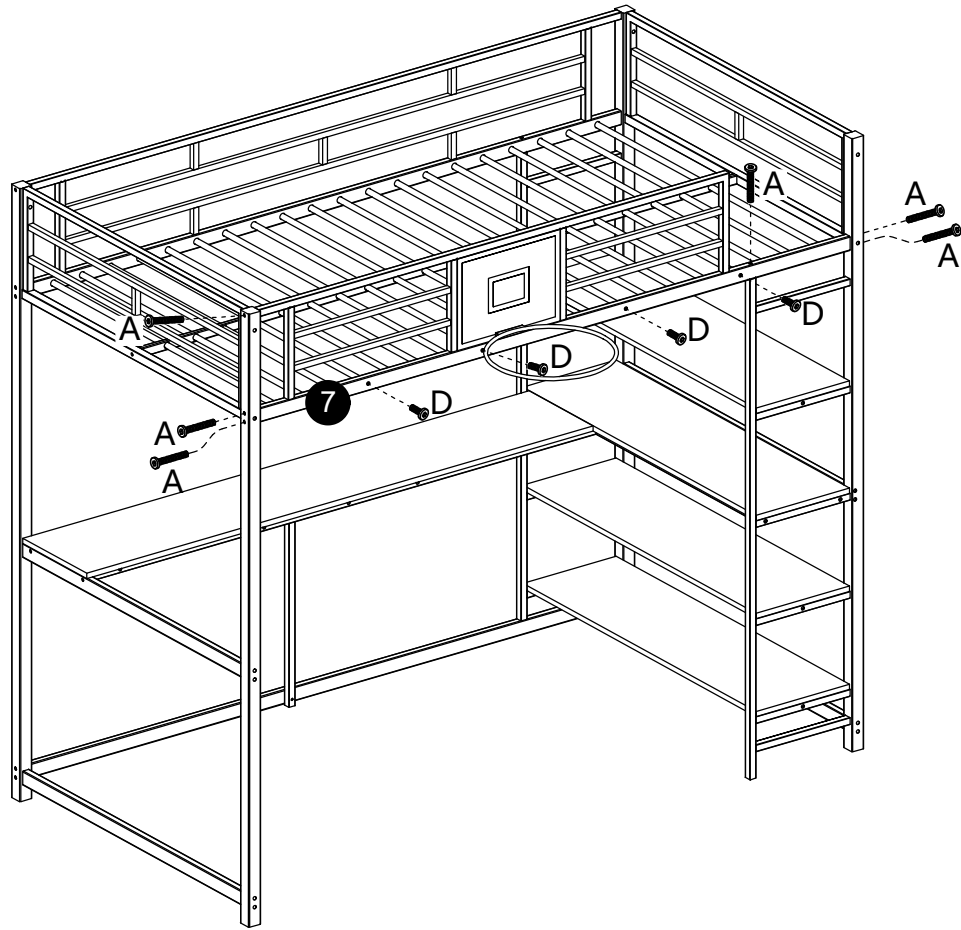

**STEP 15:**  
**Étape 15:**



<b>A</b>
 M6*60mm 6PCS
<b>D</b>
 M6*16mm 4PCS

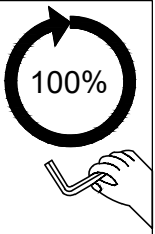

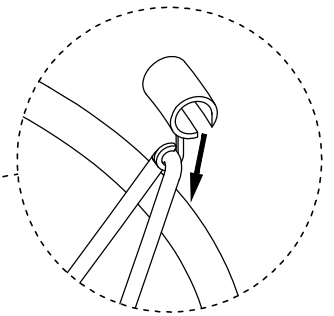
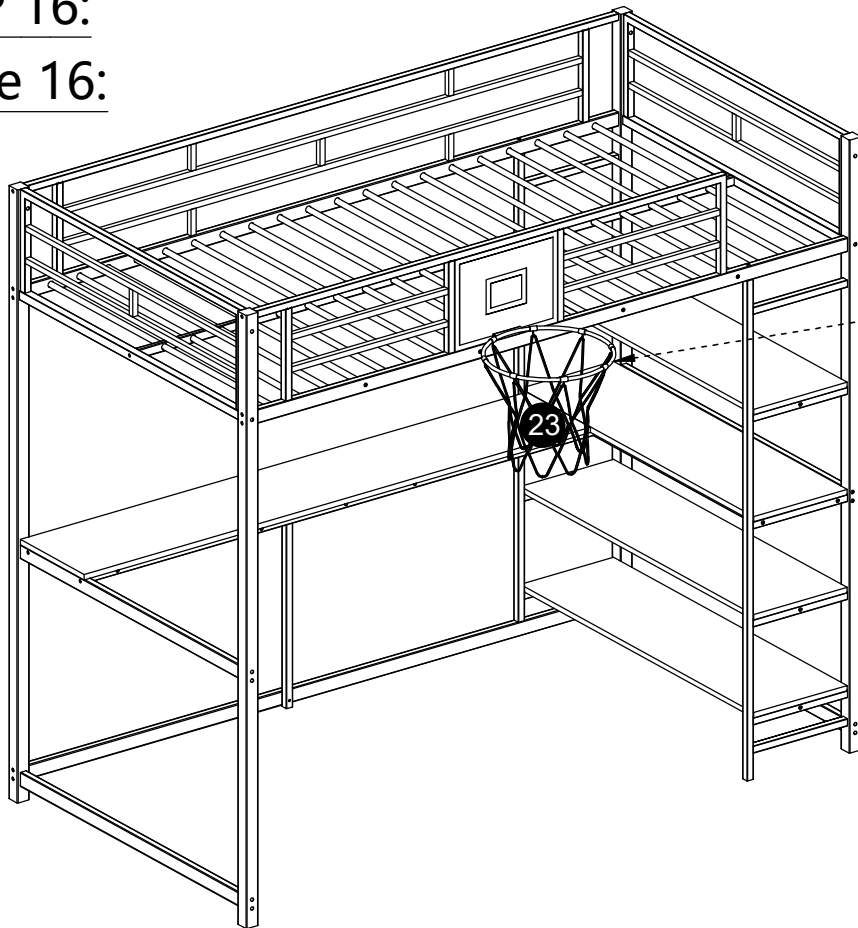

**STEP 16:**  
**Étape 16:**

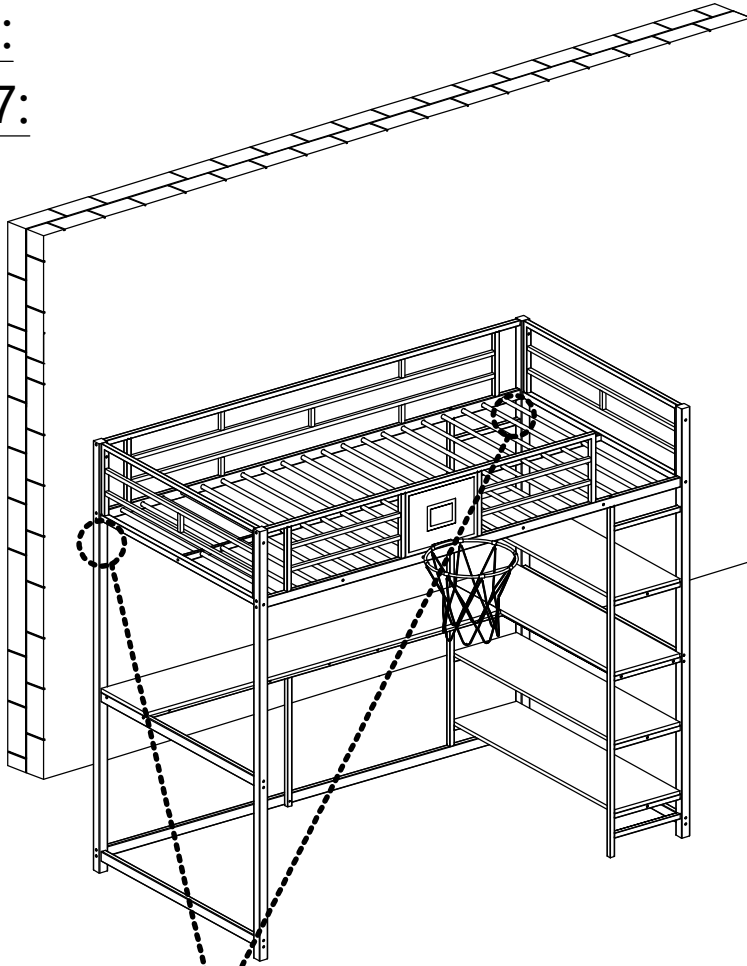

**STEP 17:**  
**Étape 17:**

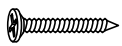

H	I
	
2PCS	2PCS
K	J
	
2PCS	2PCS

