







MASSAGE SOFA

A 	B 	C 	D 	E 	F 	
Chair base	Backrest	Left and right amrest	Power cord	Power Sourcr	Remote control	Lift control

You will receive totally 2 boxes, please make sure you get 1x(A) box and 1x(B) box before assembly.
Just feel free to chat us if you have any problem, we will try our best to help you solve the issue

STEP1

Take out the chair base from the box.

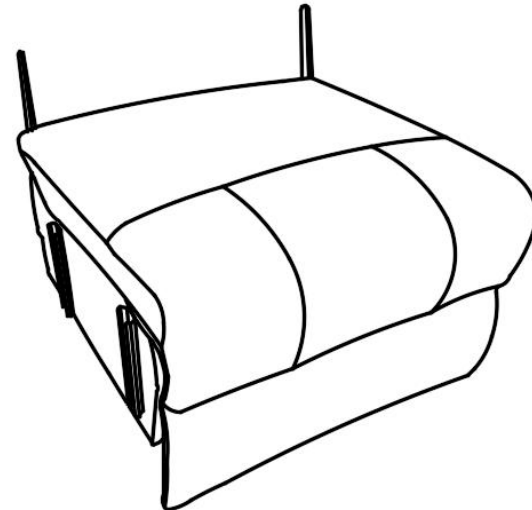

MASSAGE SOFA

STEP2

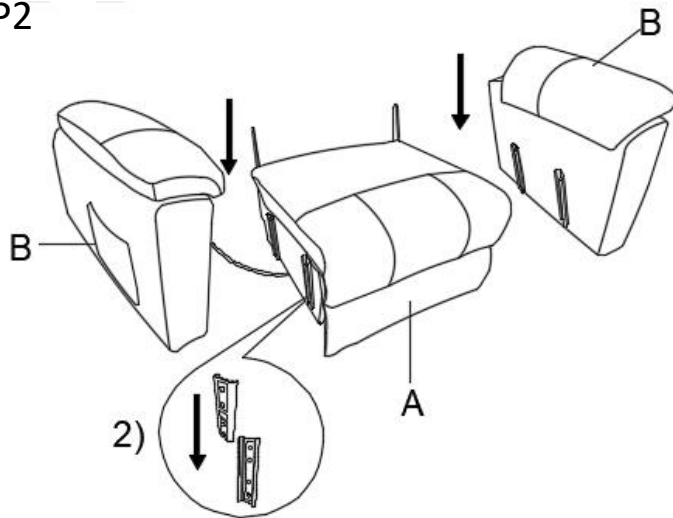

Assemble left and right armrests into the slote on the chair base.

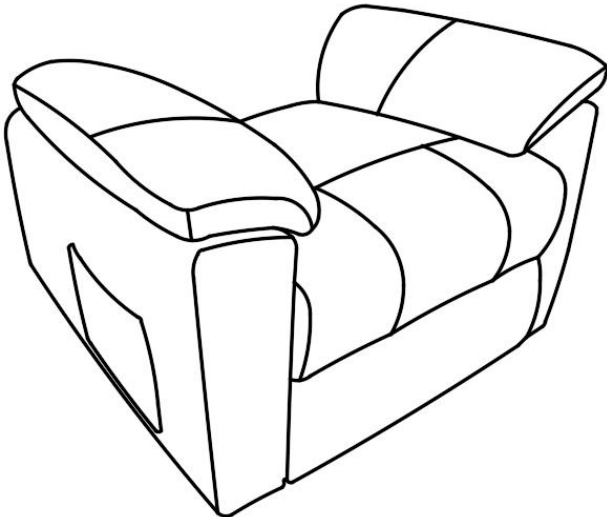

STEP3

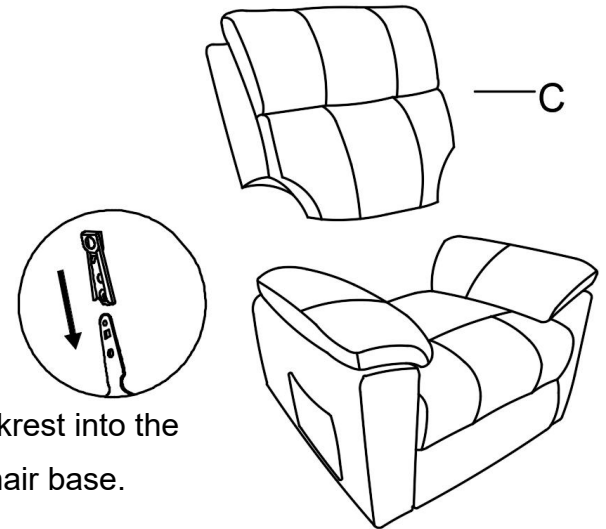

Assemble backrest into the slote on the chair base.

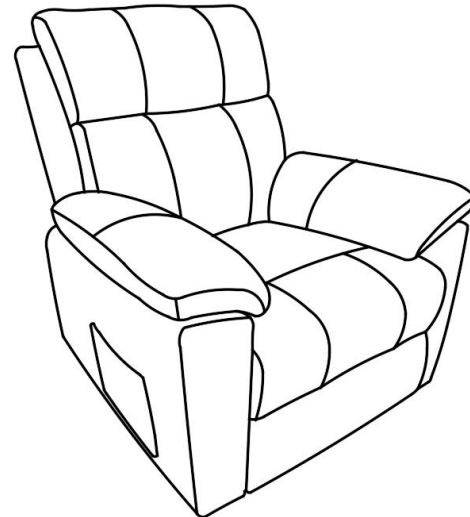

MASSAGE SOFA

STEP4

No.1 and No.2 wire connect with the backrest and chairbase
No.3 wire connects with backrest and power cord(D)

Note:TWO SAME COLOR WIRES CONNECT.

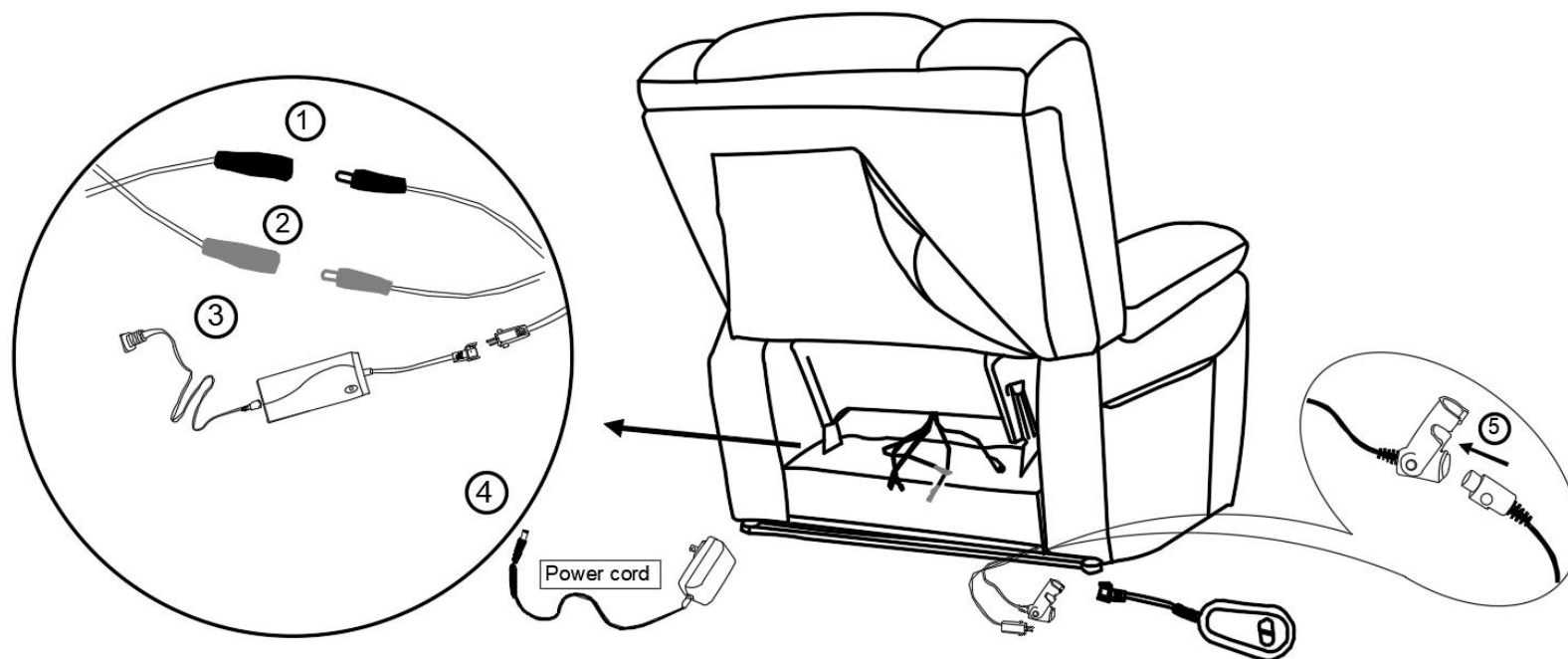

MASSAGE SOFA



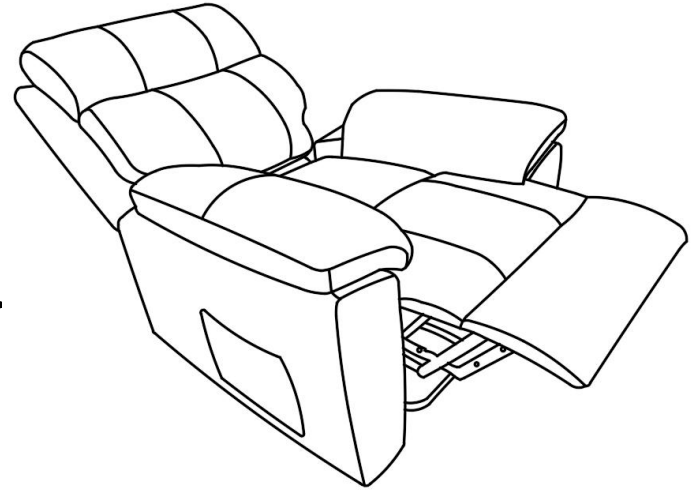
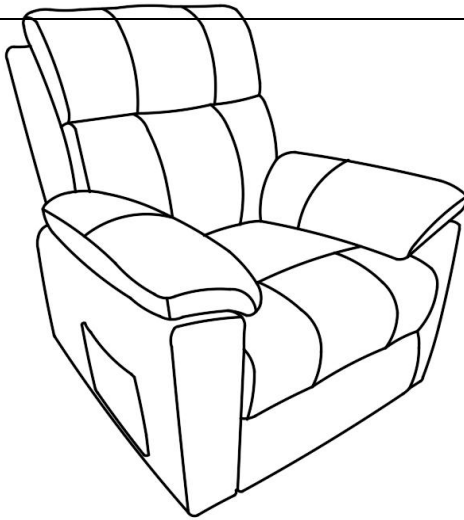
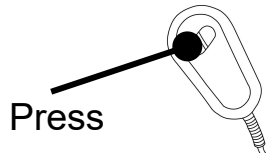

How to recline?

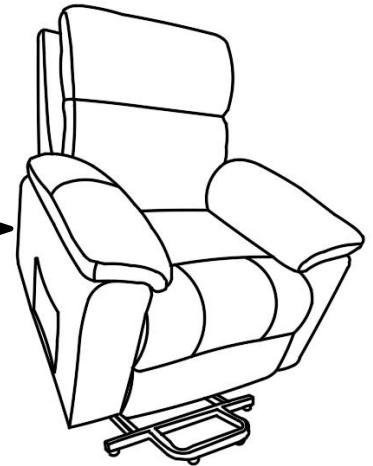
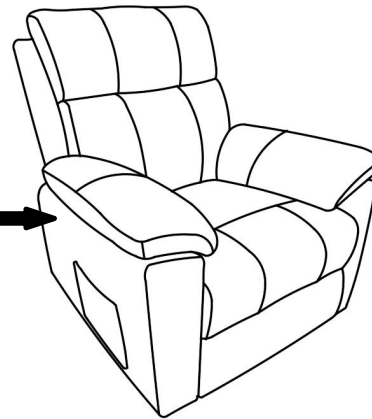
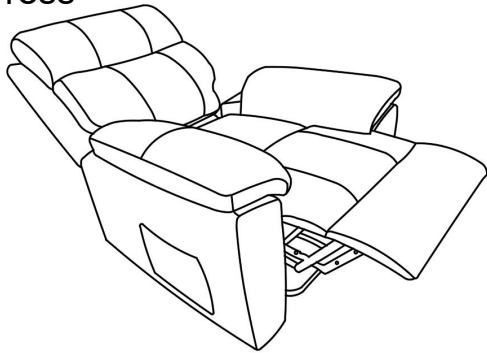
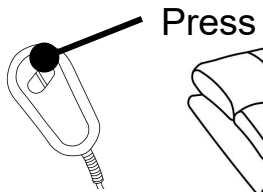

How to get footrest latch down and stand?



MASSAGE SOFA INSTRUCTION

-  POWER: Turn on/off remote control
-  HEAT: Turn on/off the heat function
-  MODE: Choose one massage mode you like
-  INT: Control the massage intensity
-  POSITION: Turn on the massage power and choose the desired position

