

**MODEL/MODELO
G77122**

Assembly Instructions

Instrucciones De Ensamblaje

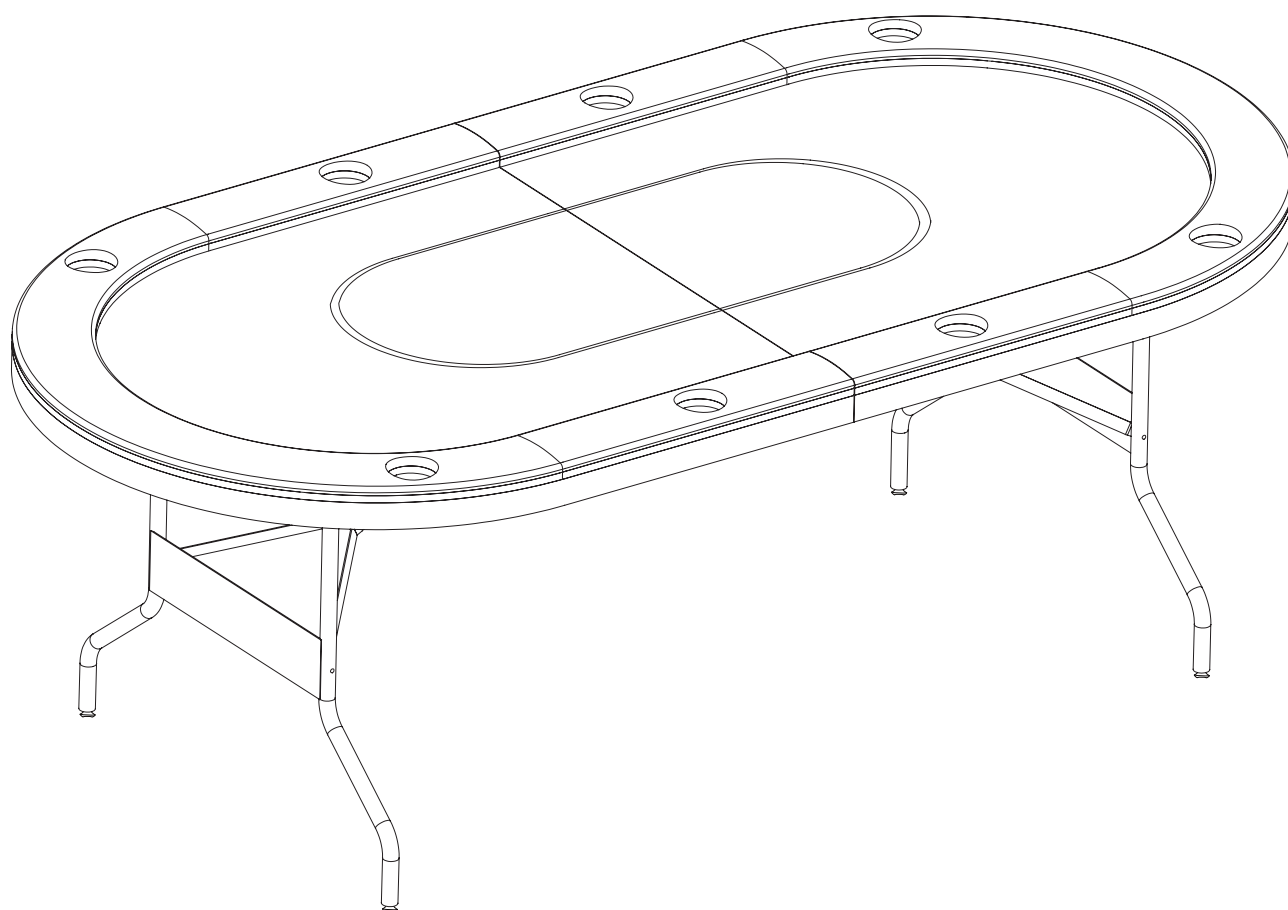

PARTS IDENTIFIER

IDENTIFICADOR DE PIEZAS

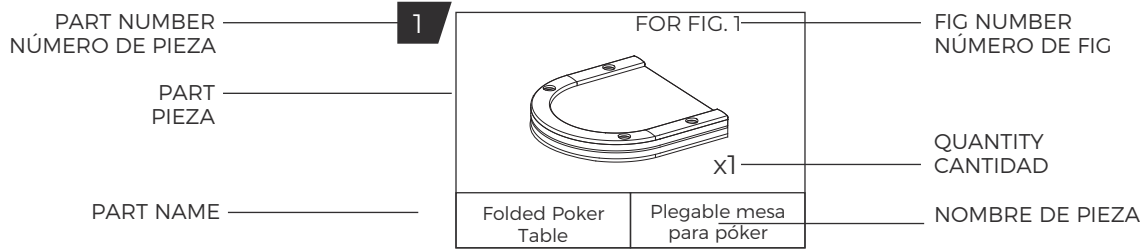





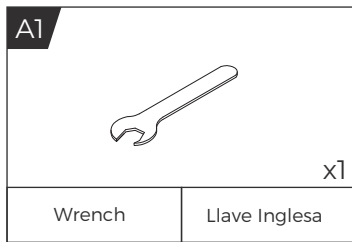



HARDWARE

HARDWARE



PRE-INSTALLED PARTS

PIEZAS PREINSTALADAS

<p>P1 FOR FIG. 2</p>  <p>x4</p> <p>"U" Bracket Corchete "U"</p>	<p>P2 FOR FIG. 2</p>  <p>x16</p> <p>4x15mm Screw Tornillo 4x15mm</p>	<p>P3 FOR FIG. 1</p>  <p>x8</p> <p>Cup Holder Portavasos</p>	<p>P4 FOR FIG. 2</p>  <p>x4</p> <p>Leg Leveler Nivelador de pata</p>
<p>P5 FOR FIG. 2</p>  <p>x1</p> <p>Steel Wire - A Cable de acero - A</p>	<p>P6 FOR FIG. 2</p>  <p>x1</p> <p>Steel Wire - B Cable de acero - B</p>	<p>P7 FOR FIG. 2</p>  <p>x1</p> <p>Butterfly Nut Tuerca de mariposa</p>	<p>P8 FOR FIG. 2</p>  <p>x1</p> <p>M5 Nut Tuerca M5</p>
<p>P9 FOR FIG. 2</p>  <p>x1</p> <p>M5 Spring Lock Washer Arandela de cerradura de resorte M5</p>			

BEFORE ASSEMBLY

ANTES DE MONTAR



1. Find a clean, level place to begin the assembly of your product.
2. Verify that you have all listed parts as shown on the part list page. If any parts are missing, call our customer service.

1. Encuentre un lugar limpio y nivelado para comenzar el ensamblaje del producto.
2. Compruebe que tenga todas las piezas que se muestran en la lista de piezas. Si falta alguna pieza, llame a nuestro servicio al cliente.

ASSEMBLY

MONTAJE





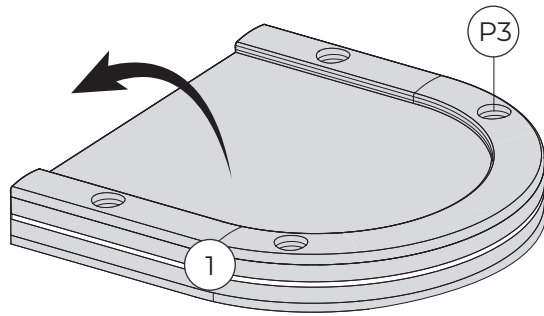



FIG. 1

- 1**  x1
- P3**  x8



Note: Unfold the Folded Poker Table (1).
 Nota: Abra la plegable mesa para póker (1).

FIG. 2

- P1**  x4
- P2**  x16
- P4**  x4
- P5**  x1
- P6**  x1
- P7**  x1
- P8**  x1
- P9**  x1

Note: To unfold the legs - Make sure that the hinges are locked in the correct position.
 Nota: Para abrir las patas - Estar seguro de tener las bisagras cerradas en la correcta posición.

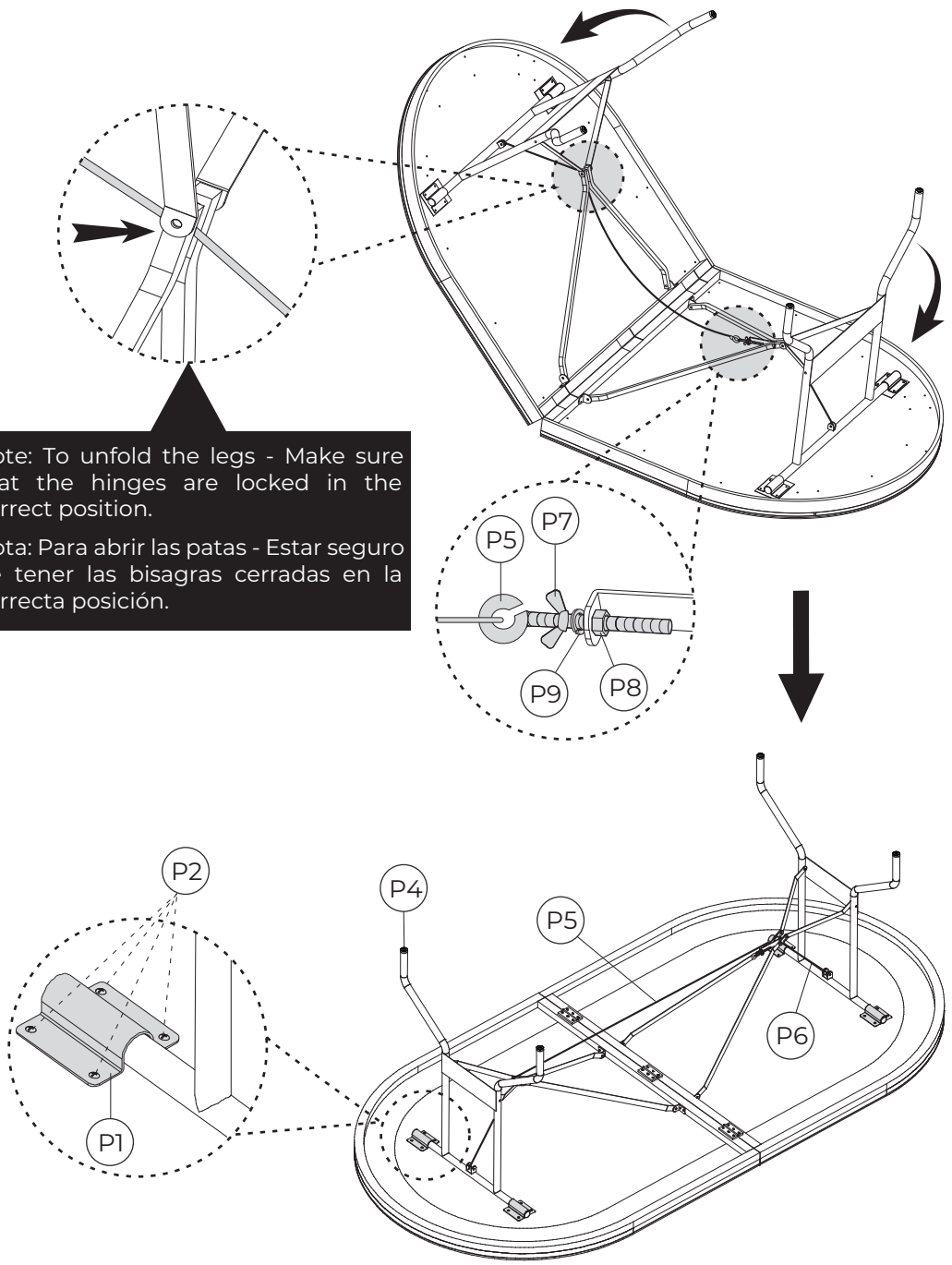

ASSEMBLY

MONTAJE

FIG. 3

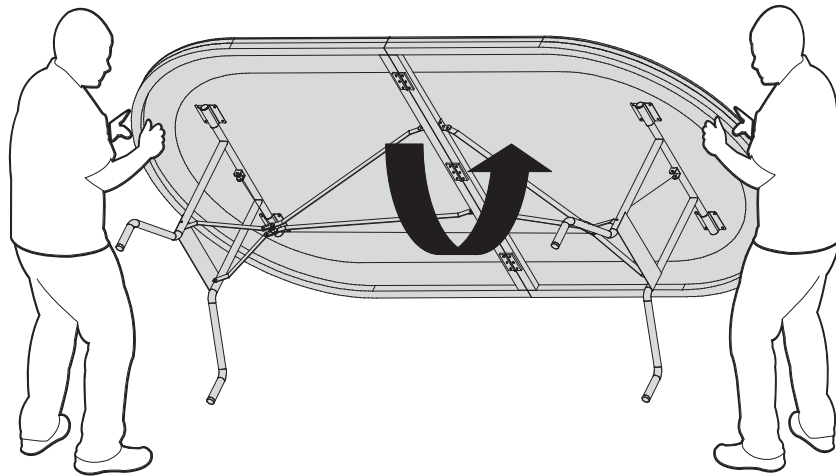

<p>HOLD BY THE TABLETOP / SOSTENER DE LA SUPERFICIE DE LA MESA</p>	<p>CABINET / GABINETE</p>	<p>DO NOT HOLD THE TABLE BY THE LEGS / NO SOSTENER LA MESA POR LAS PATAS</p>	<p>DO NOT LEAN THE TABLE ON ITS LEGS / NO INCLINAR LA MESA SOBRE LAS PATAS</p>

⚠ CAUTION

- Two strong adults are recommended to turn over the table as shown.
1. Lift the table off the ground.
 2. Turn the table over.
 3. Place it on all feet at the same time on the ground.

⚠ PRECAUCIÓN

- Se recomienda la participación de dos adultos para invertir la mesa como se muestra.
1. Levante la tabla del suelo.
 2. Voltee la mesa.
 3. Coloque las patas en el suelo al mismo tiempo.

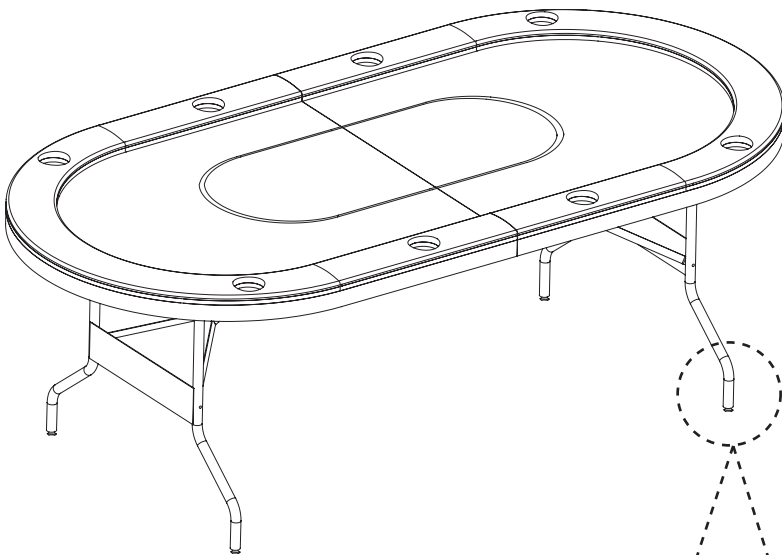

<p>ADJUST CONCAVE TABLE / AJUSTAR LA MESA CÓNCAVA</p>	<p>ADJUST CONVEX TABLE / AJUSTAR LA MESA CONVEXA</p>

HOW TO LEVEL YOUR TABLE

CÓMO NIVELAR SU MESA

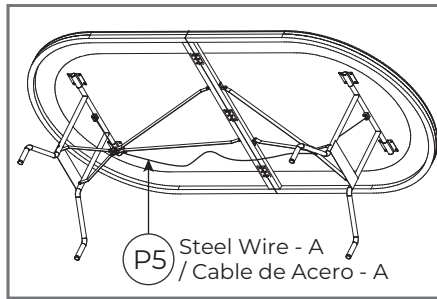
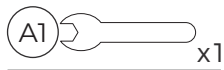

TIP

When the steel wire is too tight, place the side edge of the Table against the ground first (pay attention to protecting the product), then fold it inward and loosen the steel wire for adjustment.



CONSEJO

Cuando el cable de acero esté demasiado apretado, coloque la mesa de lado apoyada sobre el suelo (no olvide proteger el producto), luego pliéguela hacia dentro y afloje el cable de acero para ajustarlo.

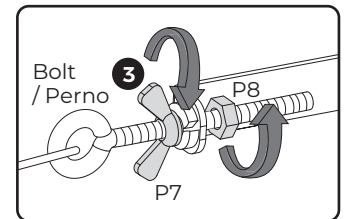
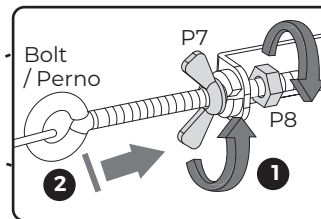
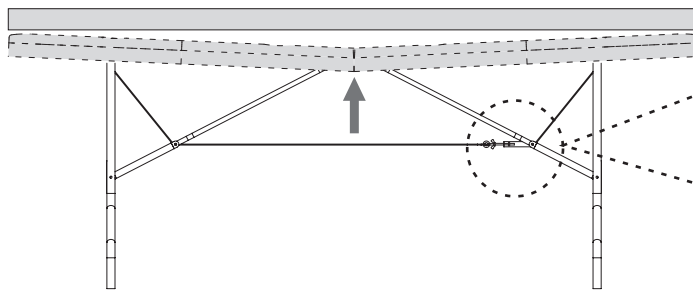

ADJUST CONCAVE TABLE

1. Loosen P7 and P8.
2. Push the Bolt inwards until the playfield is even.
3. Tighten P7 and P8.

AJUSTAR LA MESA CÓNCAVA

1. Afloje P7 y P8.
2. Empuje el Perno hacia dentro hasta que el campo esté a nivel.
3. Apriete P7 y P8.

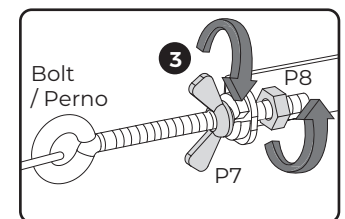
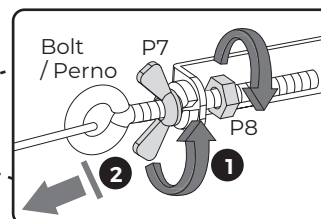
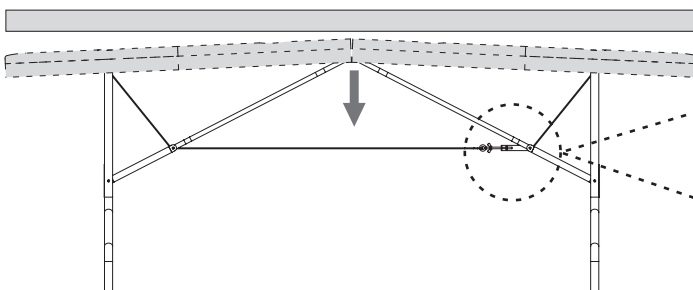

ADJUST CONVEX TABLE

1. Loosen P7 and P8.
2. Pull the Bolt outwards until the playfield is even.
3. Tighten P7 and P8.

AJUSTAR LA MESA CONVEXA

1. Afloje P7 y P8.
2. Tiras el Perno hacia fuera hasta que el campo esté a nivel.
3. Apriete P7 y P8.