

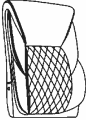











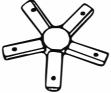

Accessories List

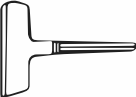
(1) Backrest 	(2) Seat Cushion 	(3) 2 Armrests 	(4) Split Base Tube 
(5) Central Base Tube 	(6) Central Base Buckle 	(7) Air Rod 	(8) 5 Castors 
(9) Hexagon Wrench 	(10) 4 Decoration Caps 	(11) Steel Plate 	(12) 5 Screws (M6×20) 
(13) 4 Screws (M8×40) 	(14) 4 Screws (M8×25) 	(15) 4 Screws (M6×25) 	

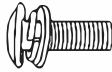
- Do not stand in this chair or use the chair as a step ladder, use it as chair only.
- This chair is designed for one person to use at a time, weighting up to 300lbs (136kg).
- Do not use this chair unless all bolts, screws and knobs are firmly secured.
- Check all bolts, screws and knobs every 90 days. Tighten them if any are loose.
- Failure to follow these instructions may result in serious injury or death of yourself and people around you.
- Some of the parts are heavy and/or have sharp edge, please install it carefully to avoid hurting you and people around you.

Instructions for Use

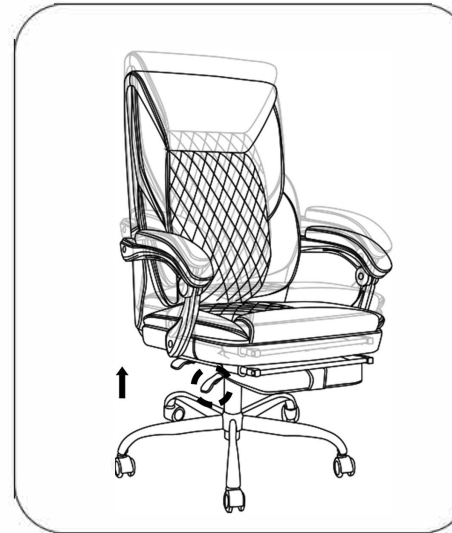

Upward adjustment



Downward adjustment

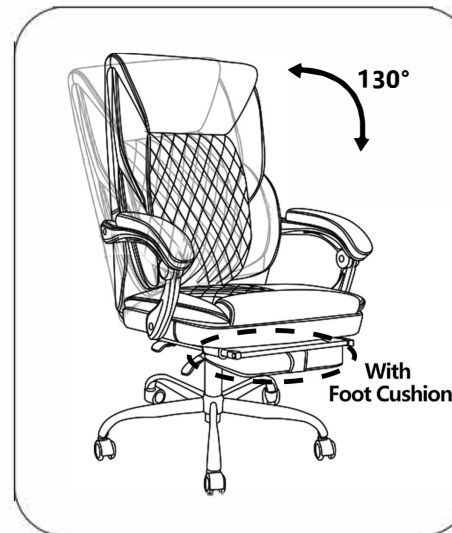

Backrest adjustment



300LB (136kg)

Thanks for purchasing our products. Please read this manual before assembly. And please assemble in order. After the assembly, keep the instruction properly. Make sure all the parts are included (15kinds in total).

Assembly Instruction

Step 1

Take out Split Base Tube (4) and Central Base Tube (5). Insert Split Base Tube (4) into Central Base Tube (5) as shown. You can see there are screw holes. Align with the holes, tighten 5 Screws (M6×20) (12) with Hexagon Wrench (9) to fix 5 Split Base Tube (5) to Central Base Tube (4).

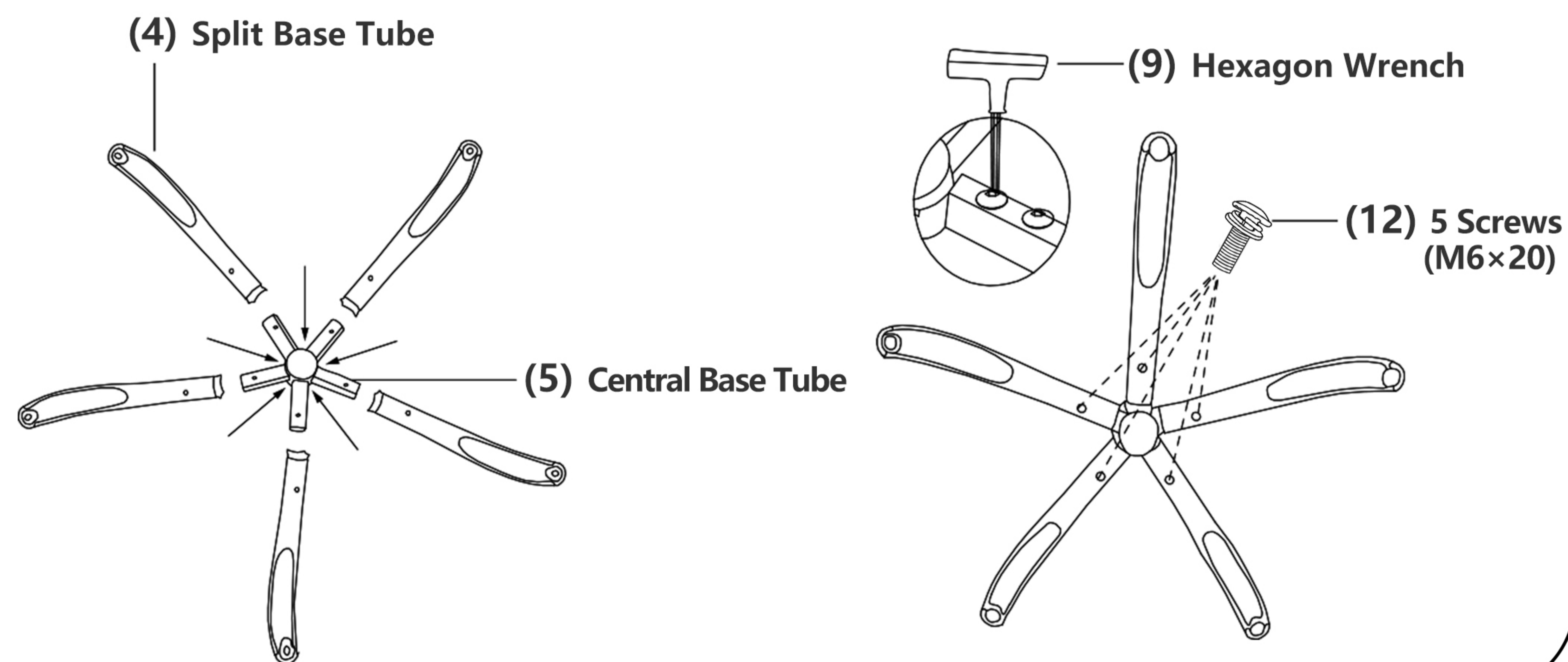

Step 2

Take out Castors (8). Insert Castors (8) into part of Step 1 as shown. There are 5 Castors (8) need to be inserted. Take out Air Rod (7). Put Air Rod (7) through Central Base Buckle (6) into the hole of Central Base Tube (5) as shown.

* Caution: Confirm Castors (8) must be inserted deeply. Otherwise the castors could easily fall out and the chair could fall down.

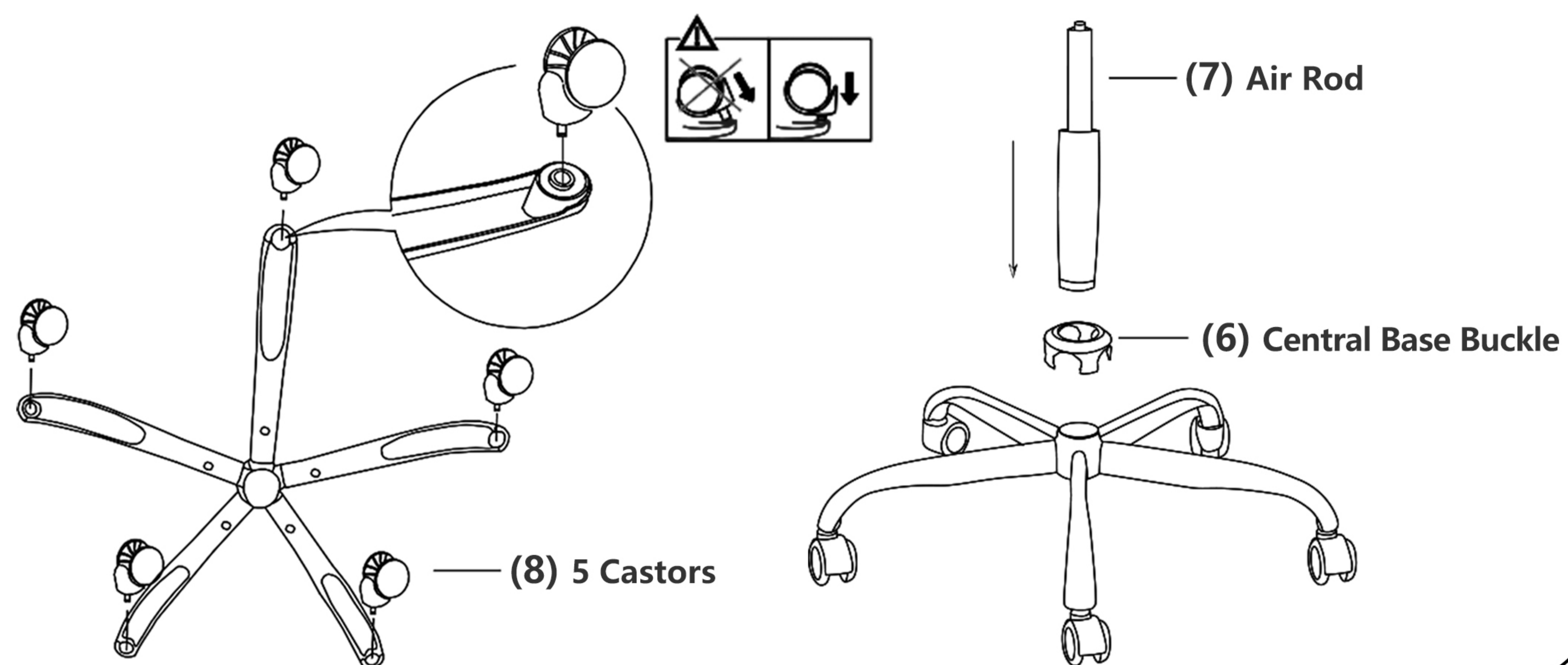

Step 3

Pick up the Air Rod (7) and the Center Base Tube (5) from step 2. Insert them into the bottom plate under the Seat Cushion (2) which has a hole in the middle. Press the Cushion (9) from top. Then connect the Backrest (1) and Steel Plate (11) and tighten the M6X25 (15) screws with Hexagon Wrench (9). Then fasten the Seat Cushion (2) with Steel Plate (11) and tighten the M8X25 (14) screw with Hexagon Wrench (9).

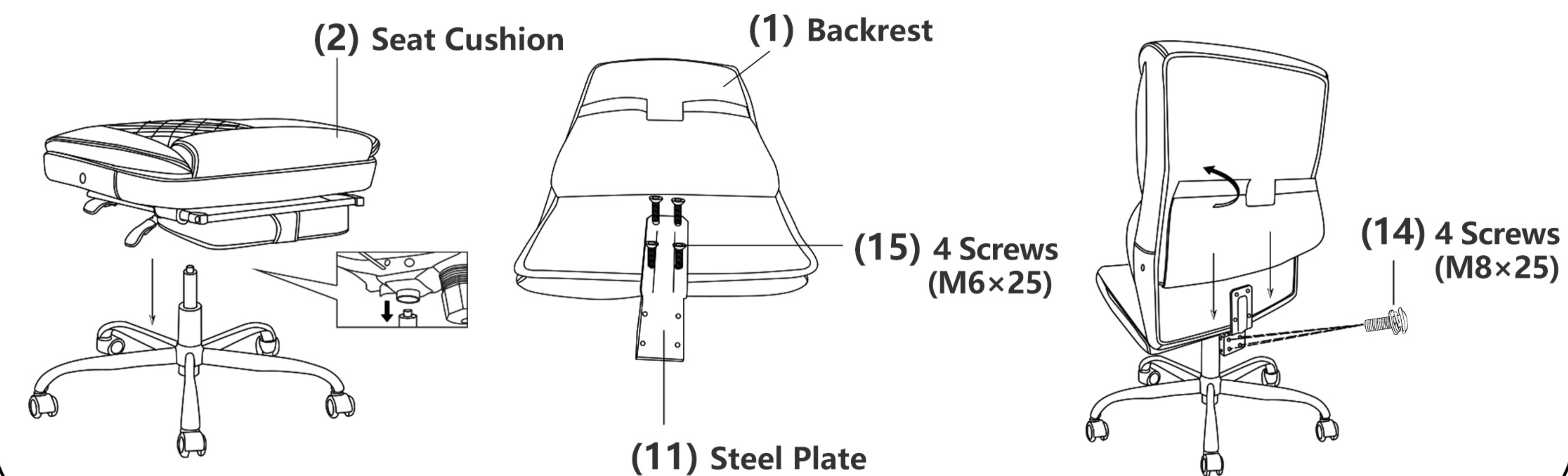

Step 4

Tighten the Screws M8X40 (13) with Hexagon Wrench (9) and fix the 2 Armrests (3) between the Backrest (1) and the Seat Cushion (2). Tighten the 4 screws firmly and then cover the screws with Decoration Caps (10). The assembly is complete now.

* Caution: When you connect the armrest with the cushion, if the hole position of the armrest is not aligned with the hole position of the cushion, please force the armrest to align with the hole position of the cushion and install the screw. After the product is fully assembled, check the screws for tightening.

