

IMPORTANT SAFETY INSTRUCTIONS

It's most important that this instruction book should be retained with the appliance for future reference. Should the appliance be sold or transferred to another owner, or should you move house and leave the appliance, always ensure that the book is supplied with the appliance in order that the new owner can be acquainted with the functioning of the appliance and the relevant warnings.

These warning are provided in the interest of safety. You must read them carefully before installing or using the appliance.

GENERAL SAFETY

The appliance is designed exclusively for domestic use. The appliance is intended to be used exclusively for the storage of the wine as explained in this instruction booklet.

WARNING

1. Risk of injury due to broken glass! The fragments have sharp edges and may cause serious injury. Take appropriate protective action.
2. This appliance is not intended for use by persons (including children) with reduced physical, sensory or mental capabilities, or lack of experience and knowledge, unless they have been given supervision or instruction concerning use of the appliance by a person responsible for their safety. Children should be supervised to ensure that they do not play with the appliance.
3. It is dangerous to alter the specifications or modify this product in any way.
4. Before any cleaning or maintenance work is carried out, be sure to switch off and unplug the appliance.
5. This appliance is heavy. Care should be taken when moving it.
6. Take utmost care when handling your appliance so as not to cause any damages to the cooling unit with consequent possible fluid leakages.
7. The appliance must not be located close to radiators or gas cookers.
8. Avoid prolonged exposure of the appliance to direct sunlight.
9. There must be adequate ventilation round the appliance and any damage to the refrigerant circuit must be avoided.
10. Do not use other electrical appliance (such as cream makers) inside of refrigerant appliance.
11. Do not store explosive substances such as aerosol cans with a flammable propellant in this appliance.

12. This appliance is intended to be use in household and similar applications such as staff kitchen areas in shops, offices and other working environments such as hotel, motel and other apartment rooms.

13. Keep burning candles lamps and other items with naked flames away from the appliance so that do not set the appliance on fire.

SERVICING

1. Any electrical work required to install this appliance should be carried out by a qualified electrician or competent person.
2. This product should be serviced by an authorized Service Center, and only genuine spare parts should be used.
3. Under no circumstances should you attempt to repair the appliance yourself. Repair carried out by inexperienced persons may cause injury or more serious malfunctioning. Refer to your local Service Center, and always insist on genuine spare parts.
4. If the power cord is damaged, it must be replaced by the manufacturer, its maintenance department or a professional in a similar department, in order to avoid danger.
5. This appliance contains hydrocarbons in its cooling unit. Maintenance and recharging must therefore only be carried out by authorized technicians.

SERVICING NOTE

This appliance employs hydrocarbon Refrigerant type R600a. It is hazardous for anyone other than an Authorized Service Person to service this appliance.

USE

1. The wine cabinet is designed to be used specifically for the storage of the potable wine only.
2. This appliance performs well within the climate class showed in the table below. It may not work properly if being left at a temperature above or below the indicated range for a long period. Refer to the information specified on the rating label for the specific climate class.

Class	Symbol	Ambient Temperature range
Subtemperate	SN	+10 °C -32 °C (50 °F -89,6 °F)

Temperate	N	+16 C-32 C (60.8 F -89.6 F)
Subtropical	ST	+16 C-38 C (60.8 F -100.4 F)
Tropical	T	+16 C-43 C (60.8 F -109.4 F)

WARNINGS:

When the ambient temperature is not included within the range indicated for the class of this appliance, the following instructions must be observed: when the ambient temperature rises up the maximum level, the storage temperature in the refrigerator cannot be guaranteed, It is advisable to use the food stored as soon as possible.

3. Do not put hot pot on the plastic parts of the appliance.
4. Do not store flammable gas and liquid in the appliance,because they may explode.
5. Do not place wine directly against the rear wall of the compartment.
6. The appliance' s manufactures storage recommendations should be strictly adhered to Refer to relevant instructions.
7. The inner lining of the appliance has channels through which the refrigerant passes. Should the channels be punctured the unit would be damaged beyond repair.

DO NOT USE SHARP INSTRUMENTS to scrape of frost or ice, Frost must be removed by using a scraper.

Under no circumstances should the solid ice be forced off the liner. Solid ice should be allowed to thaw when defrosting the appliance.

INSTALLATION

IMPORTANT: For electrical connection carefully follow the instructions given in specific paragraphs.

1. Unpack the appliance and check if there are damages on it. Do not connect the appliance if it is damaged. Report possible damages immediately to the place you bought it. In that case retain packing.
2. During normal operation, the compressor and/or condenser at the back of the appliance heat up considerably. For safety reasons, minimum ventilation must be as shown in the instructions.

ATTENTION: Keep ventilation opening clear of obstruction.

3. Care must be taken to ensure that the appliance does not stand on the electrical supply cable.

IMPORTANT: If the supply cord is damaged,it must be replaced by a special cord or assembly available from the manufacture or its service agent

4. If the appliance is transported horizontally, it is possible that the oil contained in the compressor flows in the refrigerant circuit. It is advisable to wait at least two hours before connecting the appliance to allow the oil to flow back in the compressor.

ELECTRICAL CONNECTION

1. Before plugging in, ensure that the voltage and frequency shown on the serial number plate correspond to your domestic power supply. Voltage can vary by $\pm 6\%$ of the rated voltage.
2. The appliance must be earthed. The power supply cable plug is provided with a contact for this purpose. The power socket must have an earth connection in line with electrical safety regulations.
3. The manufacturer declines all responsibility if the above safety precaution are not observed.

CLEANING THE INTERIOR

Before using the appliance for the first time, wash the interior and all internal accessories with lukewarm water and some neutral soap so as to remove the typical smell of a brand-new product,and then dry naturally and thoroughly.

 DO not use detergents or abrasive powders as these will damage the finish.

INSTALLING YOUR APPLIANCE

Before using the appliance for the first time, you should be informed of the following tips.

WARNING: For proper installation, the appliance must be placed on a level surface of hard material that is the same height as the rest of the flooring. This surface should be strong enough to support a fully loaded appliance.

 In order to improve efficiency of the cooling system and save energy, It is necessary to maintain good ventilation around the appliance for the dissipation of heat. For this reason, sufficient clear space should be available around the product.

SUGGESTION: It is advisable for there to be at least 2 inch of space from the back to the wall, at least 4 inch from its side to the wall. As shown in follow diagrams.

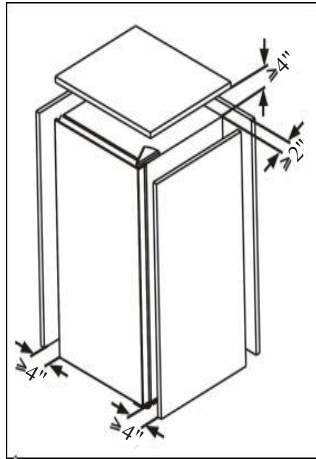

NOTES:

1. Avoid locating the appliance in damp areas. Too much moisture in the air will cause frost quickly on the evaporator.
2. Keep the appliance out of direct sunlight, rain or frost. Stand the product away from heat sources such as stoves, fires or heaters.
3. The glass door of the appliance is fragile. Front collision should be banned when you open it.
4. The opening angle for the door ranges between 90°C -130°C (194°F -266°F), under which the shelf can be pulled out properly. Do not open the door excessively to avoid causing damage to the door.
5. Plug the appliance into an exclusive properly installed, grounded wall outlet. Do not under any circumstances cut or remove the third (ground) prong from the power cord. Any question concerning power and/or grounding should be directed towards a certified electrician or an authorized products service center.

LEVELING OF APPLIANCE

For sufficient leaving and air circulation in the lower rear section of the appliance, the leveling leg may need to be adjusted. You can adjust them manually by hand or by using a suitable spanner.

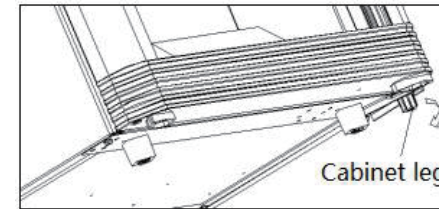

DESCRIPTION OF THE APPLIANCE

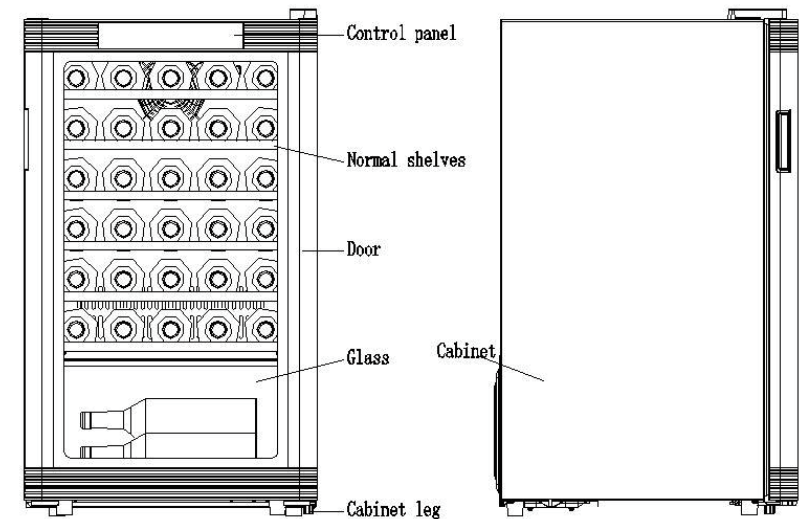

NOTES:

1. 65L wine cooler can store 18 bottles of wine at the same time, please place wine bottles as shown above.
2. The bottle capacity described in this manual is based on BORDEAUX 750ml bottles and standard shelving.

CONTROL PANEL

The control panel, showed blow, is arranged on the door.

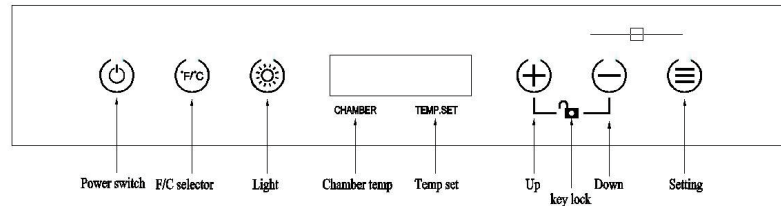

You can use you appliance according to the following control guidelines.

Power switch

To turn on/off this appliance. To turn on the appliance, hold and press the  for 3 seconds.

F/°C Selector

Choose to display temperature setting in Fahrenheit or Celsius.

Light

To turn on/off the interior light.

Chamber temp display

To indicate the temperature of chamber

Temp set display

To indicate the set temperature

UP



To increase the set temperature by 1°C/°F.

DOWN

To decrease the set temperature by 1°C/°F.

Key lock

If in 10 seconds without touching any key, the controls will be locked automatically.

To release the lock, touch the “” and “” at the same time for at least 3 seconds.

Setting

You can set the internal temperatures as desired by touching the “UP” or “DOWN” buttons, but at first you should touch the **Setting button** .

1. **Chamber temp:** actual temperature in the chamber

2. **Set temp :** The temperature is recommended to be set at 5°C-18°C/ 41°F-64°F.

Alarm function

Door-open alarm function

Automatically alarm when the door is not closed within 60 seconds (alarm sounds “Beep”, every 3 seconds) The alarm will be automatically cancelled after closing the door (you can also press any key to cancel the alarm sound).

Over-temperature alarm function

When the door is closed, if the temperature inside the chamber is greater than 20 C (68 F) for 12 consecutive hours, an over-temperature alarm prompts a “beep” sound, once every 3 seconds, and if the displayed temperature in the upper and lower temperature areas \leq the set temperature, the alarm is canceled (you can also long press the setting key for 3 seconds to cancel the alarm sound).

If the product is a WIFI smart model: see Smart Wine Cooler APP Function Manual

NOTES:

1. When the appliance is used for the first time or restarted after having been shut off for a long time, there could be a few degrees variance between the temperature you select and the one indicated on this display. This is normal and it is due to the length off the inactivation time.
2. When you set a temperature, you set an average temperature for the whole cabinet. There may be a 3 C-5 C (37.4 F -41 F) variance between the top and bottom shelves of the appliance.

USING YOUR APPLIANCE

This section tells you how to use most of the useful features. We recommend that you read through them carefully before using the appliance.

PLACEMENT OF BOTTLES

The 65L wine cooler is equipped with 3 shelves. Each shelf holds 5 bottles of wine. The wine bottles should be placed on the shelves, as shown in the figure. Three bottles of wine can be placed on the bottom of the appliance as shown.

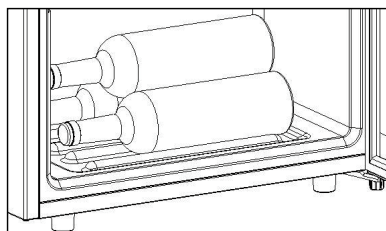
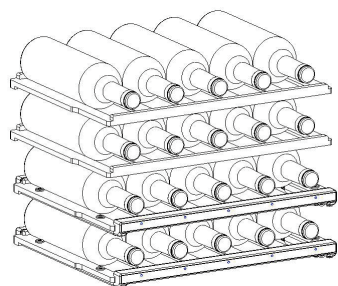

WARNING! The maximum loading of each type of shelf is 7.5kg (16.5 lbs.).

INSTRUCTION FOR FETCHING WINE

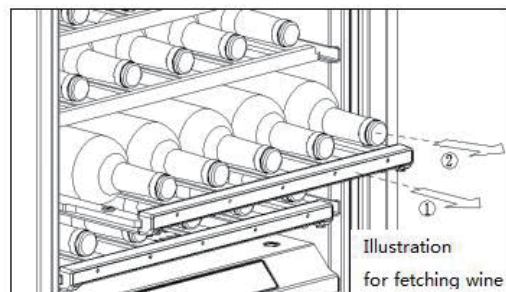

Refer to the above “Illustration for fetching wine” when need to fetch the wine. Firstly, pull the shelf forwards until the shelf①reaches the stop position, and then fetch the wine②from the shelf, and finally push the shelf①back to the original position.

TIPS FOR KEEPING THE WINE

1. Keep the wine in the dark. The door adopts anti-UV darkened double glass to protect the wine from the light in case the refrigerator is located in a well-lit place.
2. Lay the bottles down in such a way that the corks do not dry.
3. Avoid switching the appliance light on too often or for too long. Wine keeps better in dark.
4. To avoid agitating the wine, handle the bottles with care.
5. Follow the recommendations and advice at the time of purchase or given in the technical documentation regarding the quality, duration and optimum storage

temperature of the wine.

6. The storage for wine depends on age, the type of grapes, alcoholic content and level for fructose and tannin contained in it. At the time of purchase, check if the wine is already aged or if it will improve over time.

7. Do not store explosive substances such as aerosol cans with a flammable propellant in this appliance.

WINE STORAGE TEMPERATURE CHART

All wine mature at the same temperature, which is a constant temperature set between 12 °C-14 °C (53.6 °F -57.2 °F), the below chart is an indicative temperature chart to indicate the best temperature for drinking purposes.

Types of wine	Recommended temperature
Champagne NV, Sparkling, Spumante	6 °C (42.8 °F)
Dry white Semillon, Sauvign Blanc	8 °C (46.4 °F)
Champagne Vintage Dry White Chardonnay Barsac Ice Wine, Late Harvest	13 °C (55.4 °F)
Sweet White Vintage	14 °C (57.2 °F)
Red Pinot Noir Red Grenache, Syrah	16 °C (60.8 °F)
Red vintage Pinot Noir	18 °C (64.4 °F)

CARE AND MAINTENANCE

REMOVING SHELVES

Firstly, lift the rear of shelf upwards (see①), and then pull the shelf out of the cabinet (see②).

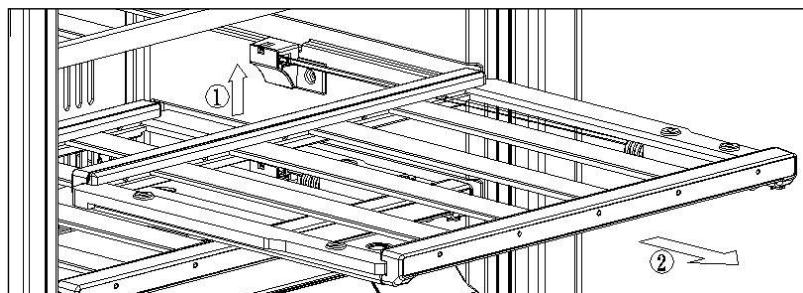

INSTALLING SHELVES

Follow the reverse operation of “REMOVING SHELVES”.

CLEANING YOUR APPLIANCE

1. Turn off the power, unplug the appliance, and remove all items including shelves.
2. Wipe the interior with a warm water and baking soda solution. The solution should be about 2 tablespoons of baking soda to one quart of water.
3. Wipe the shelves with a mild detergent solution.
4. Wipe the outside cabinet with warm water and mild liquid detergent.

CAUTION: Failure to unplug the appliance could result in electrical shock or personal injury

PERMISSION POWER FAILURE

Most power failures are corrected within a few hours and should not affect the temperature of your appliance if you minimize the number of times the door is opened. If the power is going to be out for an extended period of time, you need to take the proper steps to protect your content.

NORMAL PHENOMENA

1. **External condensation:** In a high-humidity environment, the condensation on the outer surface of the cabinet is a normal phenomenon, and it can be wiped off with a soft cloth.
2. When the Wine Cooler is started for the first time, the cooling time will be longer, that is because the temperature inside the cabinet is higher.

3. The temperature of the compressor surface will be higher when the compressor is working normally, which is a normal phenomenon. Do not touch the compressor surface by hand. And the temperature for the external surface of the cabinet will rise because of the cooling and heat dissipation on it, which is also a normal phenomenon.

VACATION TIME

1. **Short vacation:** Leave the appliance operating during vacation of less than two days.
2. **Long vacation:** If the appliance will not be used for an extended period, remove all items and turn off the appliance. Clean and dry the interior thoroughly.

MOVING YOUR APPLIANCE

1. Remove all items inside the appliance.
2. Securely tape down all loose items (shelves) inside your appliance.
3. Turn the adjustable leg up to the base to avoid damage.
4. Tape the door shut.
5. Be sure the appliance stays secure in the upright position during transportation and protect the exterior of appliance with a blanket, or similar item.

ENERGY SAVING TIPS

1. The appliance should be located in the coolest area of the room, away from heat producing appliance, and out of direct sunlight.
2. Ensure the appliance is adequately ventilated. Never obstruct the air vents.
3. Close the door tightly and do not open the appliance too frequently or for a long period of time.
4. **WARNING:** To avoid a hazard due to instability of the appliance, it must be fixed in accordance with the instructions. (For fixed appliances (built-in)).

TROUBLESHOOTING GUIDE

Most common problems can be resolved by referring to the troubleshooting suggestions listed below.

Problem	Possible Cause
---------	----------------

Wine Cooler does not operate.	<ul style="list-style-type: none"> ● Not plugged in. ● Power failure. ● The circuit breaker tripped or a blown fuse.
Wine Cooler is not cold enough.	<ul style="list-style-type: none"> ● Check the temperature control setting. ● The temperature of external environment is too high. ● The door is opened too often. ● The door is not closed completely. ● There is not enough space from the back and side of the cabinet to the wall.
Turns on and off frequently	<ul style="list-style-type: none"> ● The room temperature is hotter than normal. ● A large amount of contents has been added to the Wine Cooler. ● The door is opened too often. ● The door is not closed completely. ● The temperature control is not set correctly. ● There is not enough space from the back and side of the cabinet to the wall.
The light does not work	<ul style="list-style-type: none"> ● Not plugged in. ● The circuit breaker tripped or a blown fuse. ● The light switch is "OFF"
Vibrations	<ul style="list-style-type: none"> ● Check to ensure that the Wine Cooler is level.
The Wine Cooler seems to make too much noise	<ul style="list-style-type: none"> ● The rattling noise may come from the flow of the refrigerant, which is normal. As each cycle ends, you may hear gurgling sounds caused by the flow of refrigerant in your Wine Cooler. ● Contraction and expansion of the inside walls may cause popping and crackling noises. ● The Wine Cooler is not level.
The door will not close properly	<ul style="list-style-type: none"> ● The Wine Cooler is not level. ● The door was reversed and not properly installed. ● The door sealing is dirty. ● The shelves are out of position.
Display "EL" or "EH"	<ul style="list-style-type: none"> ● The error code "EH" will be displayed when the sensor is short-circuited or the temperature

	<p>displayed exceeds 50°C/122°F.</p> <ul style="list-style-type: none"> ● The error code "EL" will be displayed when the sensor is open-circuited or the temperature displayed is lower than -9°C/16 °F.
--	---

DISPOSAL OF THE APPLIANCE

It is prohibited to dispose of this appliance as household waste.

WARNING! When disposing of your appliance, use an authorized disposal site.

Remove the plug and ensure that any locks or catches are removed, to prevent young children being trapped inside.

PACKAGING MATERIALS

Packaging materials with the recycle symbol are recyclable. Dispose of the packing into a suitable waste collection container to recycle it.

BEFORE DISPOSAL OF THE APPLIANCE

1.Pull the mains plug from the mains socket.

2.Disconnect the power cord and discard it with the power plug.

WARNING! Refrigerators contain refrigerant and gases in the insulation. Refrigerant and gases must be disposed of professionally as they may cause eye injuries or ignition. Ensure that tubing of the refrigerant circuit is not damaged prior to proper disposal.

WARNING:

1.Since the refrigerant used in this equipment is a flammable gas (isobutane R600a), please pay special attention to ensure that the refrigerant circuit and pipeline are not be damaged during transportation and installation.

2. If refrigerant circuits and piping are damaged ,keep equipment away from sparks and ensure good ventilation in the room. Cut off the power supply and contact your dealer immediately.

3.Keep ventilation openings, in the appliance enclosure or in the built-in structure, clear of obstruction.

4.Do not use mechanical devices or other means to accelerate the defrosting process, other than those recommended by the manufacturer.

5.Do not use electrical appliances inside the food storage compartments of the appliance, unless they are of the type recommended by the manufacturer.

DANGER: Risk of child entrapment. Before you throw away your old refrigerator or

freezer: Take off the doors and Leave the shelves in place so that children may not easily climb inside.

RECYCLE:

1. The equipment contains recyclable equipment. When recycling, please cut off the power supply and remove the door frame to prevent children from being hurt while playing.

2. Comply with recycling laws and regulations. When dealing with equipment, contact the local resource technology department for advice on how to recycle and reuse such equipment.

NOTE: Please read the instruction carefully before use. The installation, operation safety and maintenance are detailed in the instruction. Please keep the instruction properly for future reference.