

Double Egg Swing Chair

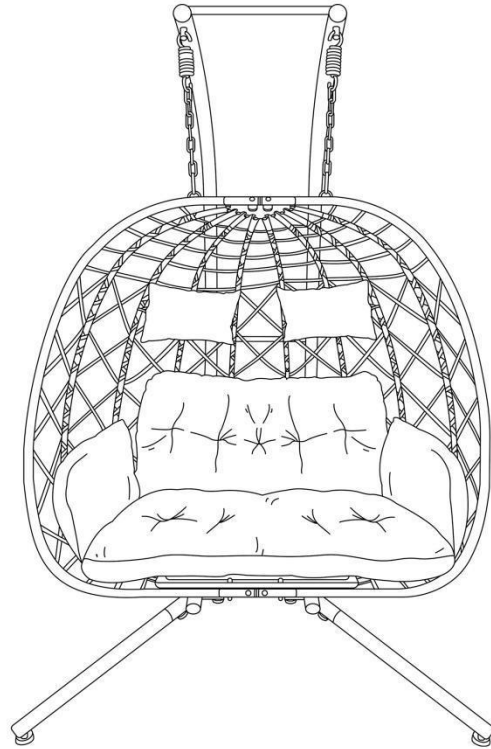









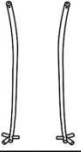

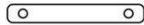



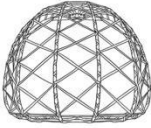
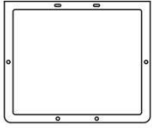



Installation Instructions



**EASY
ASSEMBLY**

Assemble in
25 minutes
or less

Parts List

Parts List										
Chair Components										
	A-left	A-right	B	2	C	4	D	1	E	1
									 reinforcement	
	F	1	G	1	H	1	I	1	J	6
			 height adjuster							
	L	2	N	4	O	2	P	2	Q	2
Accessories & Tools	M-6 		M-6  M-8  							
	R	2	S	1	M-8,60mm	2	M-8,20mm	4	M-6,40mm	10

Step 1:

Screw the 4 height adjusters (H) into the ends of the 4 support legs (C)

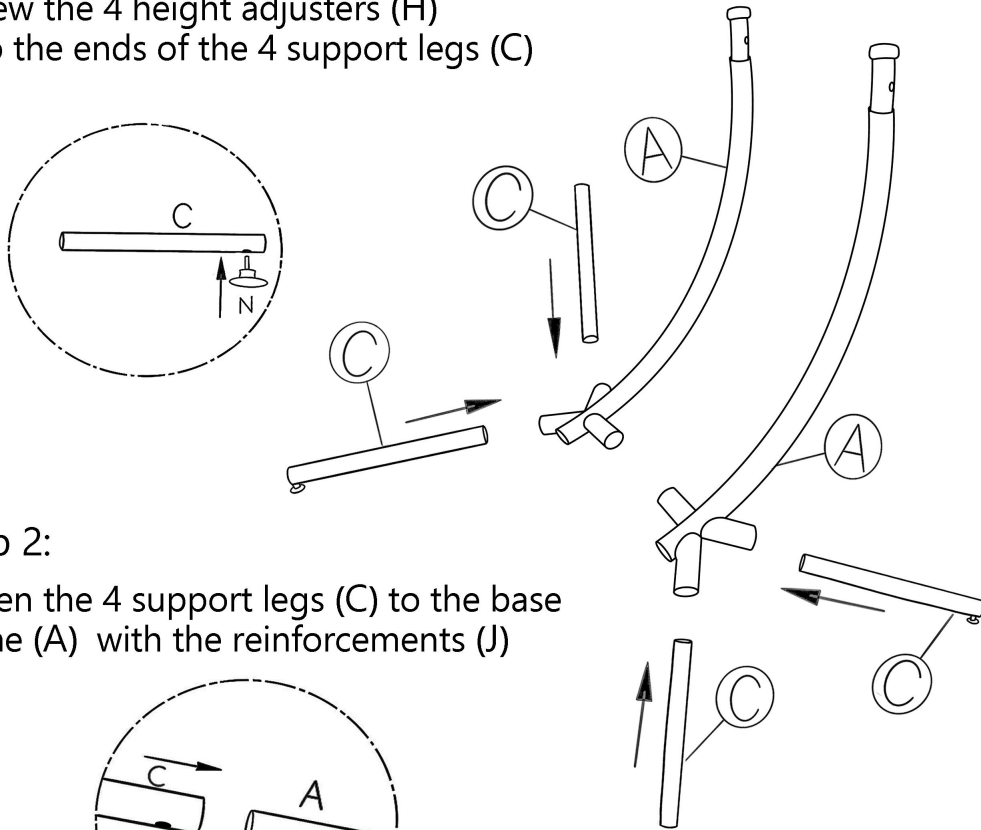

Step 2:

Fasten the 4 support legs (C) to the base frame (A) with the reinforcements (J)

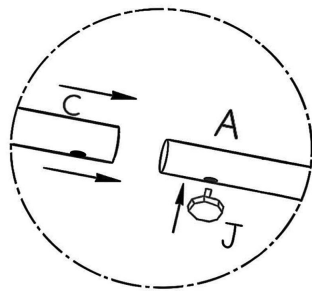

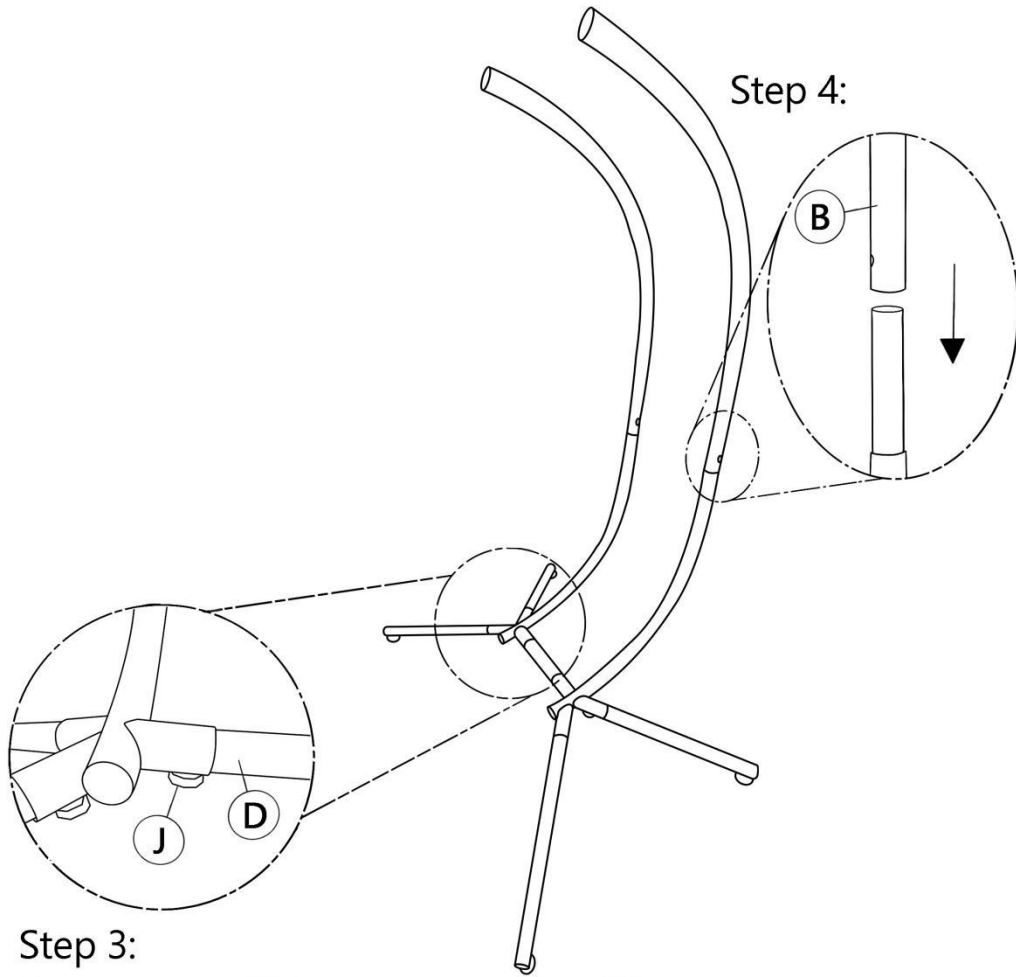

Step 3:

Use accessory (J) to secure accessory (D) to the chair frame (A).

Step 5:
Use two screws (M-8,60mm)
to secure accessories (B) and (E).

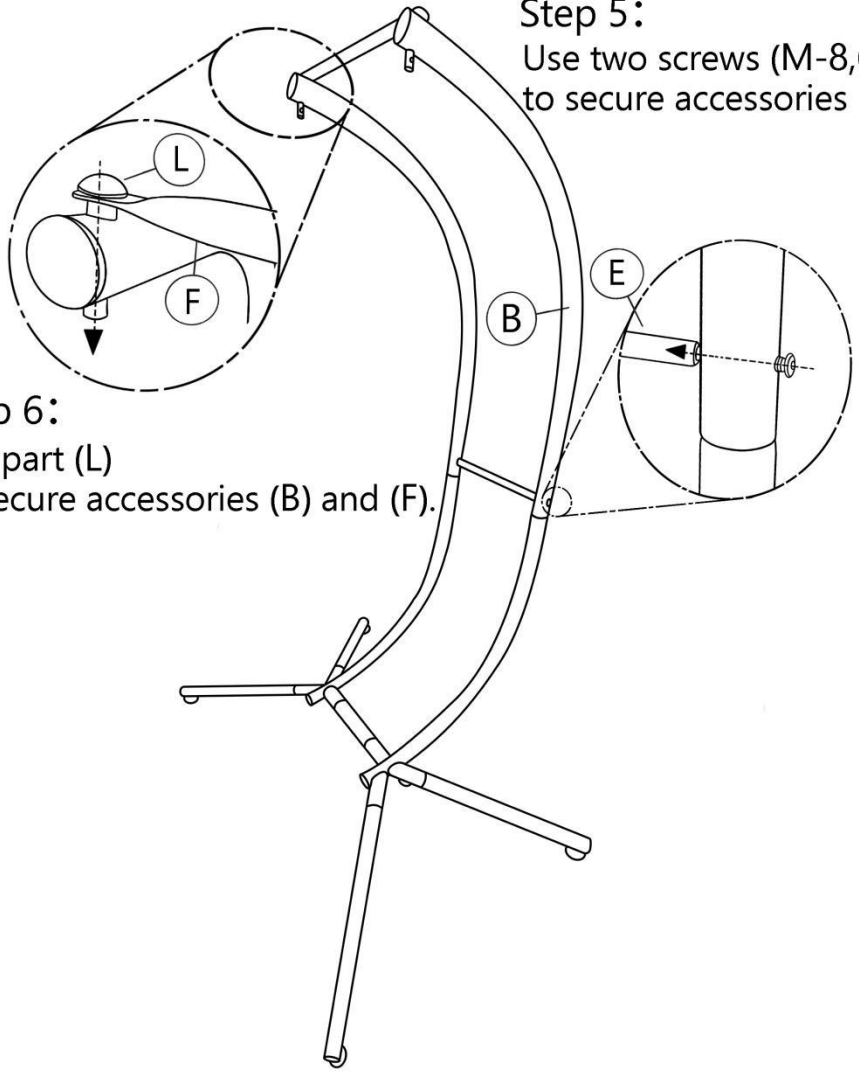

Step 6:
Use part (L)
to secure accessories (B) and (F).

Step 7: Simply flip the chair base (H) over.

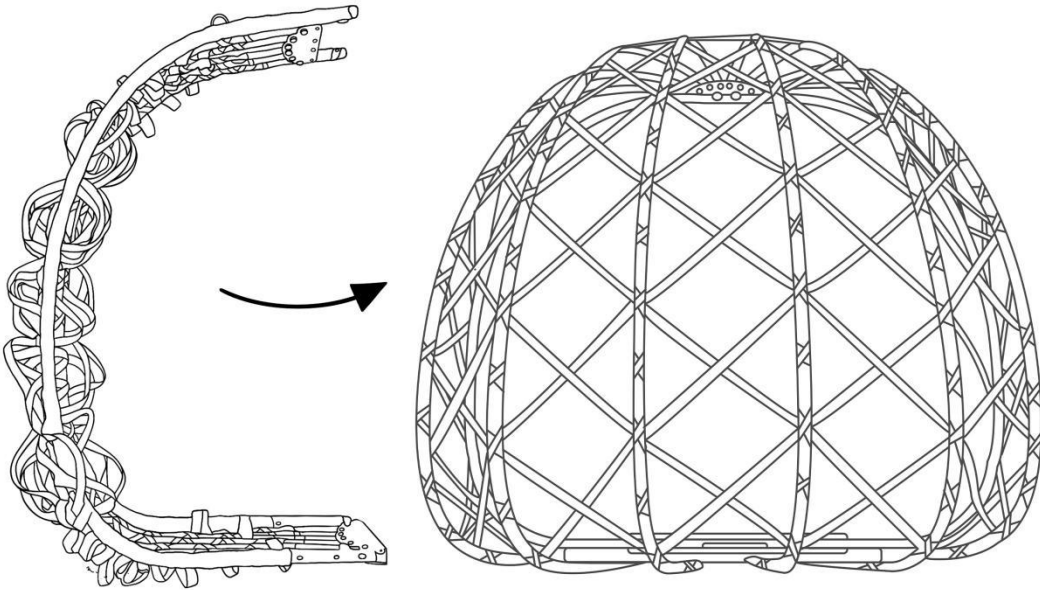

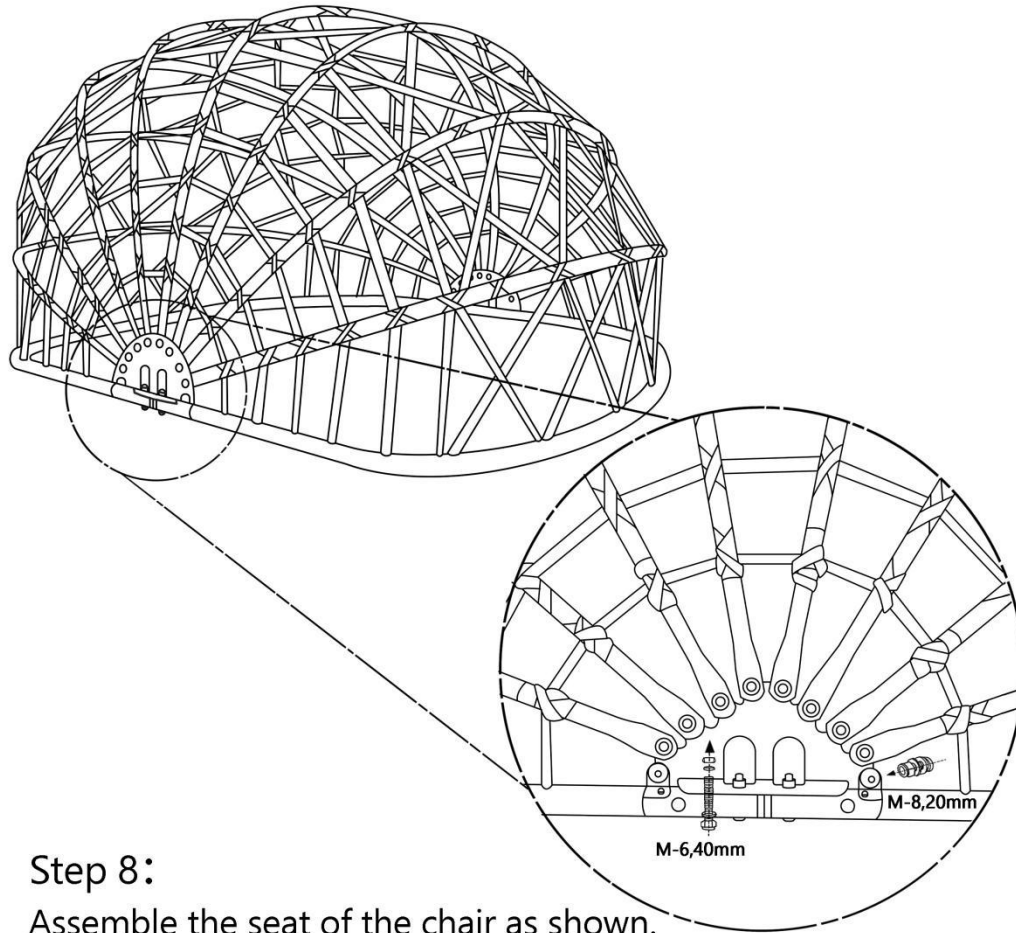

Step 8:
Assemble the seat of the chair as shown.

Installation of 2 (M-8,20mm), 2 (M-6,40mm)

Step 9:

Installation of 2 (M-8,20mm)

2 (M-6,40mm)

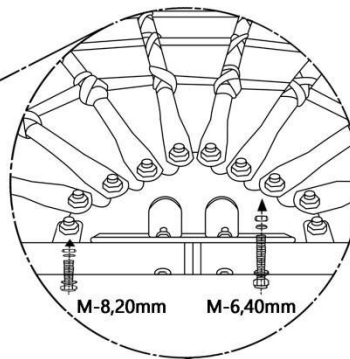
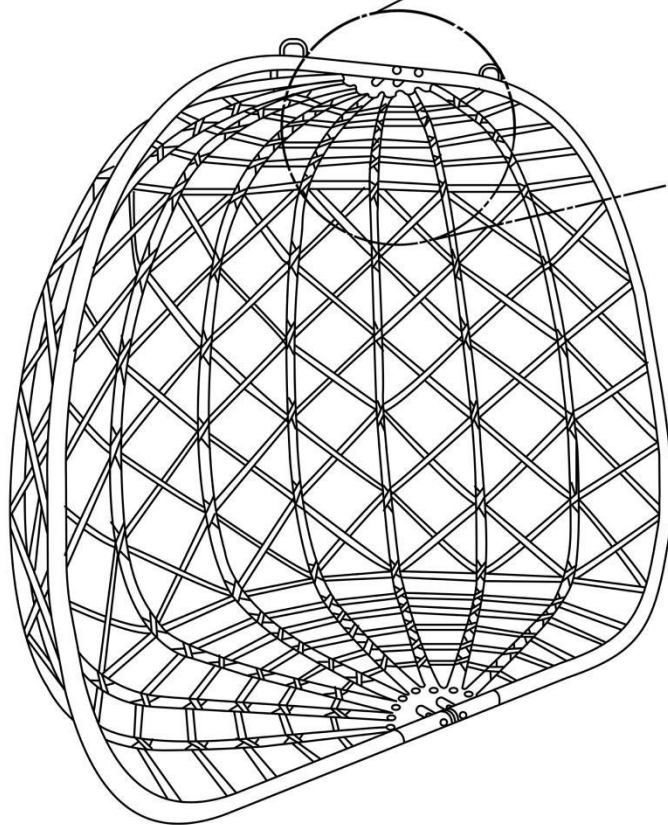

Step 10:

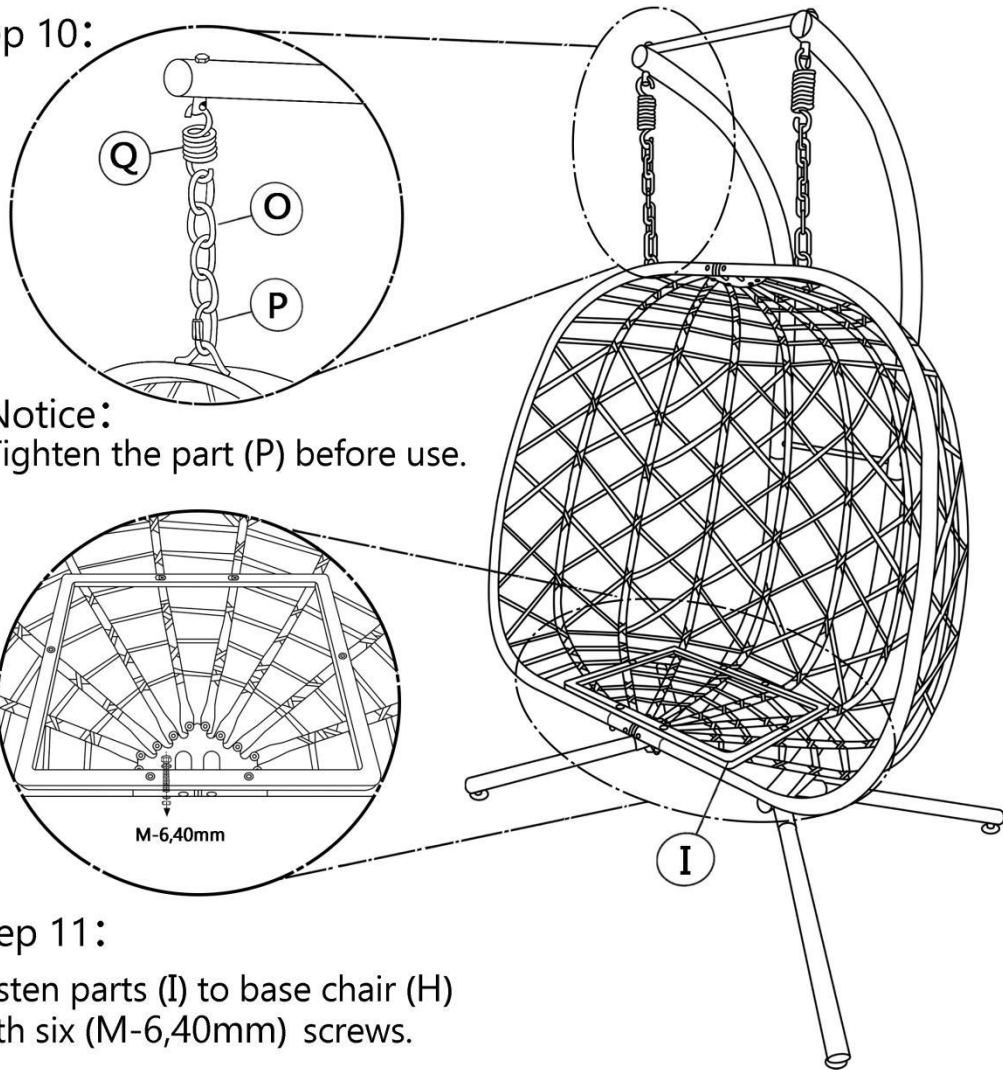

Notice:
Tighten the part (P) before use.

Step 11:

Fasten parts (I) to base chair (H)
with six (M-6,40mm) screws.

