

Project:

Spec Sheet

Description: Bring definition and architectural interest to outdoor sites and along paths or planted beds, with bollards of perfect solid geometry and LED lighting functionality. Offer a broad range of configurations, with many available options for lenses, caps, and heights for a variety of LED illuminating possibilities. Also available as a [Bollard](#), [Downlight Sconce](#), [Up/Down Sconce](#), and [Surface Mount](#).

Type #:

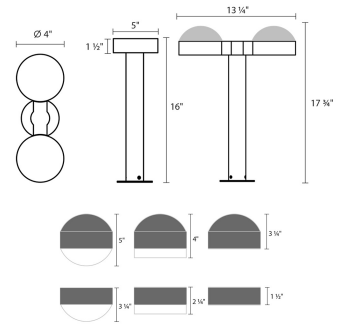

Dimensions

Height:	16"
Width:	5"
Length:	13.5"
Canopy/Backplate/Base:	4"
Size:	16"
Canopy/Backplate/Base Height:	0.25

Electrical Specs

Bulb(s) Included?:	Yes
Bulb 1 Type:	Integral LED
Bulb Quantity:	2
Input Voltage:	12VAC
Wattage:	20
Initial Lumens:	2080
Color Temperature:	3000K
CRI:	90
Power Supply Type:	Transformer
Power Supply Location:	Remote (Sold Separately)
Dimming Type:	Non-dimmable
Bulb Max Wattage:	20

Installation

Installation:	Licensed electrician required
---------------	-------------------------------

Shipping

Carton 1 L x W x H:	23" X 17" X 9"
Carton 1 Gross Weight:	9 LBS
Fixture Weight:	6

Shade

Lens Type:	Plate Caps and Clear Cylinder Lenses
Shade 1 Material:	Clear Polycarbonate

Available Finishes

Available Finishes: Textured Bronze (.72), Textured Gray (.74)

General Listings

Features:	Wet Rated
Certification:	C-ETL-US
Color/Finish:	Textured Bronze (.72)
Dark Sky Friendly:	N