

# ASSEMBLY INSTRUCTION

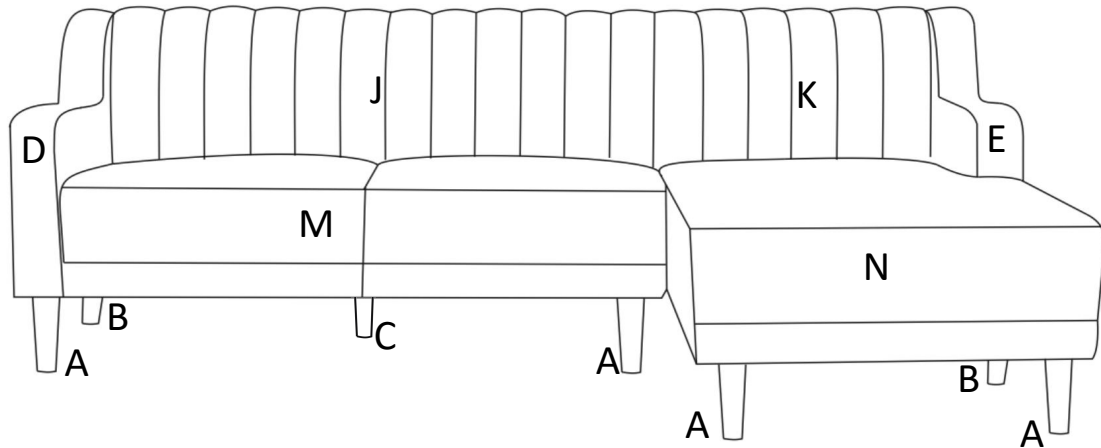

A:Legs 5PCS



B:Legs 4PCS

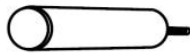

C:Legs 1PC



D:Left arm 1PC



E:Right arm 1PC



F:Bolt 4PCS



G:Washer 4PCS



H:Allen Key 2PCS

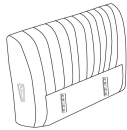

J:Back frame 1PC

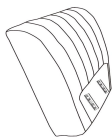

K:Back frame 1PC



M:Body 1PC



N:Body 1PC

Ax2,BX2,Cx1,Fx2,Gx2,Hx1  
Packed In The Bottom

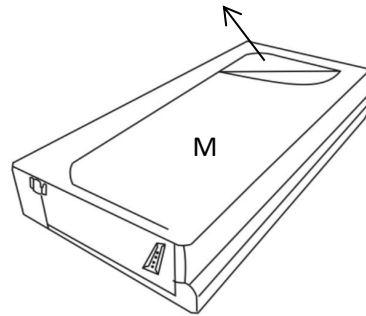

Ax3,BX2,Fx2,Gx2,Hx1  
Packed In The Bottom

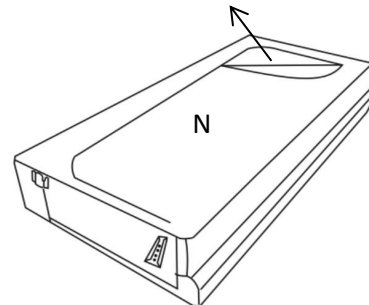

STEP 1

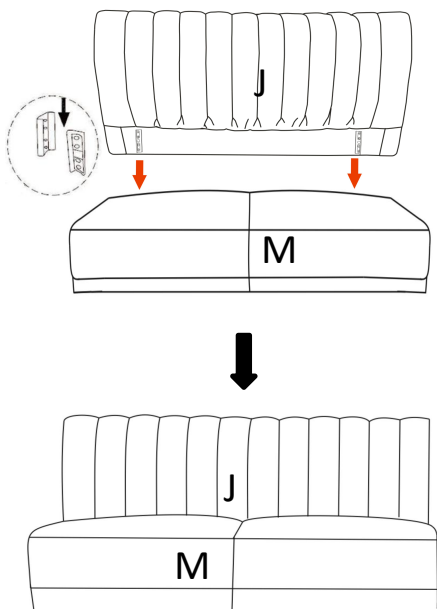

STEP 2

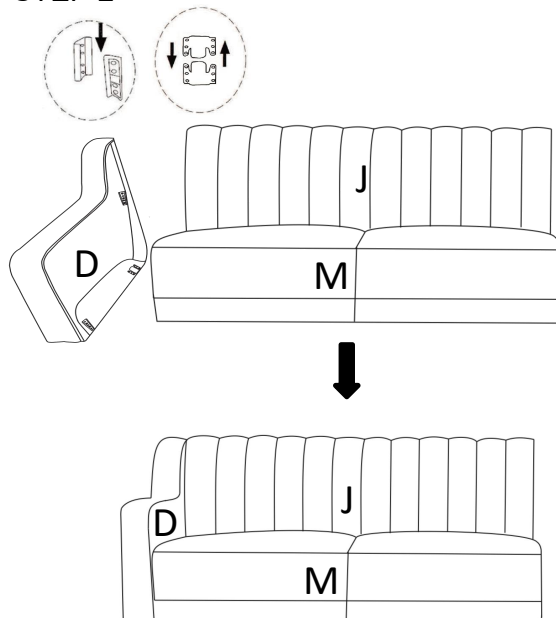

STEP 3

same assembly as step 1 and step 2

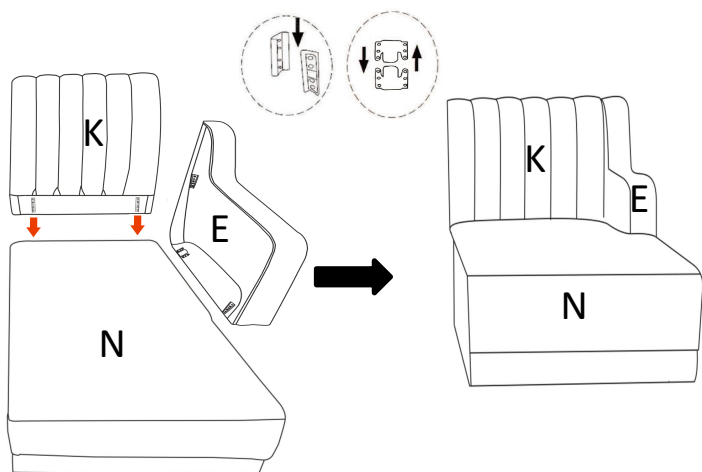

STEP 4

- 1) Turn the legs A&C clockwise to fixed it on the sofa.
- 2) Use the spare parts FGH to fixed the legs B on the sofa.

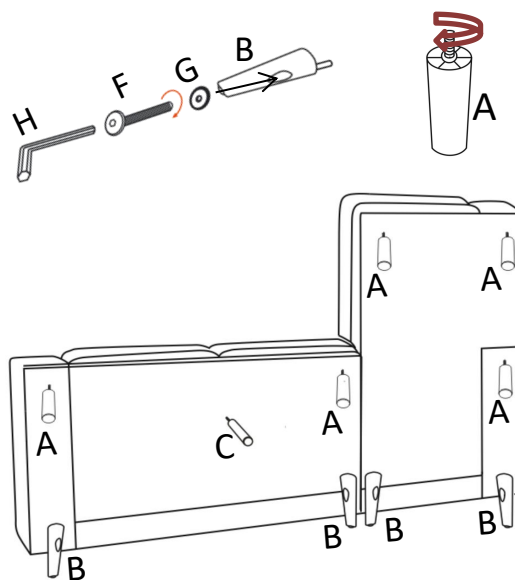

STEP 5

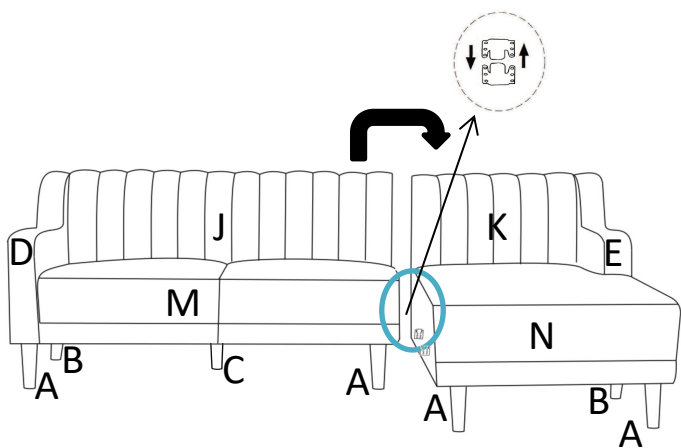

STEP 6

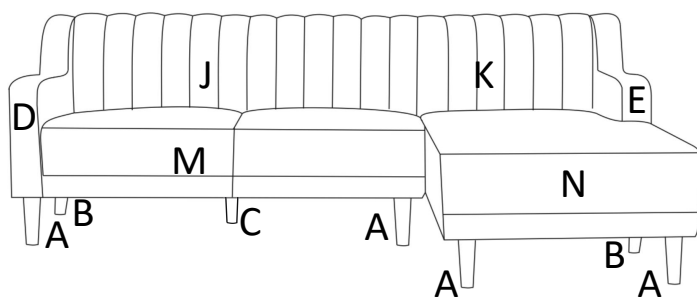

# ASSEMBLY INSTRUCTION

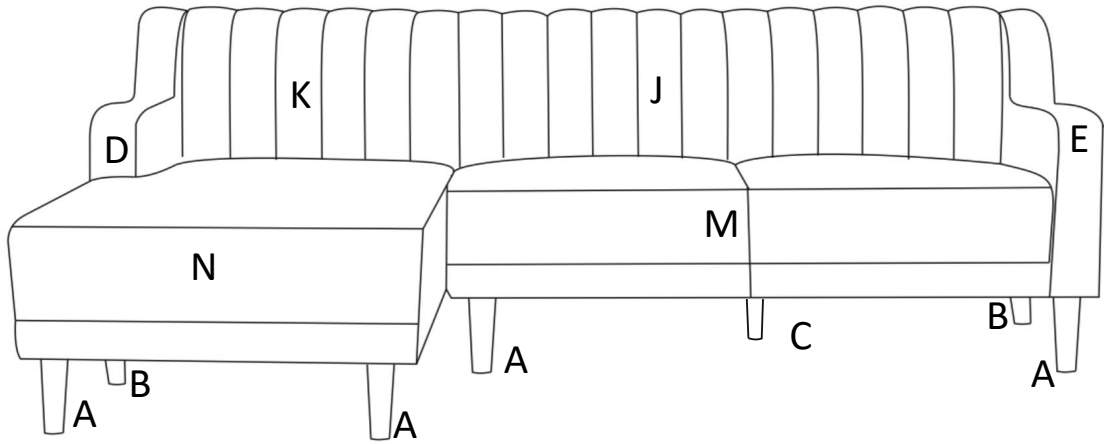

A:Legs 5PCS



B:Legs 4PCS



C:Legs 1PC



D:Left arm 1PC

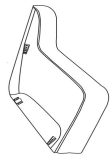

E:Right arm 1PC



F:Bolt 4PCS



G:Washer 4PCS



H:Allen Key 2PCS

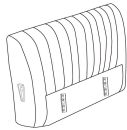

J:Back frame 1PC

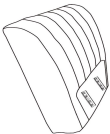

K:Back frame 1PC



M:Body 1PC



N:Body 1PC

Ax2,BX2,Cx1,Fx2,Gx2,Hx1  
Packed In The Bottom

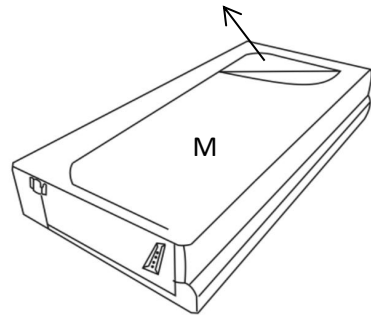

Ax3,BX2,Fx2,Gx2,Hx1  
Packed In The Bottom

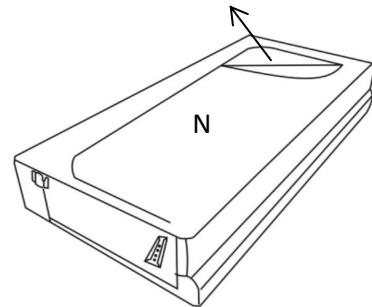

STEP 1

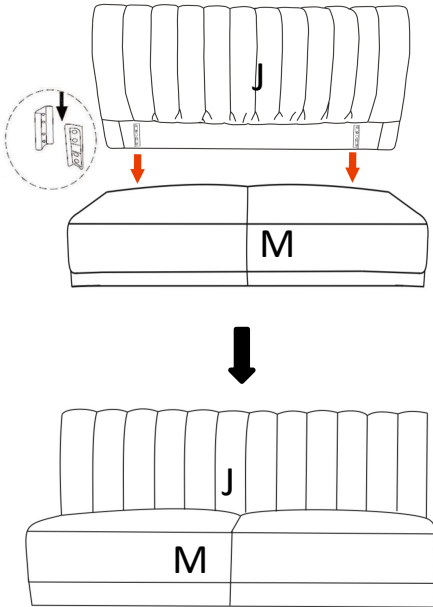

STEP 2

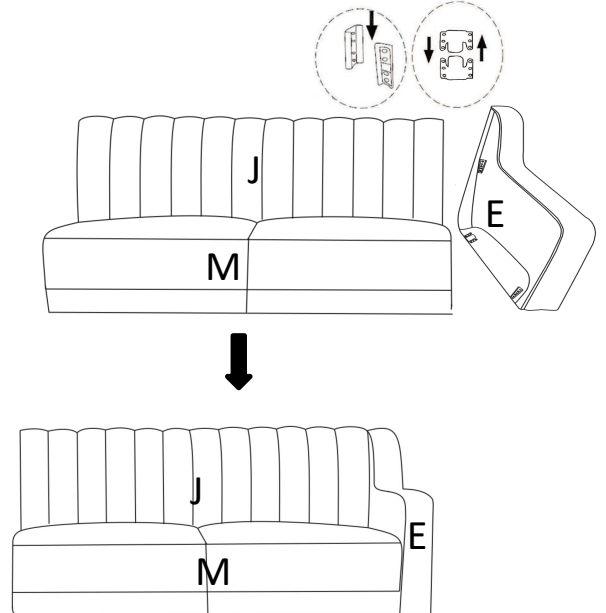

STEP 3

same assembly as step 1 and step 2

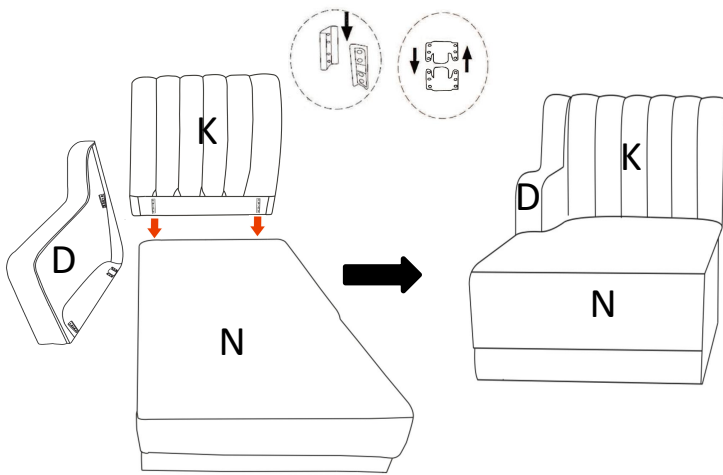

STEP 4

- 1) Turn the legs A&C clockwise to fix it on the sofa.
- 2) Use the spare parts FGH to fix the legs B on the sofa.

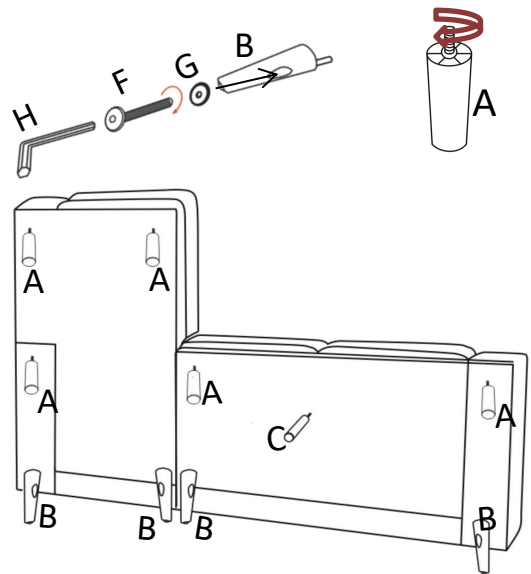

STEP 5

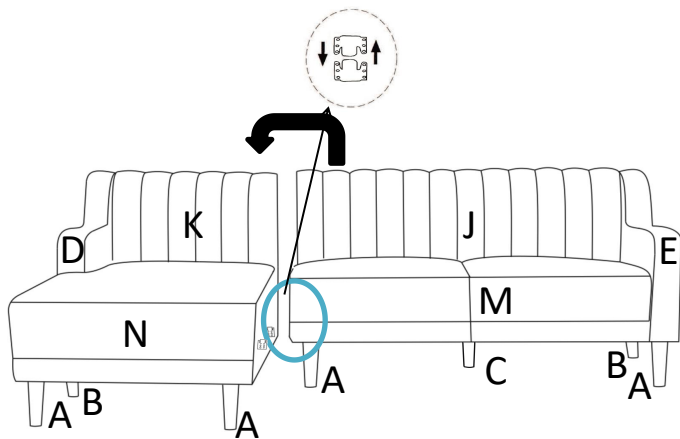

STEP 6

