

# ASSEMBLY INSTRUCTION

**A** Wood Top

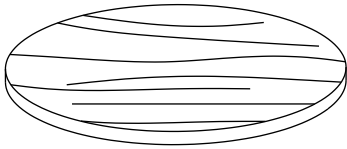

1pc

**B** Upper Side Panel

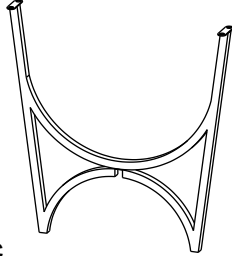

1pc

**C** Under Side Panel

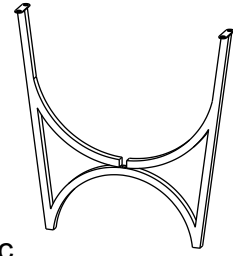

1pc

**D** Bolt  
1/4" x 1/2"

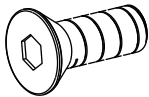

8pcs

**E** Bolt  
1/4" x 1-1/4"

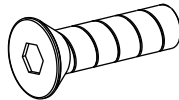

1pc

**F** Allen Wrench  
1/4"

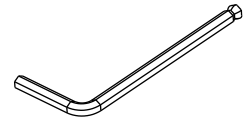

1pc

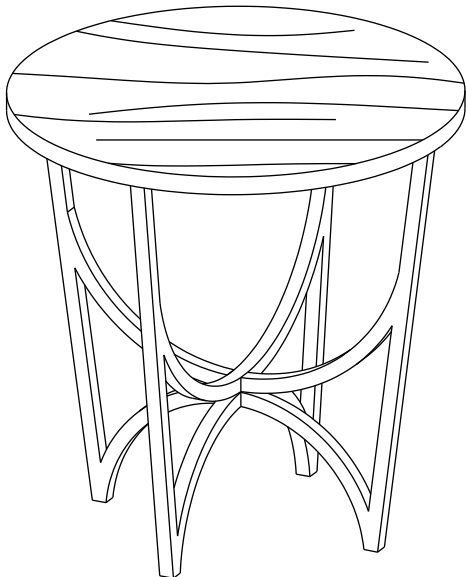

This page lists all the contents included in the box. Please take the time to identify the hardware as well as the individual components to this product. As you unpack and prepare for assembly, place the contents on a carpeted or padded area to protect them from damage.

**\*\*\* Do not tighten screws & bolts until the entire unit is completely assembled.**

**1**

Attach Upper Side Panel (B) to Wood Top (A) by Bolt (D) and Allen Wrench (F) as shown.

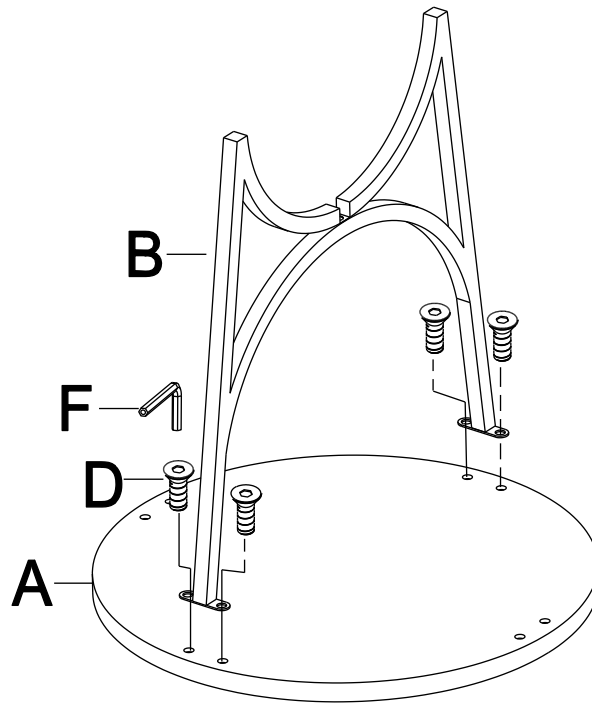

**2**

Attach Under Side Panel (C) to Wood Top (A) by Bolt (D) and Allen Wrench (F). Then attach two side panels together by Bolt (E) and Allen Wrench (F) as shown.

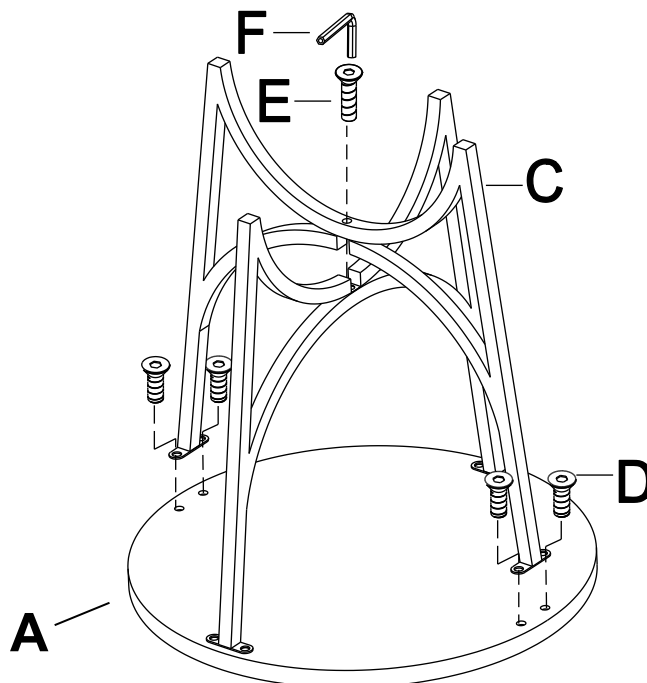

### Cleaning & Care

Treat surface with care. Surface is resistant to scratches but is not scratch resistant. Clean surfaces with a dry or damp soft cloth. Do not use abrasive cleaners. Hardware may loosen over time. Periodically check that all connections are tight.