















Introduction

Thanks for choosing Bistro Set. Our success depends on happy customers and we hope you will be pleased with your purchase. If there are missing part or broken parts, or if you need futher assistance, please contact customer service online.

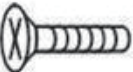
◆Notice:

1. 50% Tighten before fixing all screws.
2. Place the item on a flat ground to adjust and make sure it remains stable
3. Tighten up all screws with tools gradually
4. If the screws are not aligned with holes during assembly, please loosen all the other screws to 50% and continue the assembly process.
5. If the item is not stable, please loosen all the screws, adjust it on a flat ground and tighten up all screws again

◆PART LIST:

			
A: Table Top 1PC	B: Table Leg 3PCS	C: Leg Support 1PC	D: Backrest 2PCS
			
E: Chair Seat 2PCS	F: Chair Leg 8PCS	G (M8*25) 3+1PCS	H (M8*30) 26+1PCS
			
I: Washer 29+1PCS	J: Nuts 29+1PCS	K: Allen Wrench 1pc	L: Wrench 1pc
			
M: Spring Washer 26+1pcs			

◆Assembly:

The Chair:

STEP 1

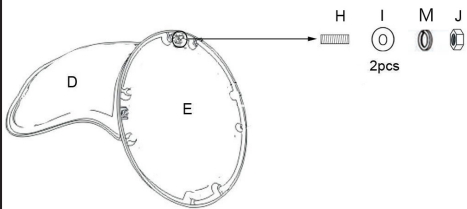

STEP 2

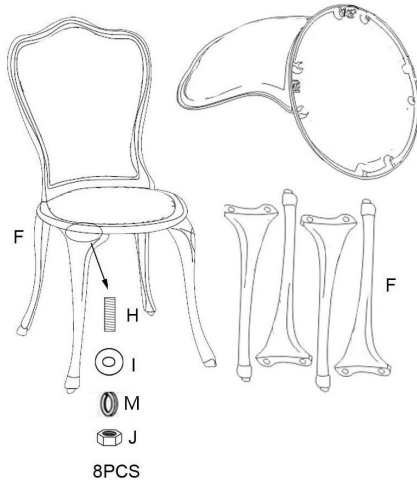

The Table:

STEP 3

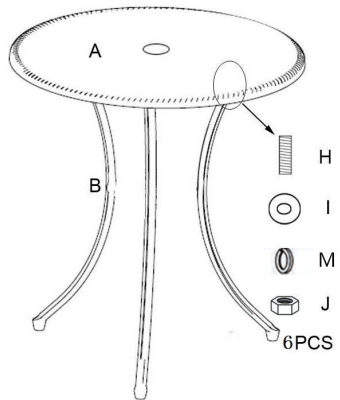

STEP 4

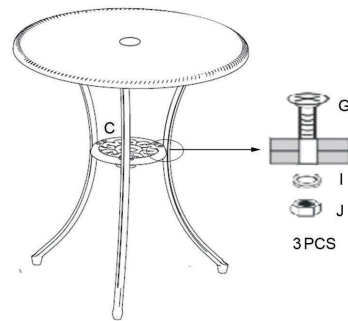

enjoy your life