

Care and Maintenance

Dust with a soft, dry cloth. Do not use abrasive cleaner. To clean mirror, spray a small amount of glass cleaner onto a lint-free cloth and wipe mirror clean.

Notice







* Please make sure that you have all parts indicated before you begin assembly of this item

* This item should be assembled on a soft surface to prevent scratching the finish during assembly

* This item may require periodic tightening

Product Dimensions: 51"W X19.5"D X19.75"H

Part List and Hardware List

Piece	Description	Picture	Quantity
A	Top Shelf		1X
B	Leg		1X
B-1	Leg		1X
C	Felt pad		4X
D	screws		8X(M6x10mm)
E	Top glass		1X

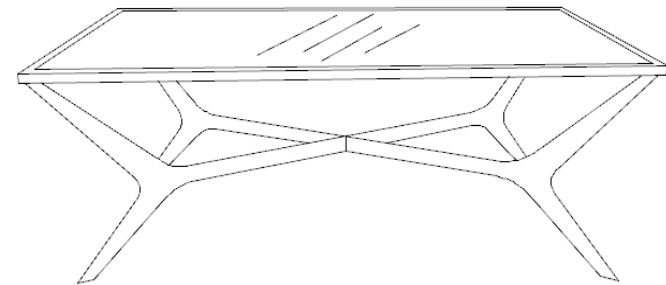

Preparation

Before beginning assembly of product, make sure all parts are present. Compare parts with package contents list and hardware contents list. If any part is missing or damaged, do not attempt to assemble the product.

Estimated Assembly Time: 10 minutes.

Tools Required for Assembly (included):Assembly Finial

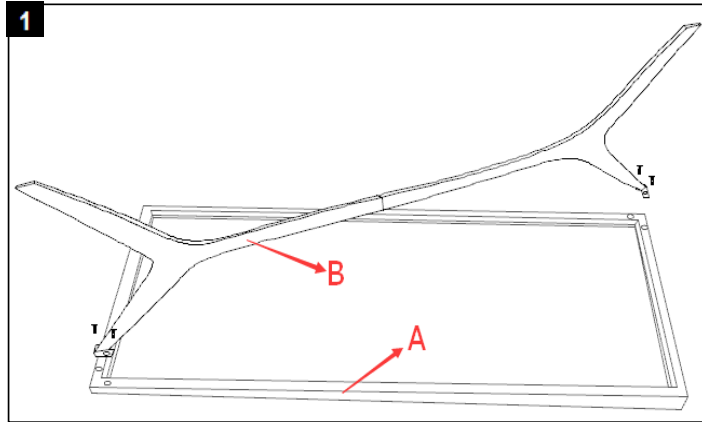

Step 1
Assemble the Leg(B) Top shelf(A) together using 4 screws(D).

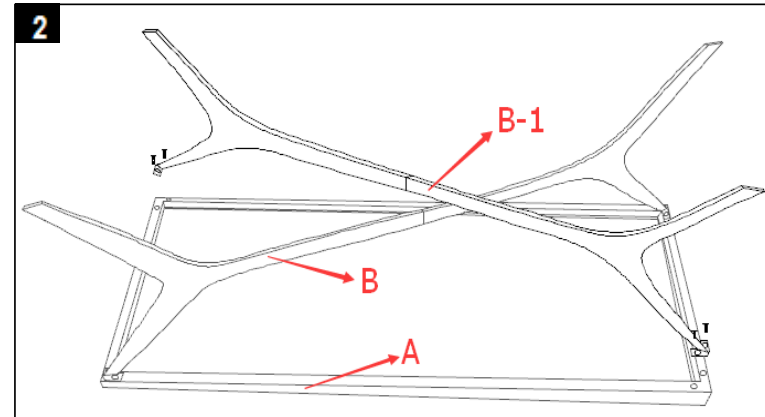

Step 2
Assemble the Leg(B-1) to Top shelf (A) using 4 screws(D).

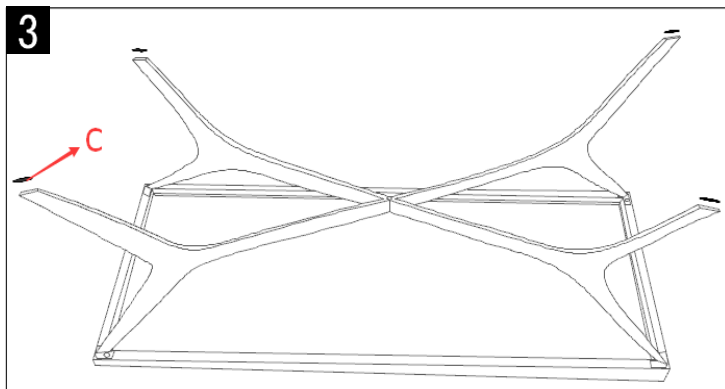

Step 3
Stick the Felt pad (C) on the bottom as show in picture.

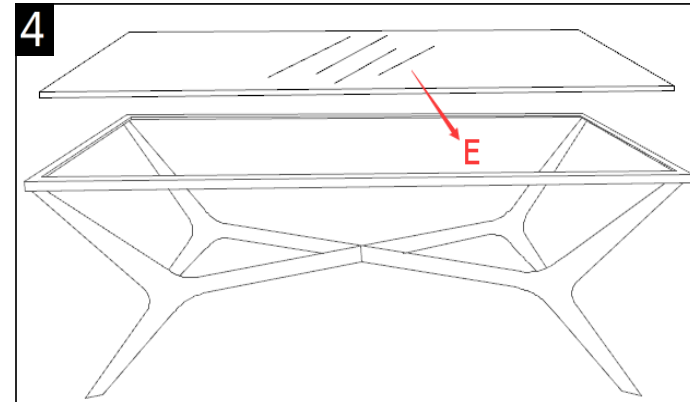

Step 4
Carefully place the Top glass(E) .