

Assembly Instructions

- Our clear, easy-to-follow, step-by-step instructions will guide you.
- Do not skip any steps. It is of utmost importance to assemble all of the parts according to the directions.
- Item identifications: For ease of identification, all parts are labelled to correspond to the step number in which the part is used.

Important

- Read the following instructions carefully before using the chair.
 - Be aware that some parts are heavy and have sharp edges.
 - Do not overtighten screws (insert all screws before tightening screws).
 - Firmly secure all bolts, screws and nuts before use.
 - Please do not exceed the weight limitations of this item.
- Reconfirm that all bolts, screws, and nuts are secure every 90 days.















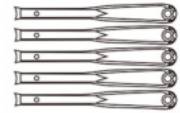

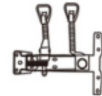
Care & Safety

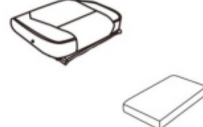
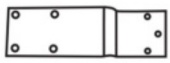
- Always use on firm level ground.
- Keep all children and pets away from the assembly area. Children and pets should be supervised while the product is being assembled.
- Vacuuming picks up dust and reduces the need for professional cleaning.
- In case of fire, do not attempt to extinguish any burning polypro-pyleneene with water.
- Be very careful when assembling chairs to avoid smashing your hands or fingers.
- Please contact Customer Services if you have any problems or discover any missing parts.

Maintenance

- Wash the surface with a soft cloth soaked in mild detergent and warm water. Pay attention to drying the water in time. Do not use solvents or abrasive kitchen cleaners.
 - Vacuum fabric as needed using an upholstery attachment.
 - Do not use or store this item in the proximity of proximity of open flame or flammable/-combutable chemicals.
 - Do not brush fabric or use a vacuum attachment with a rotary brush.
- Brushing may permanently damage the nap or change the character of the fabric.

Accessories List

<p>(1) Central Base Buckle</p>   <p>Central Base Buckle (1) is placed on top of Central Base Tube (2).</p>	<p>(2) Central Base Tube</p>   <p>Central Base Buckle (1) is placed on top of Central Base Tube (2).</p>	<p>(3) Split Base Tube</p> 	<p>(4) 5 Castors</p> 	
<p>(5) Air Rod</p> 	<p>(6) Base Plate</p> 	<p>(7) 2 Armrests</p> 	<p>(8) Backrest</p> 	
<p>(9) Seat Cushion</p> 	<p>(10) Steel plate</p> 	<p>(11) 4 Decoration Caps</p> 	<p>(12) Hexagon Wrench</p> 	
<p>(13) 5 Screws (M6x25)</p>  <p>M6 × 25</p>	<p>(14) 4 Screws (M8x35)</p>  <p>M8 × 35</p>	<p>(15) 3 Screws (M8x20)</p>  <p>M8 × 20</p>	<p>(16) 4 Screws (M6x25)</p>  <p>M6 × 25</p>	<p>(17) 4 Screws (M6x25)</p>  <p>M6 × 25</p>
				<p>(18) 4 Screws (M6x20)</p>  <p>M6 × 20</p>

Instructions for Use



Upward adjustment



Downward adjustment



Backrest adjustment



300LB(136kg)

Thanks for purchasing our products. Please read this manual before assembly. And please assemble in order. After the assembly, keep the instruction properly. Make sure all the parts are included (17 kinds in total).

Assembly Instruction

Step 1

Take out Split Base Tube (3). Central Base Tube (2) and Central Base Buckle (1). Insert Split Base Tube (3) into Central Base Tube (2) as shown. You can see there are screw holes. Align with the holes, tighten Screws M6X25mm (13) with Hexagon Wrench (12) to fix 5 Split Base Tube (3) to Central Base Tube (2). Repeat it five times. Finally, attach the Central Base buckle (1) to the Central Base Tube (2)

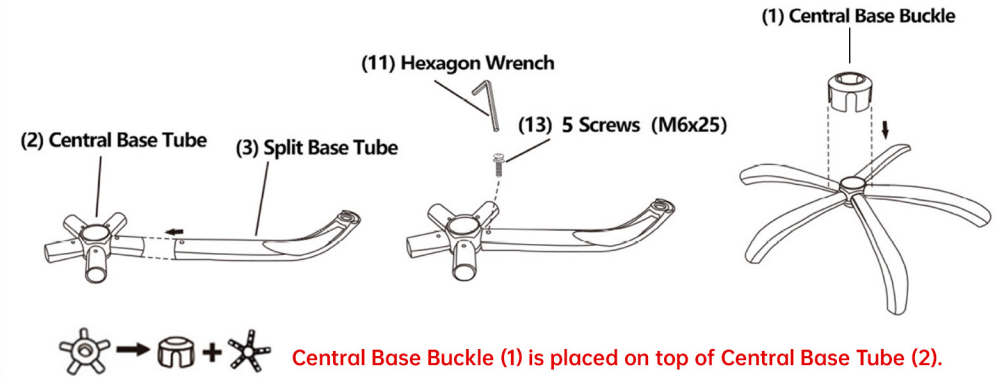

Step 2

Take out Castors (4). insert Castors (4) into part of Step 1 as shown. There are 5 Castors (4) need to be inserted.

*Caution: Confirm Castors (4) must be inserted deeply. Otherwise the castors could easily fall out and the chair could fall down. Take out Air Rod (5). Put Air Rod (5) into the hole of Central Base Tube (2) as shown. Put it aside and we'll use it in Step 5.

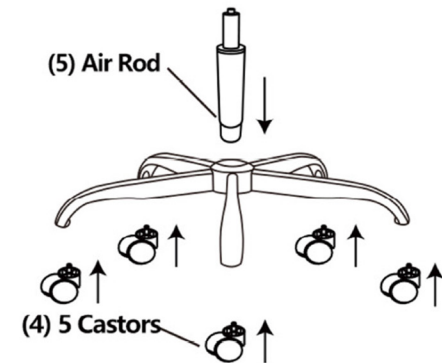

Step 3

Fix Base Plate (6) to the bottom of Seat Cushion (9). Tighten the Screws M6X25 (16) with Hexagon Wrench (12) firmly. Fix footrest Cushion to the footrest frame, Tighten the Screws M6x20 (18) with Hexagon Wrench (12) firmly.

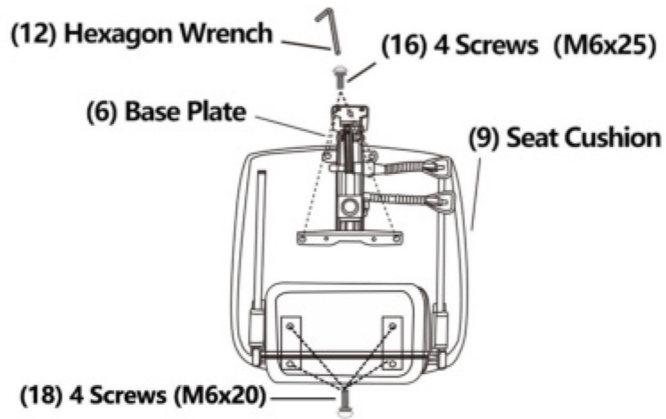

Step 5

Tighten the Screws M8X45 (14) with Hexagon Wrench (12) and fix the 2 armrests (7) between the backrest (8) and the seat cushion (9). Tighten the 4 screws firmly and then cover the screws with Decoration Caps (11). The assembly is complete now.

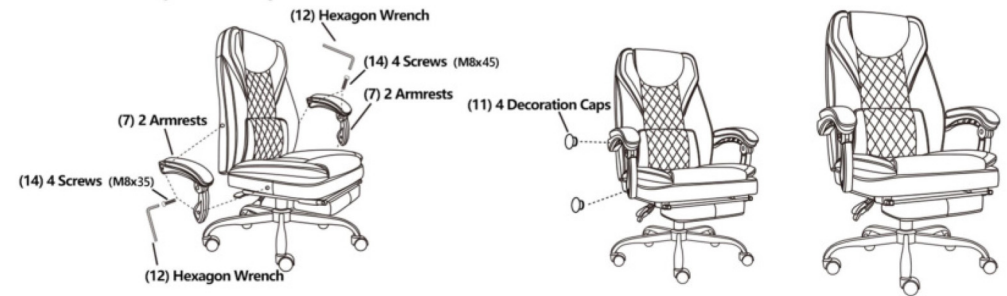

Step 4

First fasten the cushion (9) with steel plate (10) and tighten the M8X25 (15) screw with Hexagon Wrench (12). Then connect the backrest (8) and steel plate (10) and tighten the M6X25 (17) screws with Hexagon Wrench (12). Pick up the air rod (5) and the center base tube (2) from step 2. Insert the air rod (5) into the base plate (6). The base plate (6) has holes in the middle. Press the cushion (9) from top to bottom, with all the strength of your body.

