

Product Size :60" x 42" x 36"

Your furniture purchase is an investment. Here are a few tips to maximize the lifetime of your furniture with a minimum amount of effort. Properly caring for your furniture can help ensure that it looks great year after year.

Wood Furniture maintenance:

- Always dust, wipe, and dean with the grain of the wood.
- Dust with a soft cloth. Dust will scratch the furniture surface if not removed properly.
- Use the same type of polish consistently as interchanging oil-based and wax-based polishes will cause a build-up and result in a foggy or cloudy appearance.
- If a polished surface becomes foggy, rub it with a cloth dipped in a solution of one tablespoon vinegar to one quart of water. Rub softly with the grain until the surface is completely dry.
- Soap and water are not advisable for wood surfaces. Water can penetrate the finish and raise the grain on wood, causing damage.
- Remember to change dusting cloths frequently as dirty cloths may scratch your furniture's surface.

The Enemies of Wood:

- Moisture is wood's worst enemy. Liquid spills should be gently wiped up immediately. Coasters should be used under all beverages.
- Do not allow rubber or vinyl materials to lie on the furniture. Chemicals in rubber may leave a stain. Put a strip of felt or leather under accessories that have rubber or vinyl.
- Heat creates a chemical change in the furniture's finish, which results in a white spot. Use protective pads under hot dishes, appliances, etc.
- Sunlight's ultraviolet rays can damage the finish of furniture. Do not place furniture directly against a heater or radiator and do not place in the path of hot streams of air from central heating. This will cause extreme localized drying of the wood.

High Gloss Resin Table Maintenance:

- Resin tabletops have approximately 1/8" of resin coat on the top face of the table, which will resist ice, water, wine, liquor, food, leaning fluids, and warm or hot liquids; however, cups, glasses, etc. containing hot liquids should not be left on the table without a coaster for protection.
- Resin tabletops will scratch just the same as any other glossy surface and basic precautions should be taken.
- For lasting shine, the resin table should be waxed with a car wax that does not contain silicon. Maintaining this wax build-up will result in a high gloss shine.
- When wiping down the table, a soft, clean rag should be used. Do not use a heavy paper.

Granite Top maintenance:

The surface of the granite on your table has been polished or sealed to create a generally non-porous surface. The stone has many natural characteristics including: veining, hairline cracks, and color variations - which make up the stone's beauty.

To maintain the beauty of your granite:

- Protect surfaces from scratching, staining and etching by:
 - Keeping them free of debris or sharp objects
 - Wiping up spills immediately
 - Avoiding contact with chemicals (particularly acid-based materials)
- Clean with pH neutral products or those especially formulated for use on stone.
- It is not recommended to use a water-based solvent for dark granite as it will remove the polish from the surface.
- After a period of use, apply a penetrating sealer to prevent contaminants from being absorbed into the stone.
- Remove stains with special absorbent poultices formulated for use on stone.
- Renew the surface on polished granite (granite with a high gloss surface by buffing with special stone polish, powder or cream. Do not use granite polish on granite with a matte finish, which has been honed rather than polished. (Penetrating sealer may be used on both polished and honed granite.)

Marble Top maintenance:



Marble may be stone, but it is porous stone and can stain easily. Treating marble surfaces the same as wood surfaces is a great rule of thumb.

- It is recommended to seal the tops on a regular basis (every 6 to 12 months). A good quality stone sealer can be purchased from any tile/stone store or any homecare store and should be applied according to the manufacturer's recommendation.
- When sealed properly, marble tops can be used indoors and outdoors and can withstand any weather conditions except internal freezing. Snow or freezing rain will penetrate the table and cause cracks.

Caring for the Fabric on Upholstered Furniture:

- Frequent vacuuming of the entire upholstered area will prevent dust from settling into the fibers.
- Professional cleaning is always recommended for all upholstered pieces.
- Always pre-test a small area of fabric in an inconspicuous area when cleaning before proceeding.
- Do not use cleaning products containing brightening agents.

VERY IMPORTANT!!

<p>NEVER USE GLASS CLEANERS ON FINISHED SURFACES. AMMONIA WILL CHEMICALLY ATTACK THE FINISH.</p>	<p>DO NOT WRITE DIRECTLY ON SURFACE </p> <p style="text-align: center;">PREVENT MARKING</p>	<p>DO NOT PLACE DIRECTLY IN SUNLIGHT </p> <p style="text-align: center;">PREVENT FADING</p>	<p>DO NOT USE PLACEMATS WITH RUBBER BASES </p> <p style="text-align: center;">PREVENT DISCOLORING</p>
<p>NEVER ALLOW LIQUIDS OF ANY KIND TO LINGER ON SURFACES. ABSORPTION CAUSES THE WOOD TO WARP AND THE FINISH TO DE-LAMINATE.</p>	<p>DO NOT USE COMMERCIAL POLISHES AND WAXES </p> <p style="text-align: center;">PREVENT YELLOWING</p>	<p>DO NOT PLACE HOT POTS, ETC. ON SURFACE </p> <p style="text-align: center;">PREVENT DAMAGE TO FINISH!</p>	<p>REGULATE THE HUMIDITY CONDITIONS AT YOUR HOME </p> <p style="text-align: center;">PREVENT SPLITTING</p>

ASSEMBLY INSTRUCTIONS

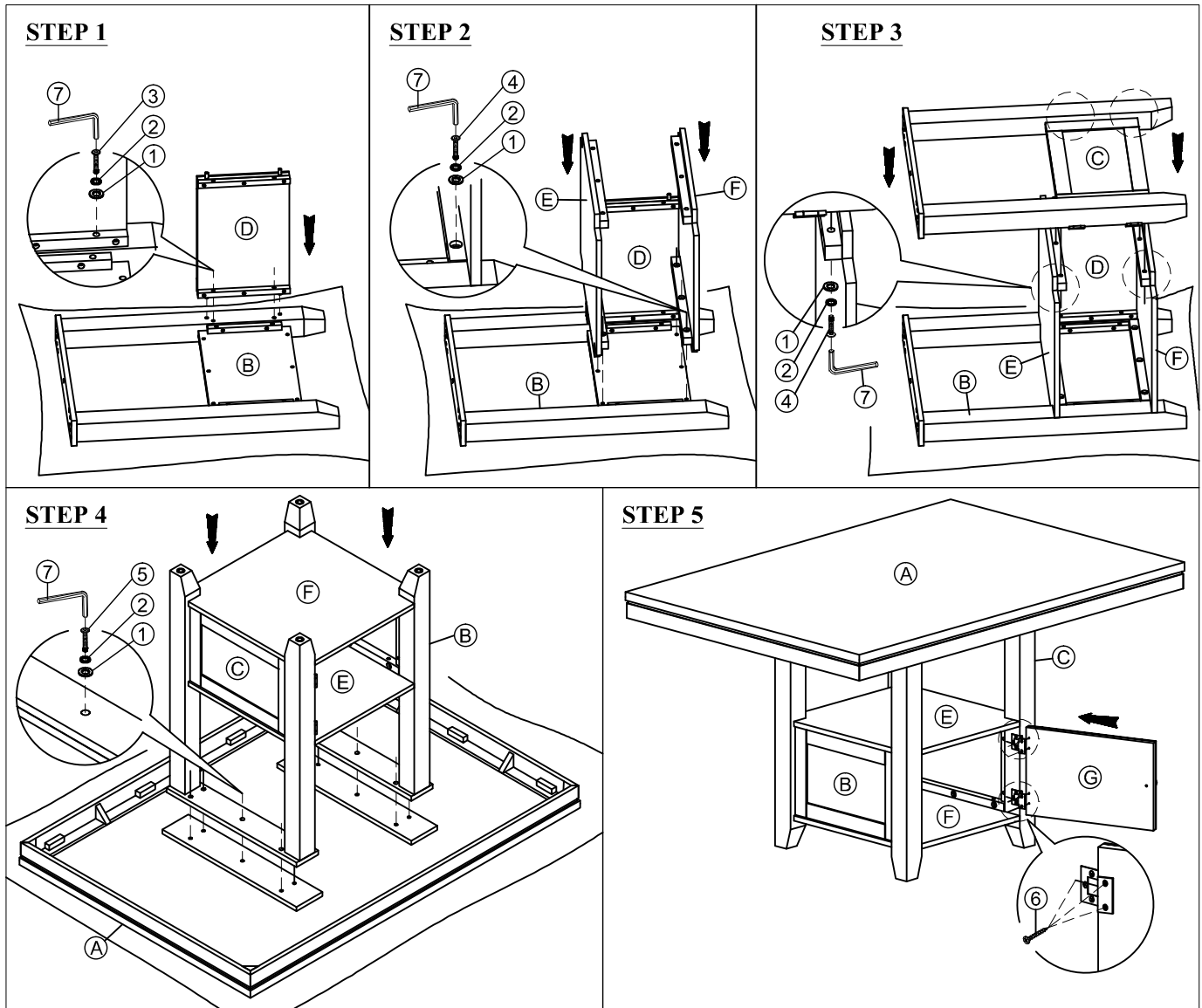

Step 1

Turn the LSF Leg Frame (B) upside down on the floor with a piece of cloth or carpet underneath to prevent finish from scratching. Attach Back Panel (D) to the LSF Leg Frame (B) by using Flat Washer (1), Spring Washer (2), and Small Long Bolt (3). Tighten with Allen Key (7).

Step 2

Attach Top Panel (E) and Bottom Panel (F) to the LSF Leg Frame (B) by using Flat Washer (1), Spring Washer (2), and Short Bolt (4). Tighten with Allen Key (7).

Step 3

Attach the RSF Leg Frame (C) to the Back Panel (D), Top Panel (E) and Bottom Panel (F) by using Flat Washer (1), Spring Washer (2), and Short Bolt (4). Tighten with Allen Key (7).

Step 4

Turn the Table Top (A) upside down on the floor with a piece of cloth or carpet underneath to prevent finish from scratching. Attach Table Base assembly in Step 3 to the Table Top (A) by using Flat Washer (1), Spring Washer (2), and Big Long Bolt (5). Tighten with Allen Key (7). Turn table upright position.





Step 5

Attach the Door (G) to the Hinge on RSF Leg Frame (C) secure the screw (6) through the hinge and pre-drill hole on the Door (G). Tighten all screw with a philip-head screwdriver (Not provided).

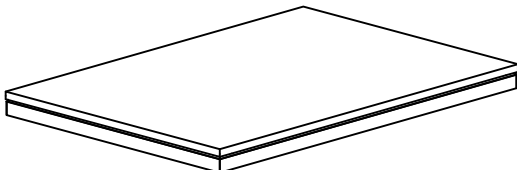
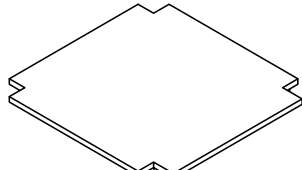
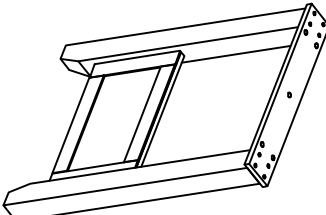
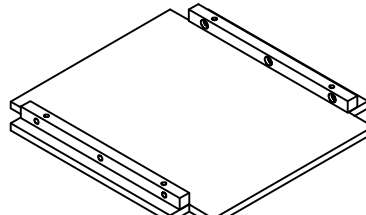
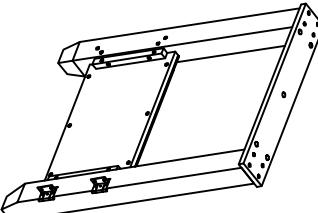
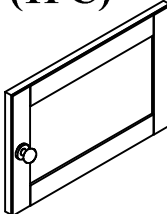
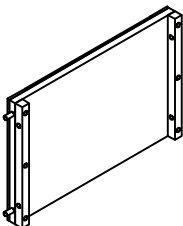
Product assembly is now completed.

PARTS LIST

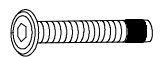
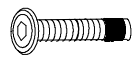
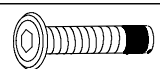
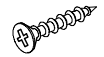
<p>(A) TABLE TOP (1PC)</p> 	<p>(E) TOP PANEL (1PC)</p> 
<p>(B) LSF LEG FRAME (1PC)</p> 	<p>(F) BOTTOM PANEL (1PC)</p> 
<p>(C) RSF LEG FRAME (1PC)</p> 	<p>(G) DOOR (1PC)</p> 
<p>(D) BACK PANEL (1PC)</p> 	

NO.	DESCRIPTION		SIZE	Q'TY
1		Flat Washer	Ø5/16" x 16mm	26pcs
2		Spring Washer	Ø5/16" x 13mm	26pcs
3		Small Long Bolt	Ø1/4" x 40mm	4pcs
4		Short Bolt	Ø1/4" x 30mm	12pcs
5		Big Long Bolt	Ø5/16" x 40mm	10pcs
6		Screw	M3.5x15mm	6pcs
7		Allen Key	M4 x 60mm	1pc
8		Straight Allen Key	M4 x 75mm	1pc

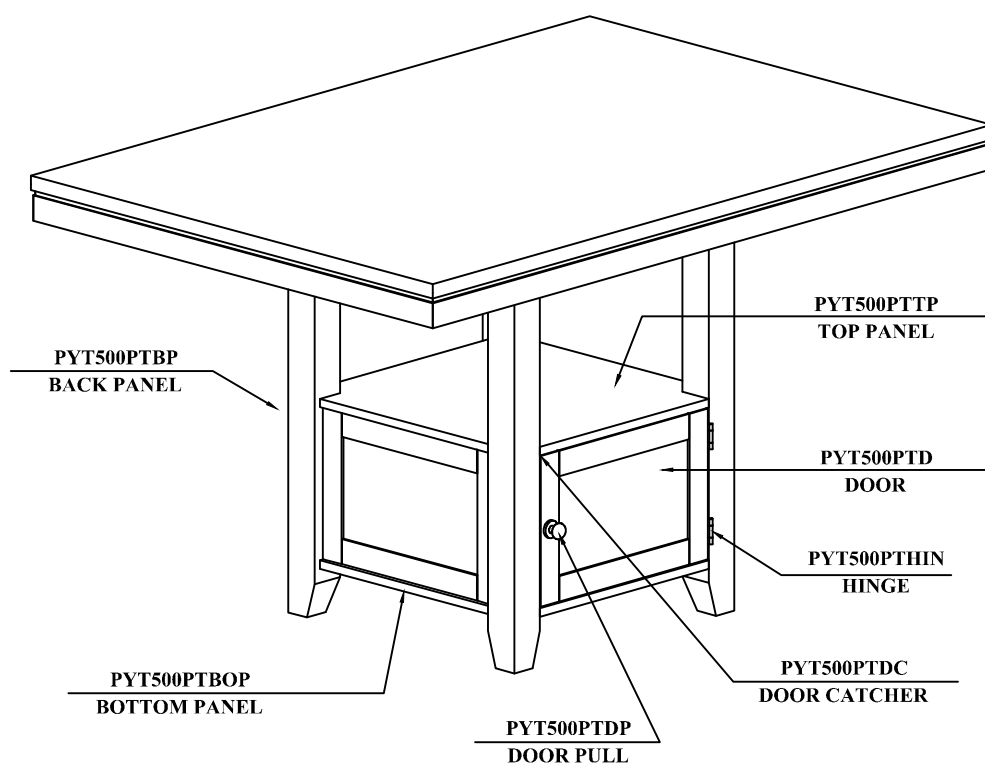

PRODUCT DETAILS

Table Top	MDF + Mindy Veneer + Mindywood
Leg Frame	MDF + Mindy Veneer + Mindywood
Back Panel / Door	MDF + Mindy Veneer + Mindywood
Top/Bottom Panel	MDF + Mindy Veneer
Product Size	60" x 42" x 36"
Carton Size	L64" x W45.5" x 8"H
Net Weight	132LBS
Gross Weight	149.6LBS
Cuft	13.48/ 1Pc