

CARE AND MAINTENANCE

Store outdoor furniture indoors or cover well when not in use.

Remove wooden furniture from standing water. Dust regularly with small brush or vacuum

Spills should be taken care of immediately before they harden or stain with a slightly dampened sponge.

NOTICE

* Please make sure that you have all parts indicated before you begin assembly of this item



















* This item should be assembled on a soft surface to prevent scratching the finish during assembly

* This item may require periodic tightening

**Weight Capacity : 275 lbs (single seat)
550 lbs (two person seat)**

**Warning : Do not stand on bench
Warning : Do not over torque bolts/screws**

Part List

PIECE	DESCRIPTION	PICTURE	QUANTITY
1	RIGHT FRAME		1 X
2	BACK FRAME		2 X
3	RIGHT SEAT BENCH		1 X
4	LEFT FRAME		1 X
5	LEFT SEAT BENCH		1 X
6	LEFT CORNER FRAME		1 X
7	RIGHT CORNER FRAME		1 X
8	SEAT CORNER		2 X
9	TOP TABLE/STOOL		2 X
10	LEG		16 X
11	BACK BENCH CUSHION		5 X
12	BACK CORNER CUSHION		1 X
13	SEAT CUSHION		2 X
14	SEAT CORNER CUSHION		1 X
15	STOOL CUSHION		1 X
16	OVAL PILLOW CUSHION		2 X
17	PILLOW CUSHION		2 X
18	GLASS		1 X

Product Dimension:









26.77"x26.77"x13.38" (TABLE)

28.74"x28.74"x25.59" (CORNER)

54.72"x28.74"x25.59" (RIGHT BENCH)

54.72"x28.74"x25.59" (LEFT BENCH)

Hardware List

PIECE	DESCRIPTION	PICTURE	QUANTITY
A	BOLT M6 x 60 MM		1 X
B	BOLT M6 x 40 MM		17 X
C	SCREW M6 x 25 MM		32 X
D	FLAT WASHER		51 X
E	ALLEN KEY		3 X
F	NUT		1 X
G	KEY		1 X
H	CONNECTOR		2 X

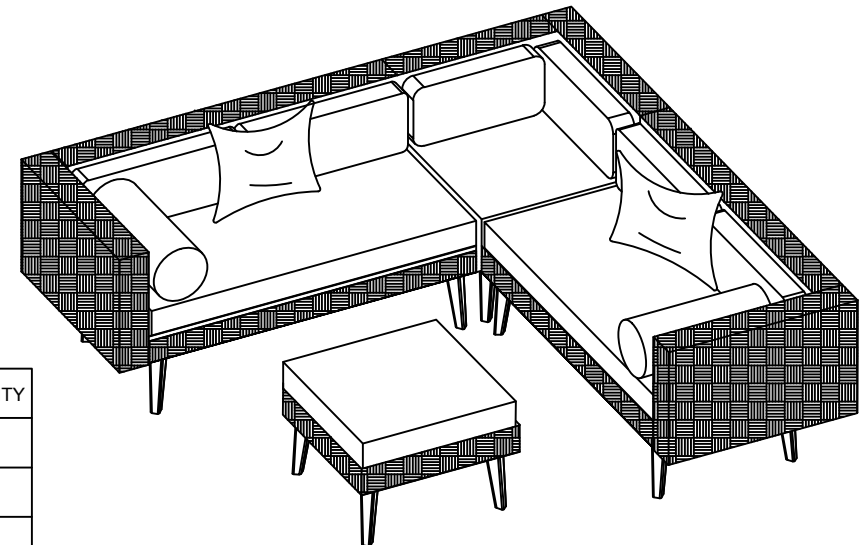

CARE AND MAINTENANCE

Store outdoor furniture indoors or cover well when not in use.
 Remove wooden furniture from standing water. Dust regularly with small brush or vacuum
 Spills should be taken care of immediately before they harden or stain with a slightly dampened sponge.

NOTICE

- * Please make sure that you have all parts indicated before you begin assembly of this item
- * This item should be assembled on a soft surface to prevent scratching the finish during assembly
- * This item may require periodic tightening













Weight Capacity : 275 lbs (single seat)
550 lbs (two person seat)
Warning : Do not stand on bench
Warning : Do not over torque bolts/screws

Product Dimension:

26.77"x26.77"x13.38" (TABLE)
 28.74"x28.74"x25.59" (CONNER)
 54.72"x28.74"x25.59" (RIGHT BENCH)
 54.72"x28.74"x25.59" (LEFT BENCH)



Part List and Hardware List

PIECE	DESCRIPTION	PICTURE	QUANTITY
1	RIGHT FRAME		1 X
2	BACK FRAME		1 X
3	RIGHT SEAT BENCH		1 X
10	LEG		4 X
11	BACK BENCH CUSHION		2 X
13	SEAT CUSHION		1 X
16	OVAL PILLOW CUSHION		1 X
17	PILOW CUSHION		1 X
B	BOLT M6 x 40 MM		6 X
C	SCREW M6 x 25 MM		8 X
D	FLAT WASHER		14 X
E	ALLEN KEY		1 X

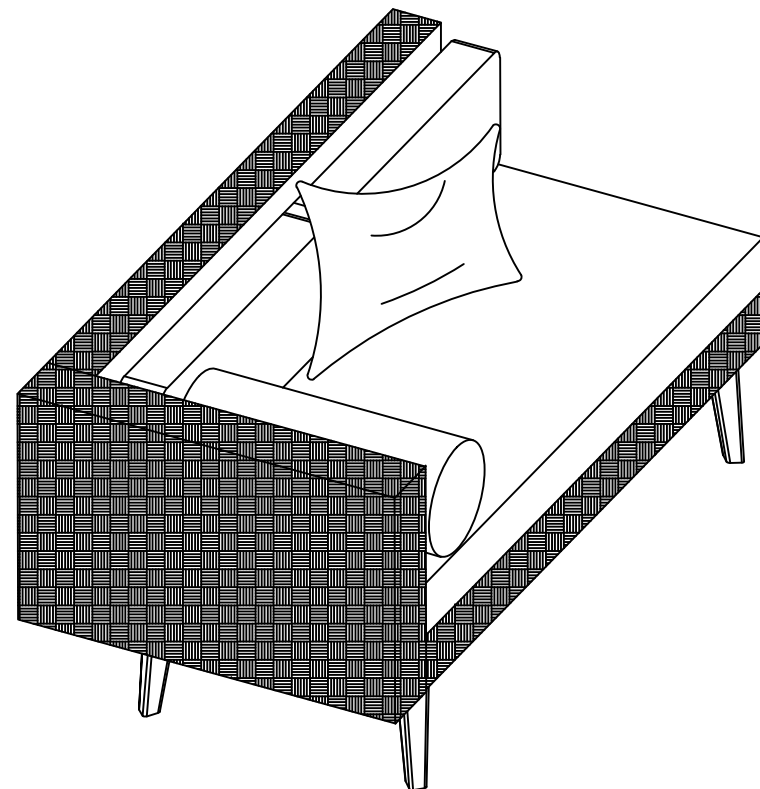

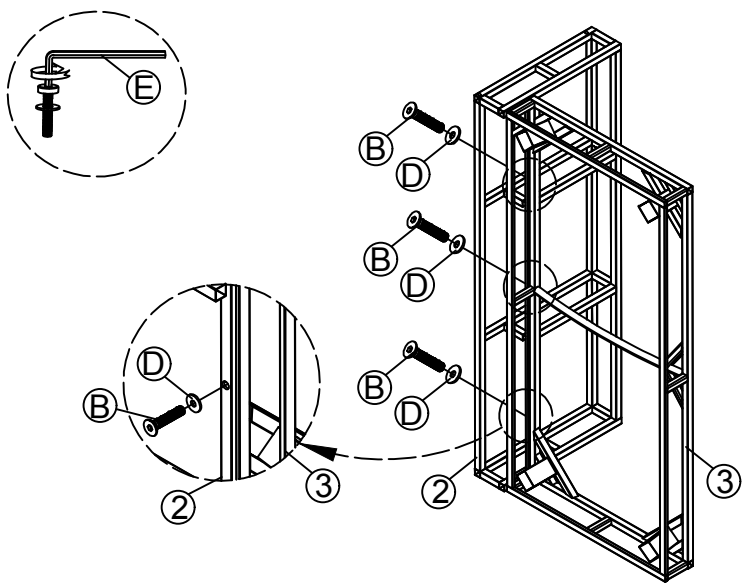

STEP 1: Connect Right Seat Bench (3) & Back Frame (2), tighten Allen Bolt (B), Flat Washer (D) with Allen Key (E).

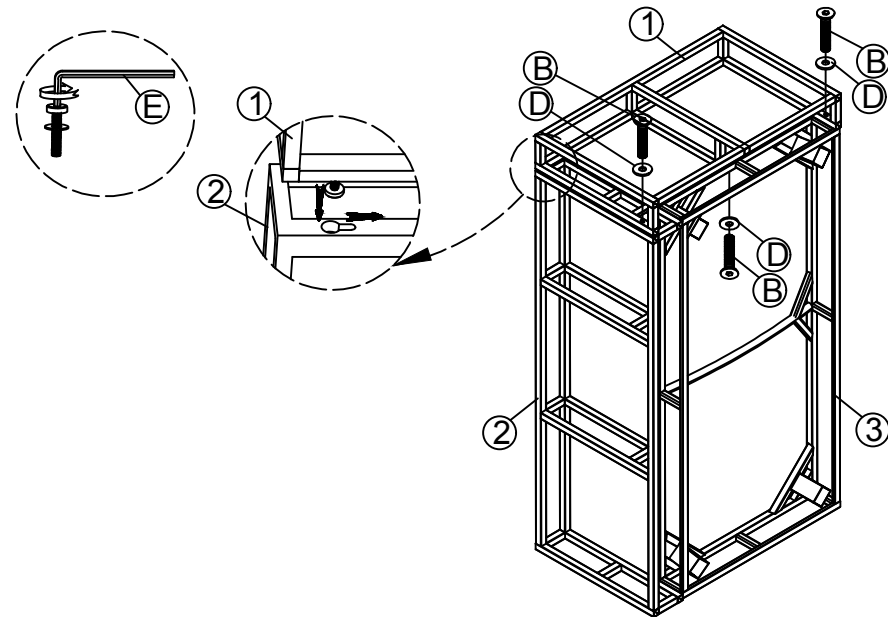

STEP 2: Connect Right Frame (1) & The Part from Step (1), tighten Allen Bolt (B), Flat Washer (D) with Allen Key (E).

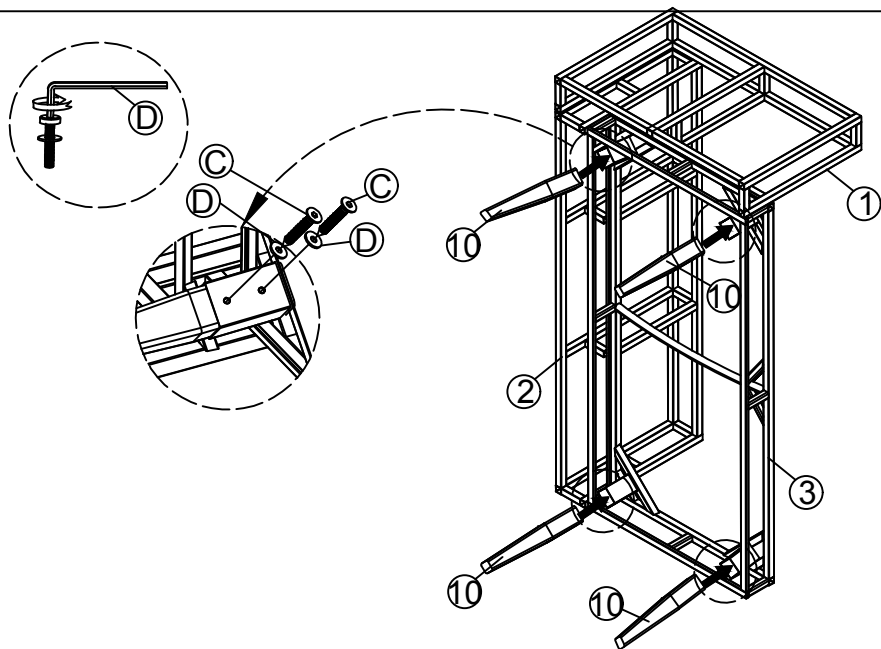

STEP 3: Connect Leg (10) & The Part from Step (3), tighten Screw (C), Flat Washer (D) with Allen Key (E).

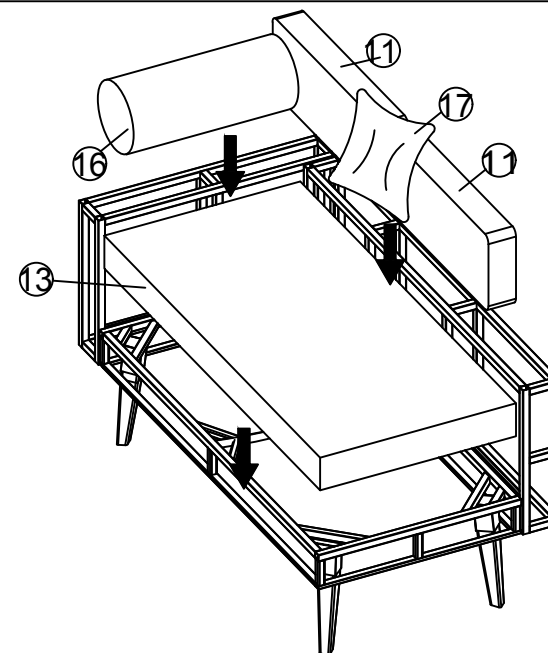

STEP 4: Put Back Bench Cushion (11), Oval Pillow Cushion (16), Pillow Cushion (17) and Seat Cushion (13) to finish Right Bench.