

# Adirondack Rocking Chair

## Assembly Guide

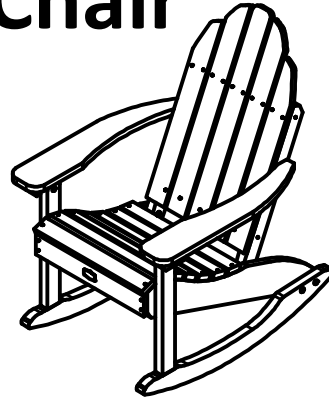
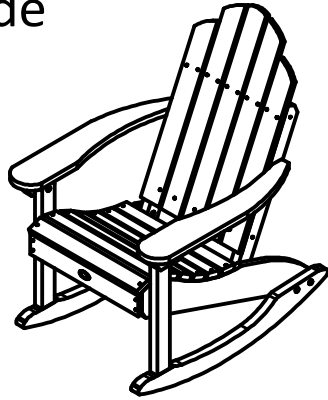

\*Actual Style May Vary from  
the One Pictured in this Guide

### HARDWARE INCLUDED

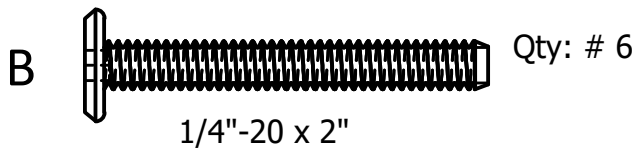
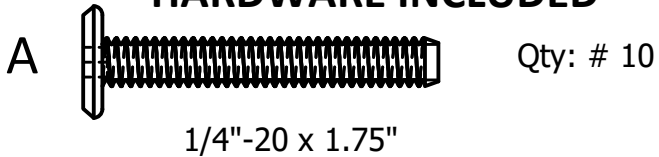

### TOOLS INCLUDED

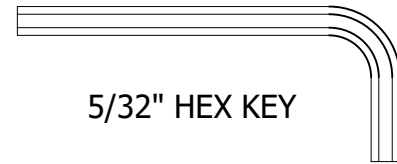

### IMPORTANT!

DO NOT fully tighten bolts until all bolts are started.

**1)** With the Back and Seat on their sides, attach one side of the Back to the Seat using two A bolts.

**2)** Repeat on other side.

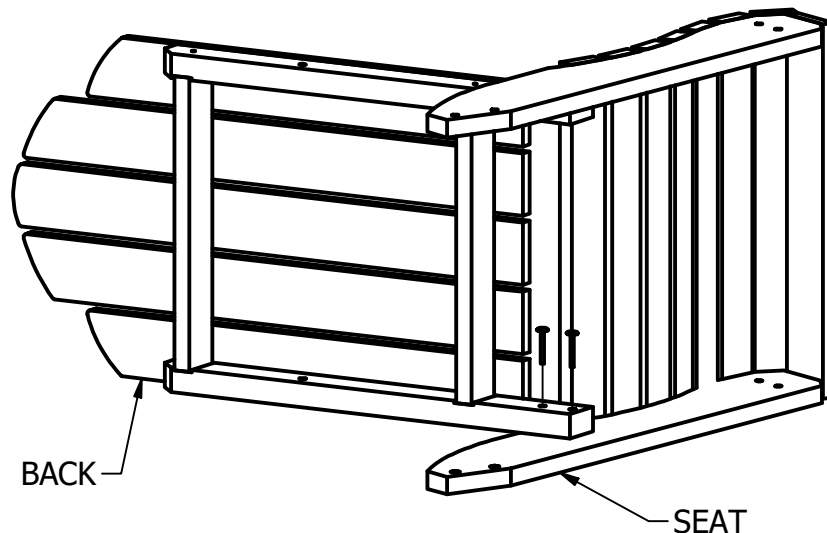

**3)** Attach front of Leg Assembly to Seat using two A bolts. Attach back of Leg Assembly to Seat using two B bolts.

**4)** Repeat on other side.

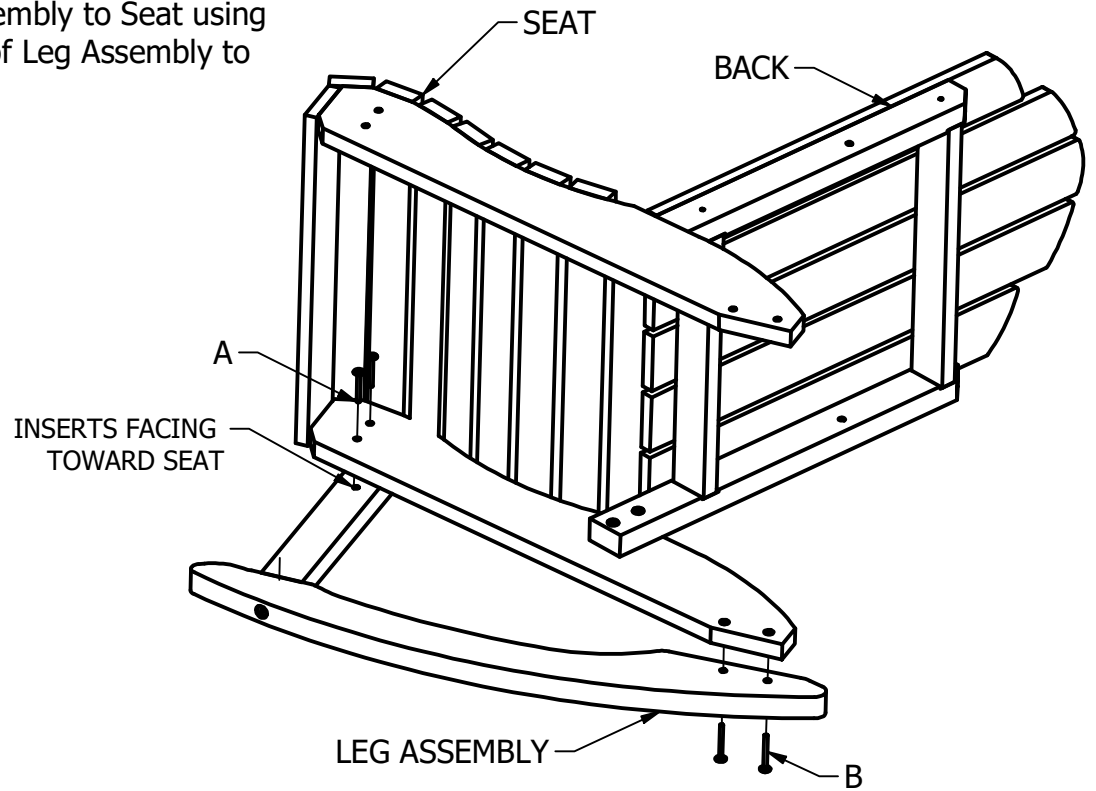

**5)** Attach Arm Assembly to Leg using one B bolt. Attach Arm Assembly to Back using one A bolt.

**6)** Repeat on other side.

