

As this item contains many parts, please read the installation instruction carefully before installation. Please use tools properly and carefully. If you have any questions about the product and installation, please contact us.

Before You Start

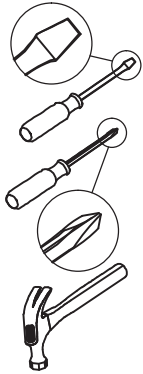

- ✓ Read through each step carefully and follow the proper order
- ✓ Separate and count all parts and hardware
- ✓ Give yourself enough room for the assembly process
- ✓ Have the following tools: Flat Head Screwdriver, #2 Phillips Head Screwdriver and Hammer
- ✓ Caution: If using a power drill or power screwdriver for screwing, please be aware of to slow down and stop when screw is tight. (Assembly speed can be increased by using electric screwdriver)

Helpful Hints

PEOPLE NEEDED FOR ASSEMBLY: 1-2

- Open your item in the area you plan to keep it to avoid excessive heavy lifting.



- Identify, sort and count the parts before attempting assembly.

- Compression dowels are lightly tapped in with a hammer.

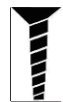

- Slides are labeled with an **R** (right) and **L** (left) for proper placement.

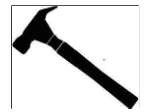

- Make sure to always face the point on the top of the Cam Lock towards the outer edge.



- If there is a back panel in the package, please install it to make sure your unit is complete and sturdy.



- Please fix all the screws provided for the back panel which can enhance product stability. If it is difficult to fix it when tightening, it can be fixed with the help of a hammer and then tightened.



- Do NOT use harsh chemicals or abrasive cleaners on this item.

- Never push, pull, or drag your furniture.

Board Identification

Not actual size

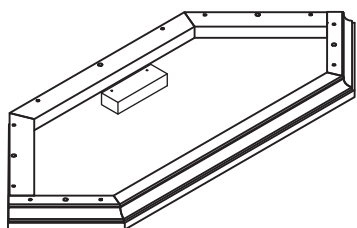

Ⓐ
TOP
Qty:1

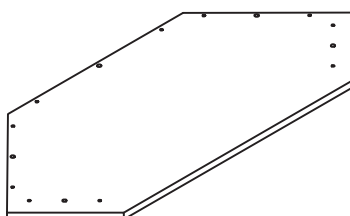

Ⓑ
INTERMEDIATE PLATE
Qty:1

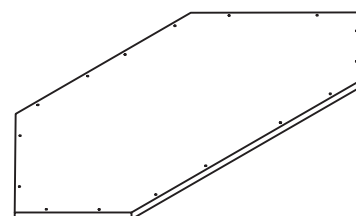

Ⓒ
BOTTOM PLATE
Qty:1

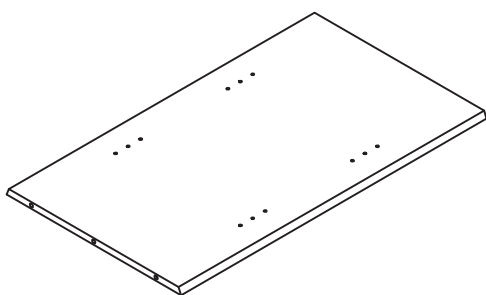

Ⓓ
POSTNOTUM
Qty:2

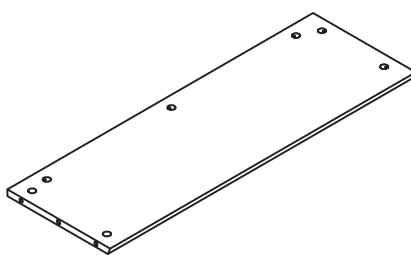

Ⓔ
LEFT POSTERIOR LATERAL PLATE
Qty:2

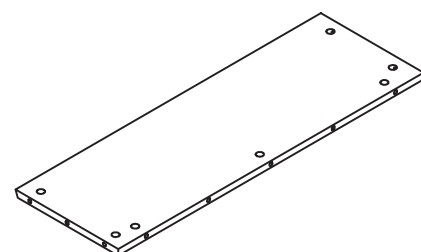

Ⓕ
RIGHT POSTERIOR LATERAL PLATE
Qty:2

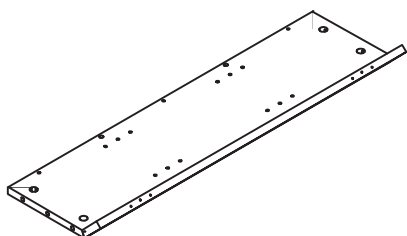

Ⓖ
LEFT SIDE PLATE
Qty:2

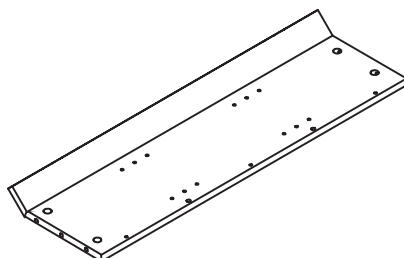

Ⓗ
RIGHT SIDE PLATE
Qty:2

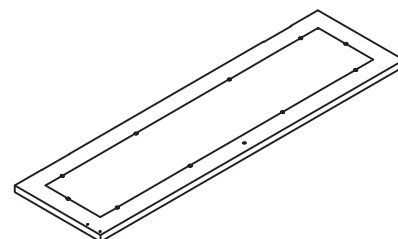

Ⓘ
LEFT DOOR PANEL
Qty:1

Board Identification

Not actual size

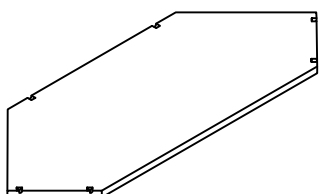

ⓐ

MOVABLE LAMINATE

Qty:4

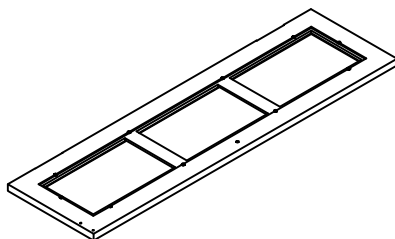

ⓑ

LEFT DOOR PANEL

Qty:1

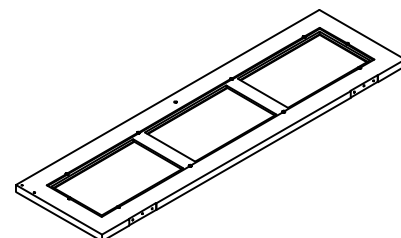

ⓒ

RIGHT DOOR PANEL

Qty:1

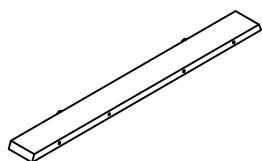

ⓓ

FRONT BRACE

Qty:1

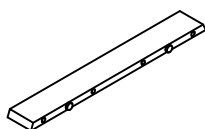

ⓔ

BACK BRACE

Qty:1

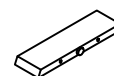

ⓕ

LEFT FRONT SIDE BRACE

Qty:1

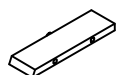

ⓖ

RIGHT REAR BRACE

Qty:1

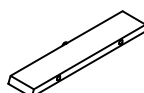

ⓗ

LEFT REAR BRACE

Qty:1

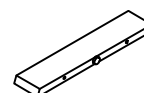

ⓘ

RIGHT FRONT SIDE BRACE

Qty:1

Board Identification

Not actual size

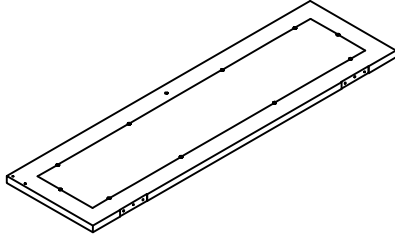

Ⓢ

RIGHT DOOR PANEL

Qty:1

Part List

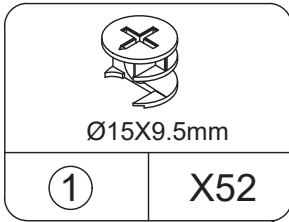

CAM LOCK
spare:3

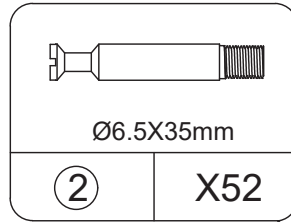

CAM BOLT
spare:3

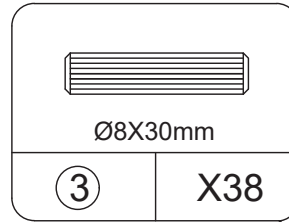

WOOD DOWEL
spare:3

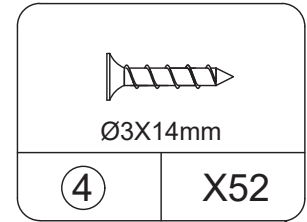

SCREW
spare:3

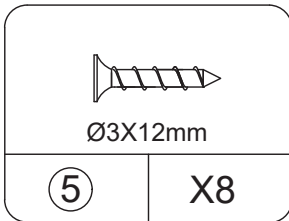

SCREW
spare:1

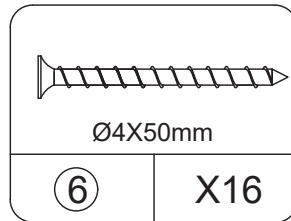

SCREW
spare:1

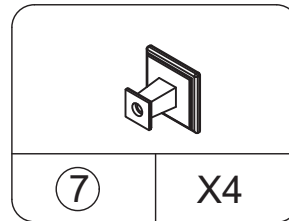

SCREW

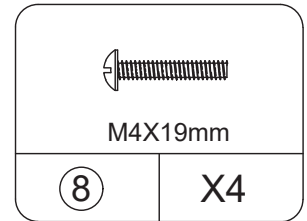

SCREW

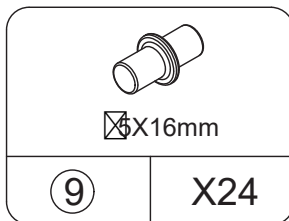

SHELF SUPPORT
spare:1

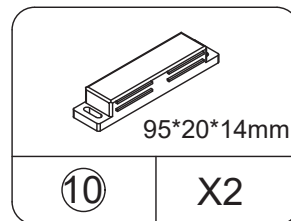

MAGNETIC BUMP

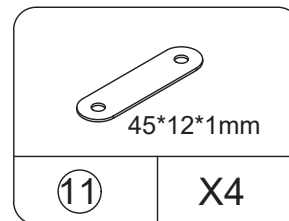

PLECES OF IRON

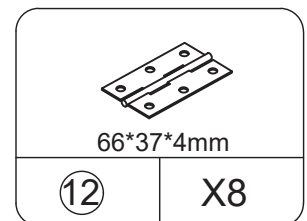

PERFECT STICKERS

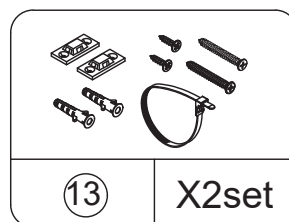

TIPPING RESTRAINT
HARDWARE KIT

Cam Lock Fastening System

Insert the cam bolt into the hole first, then insert the cam lock and lock it.

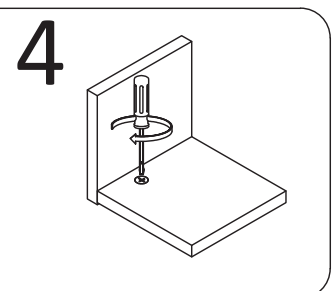
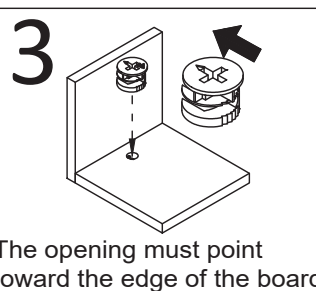
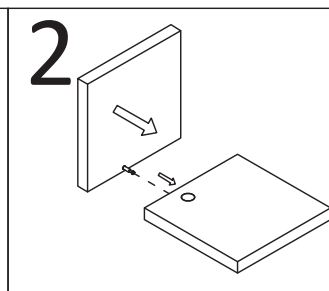
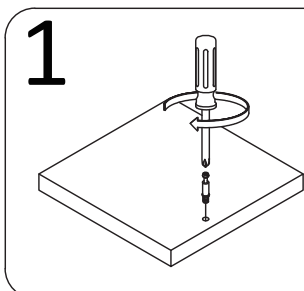

Board Identification

Not actual size

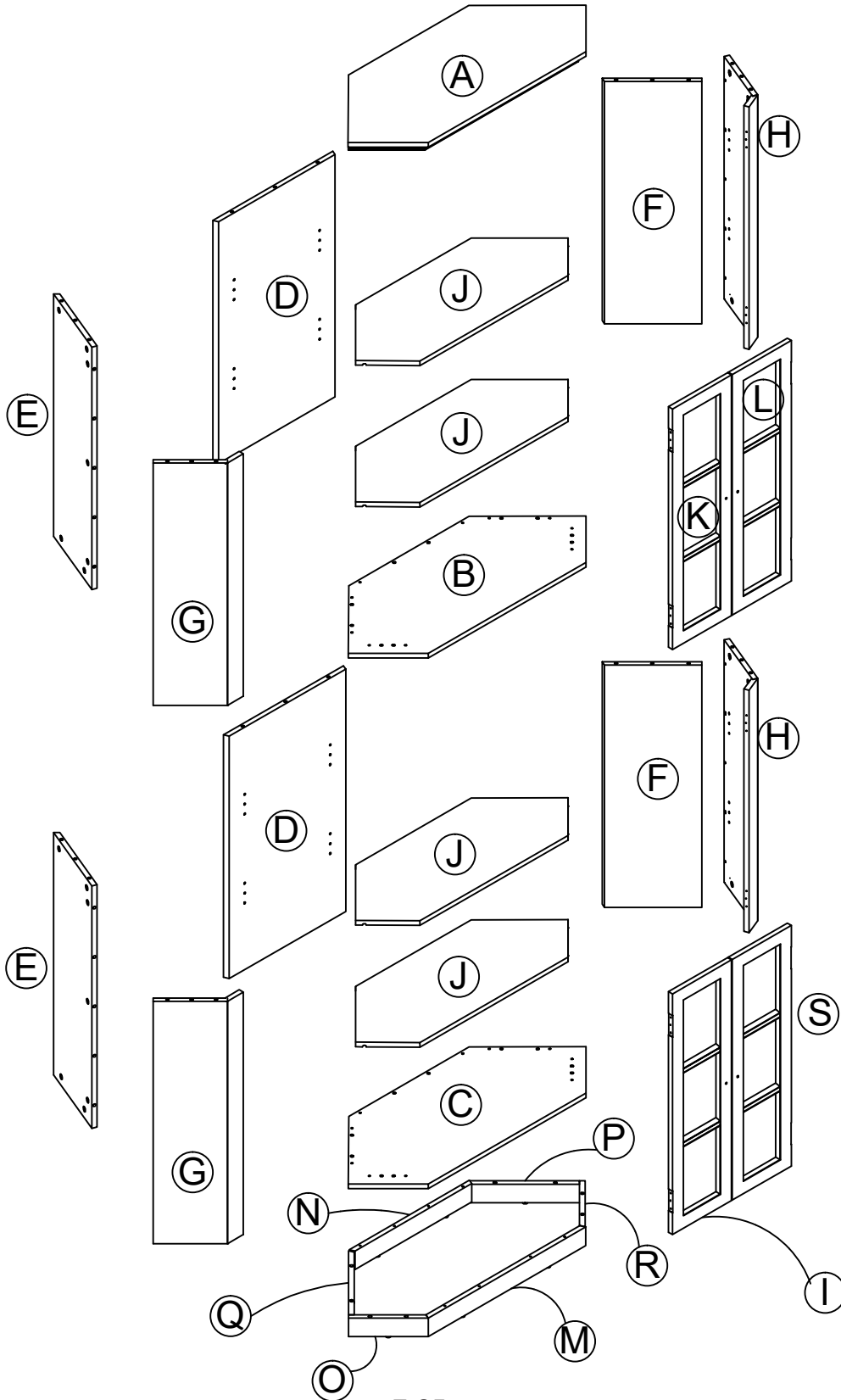

STEP 1

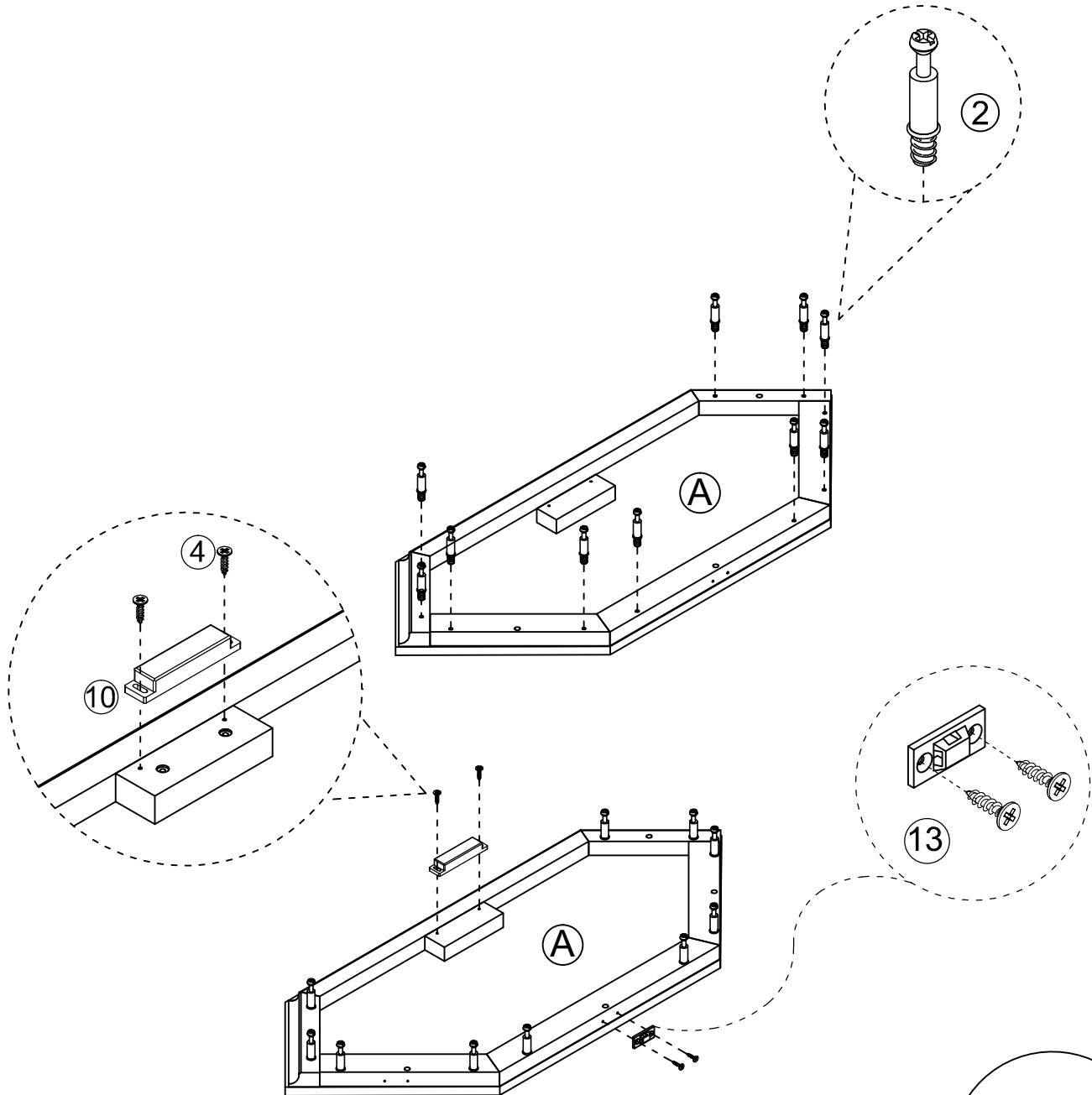
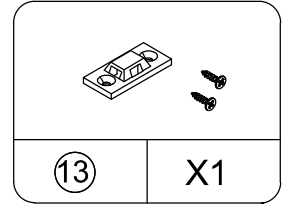
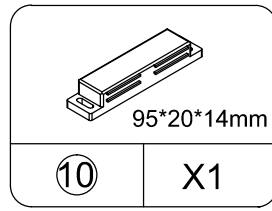
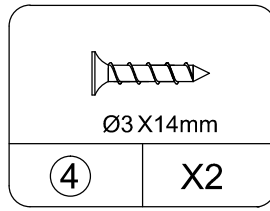
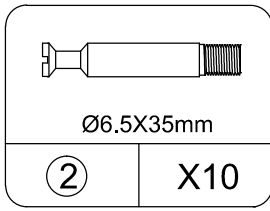
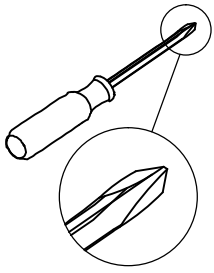

Select a installation method based on the installation location. For details, see Step 15

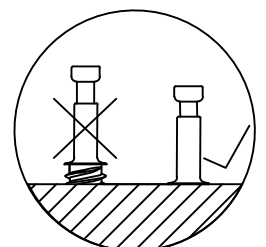

STEP 2

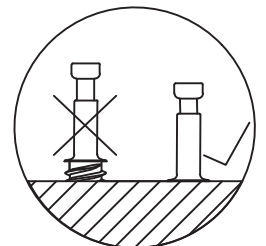
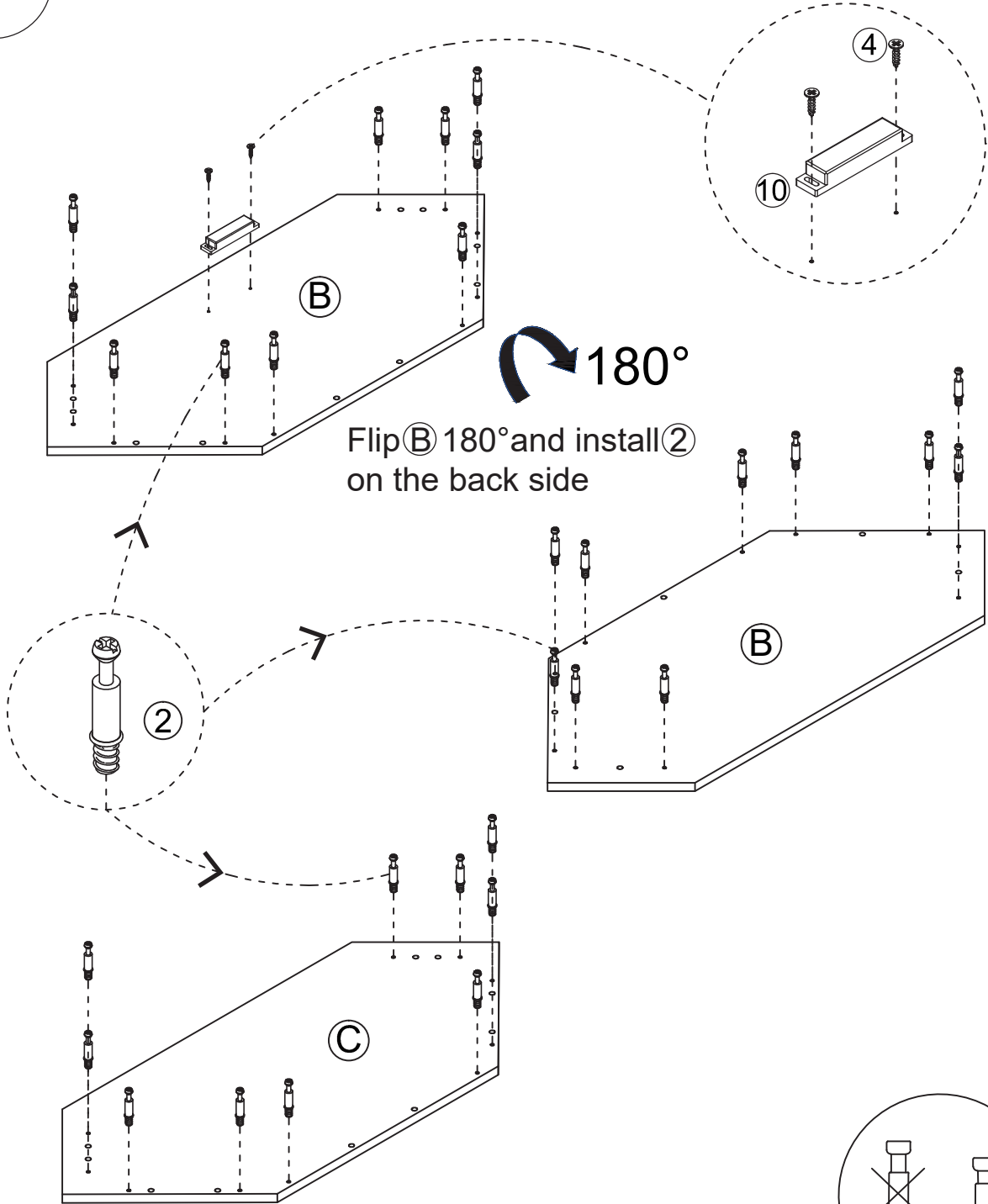
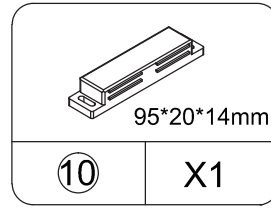
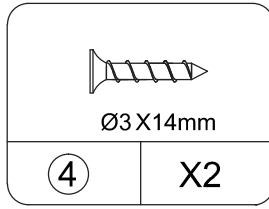
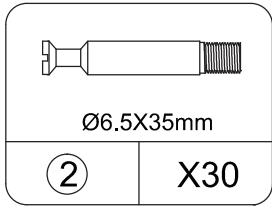
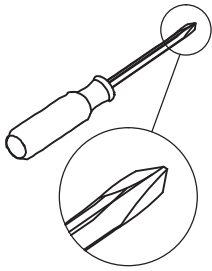

STEP 3

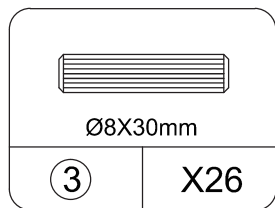
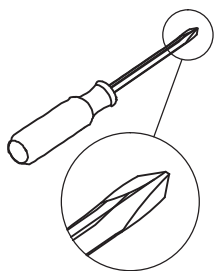

X2

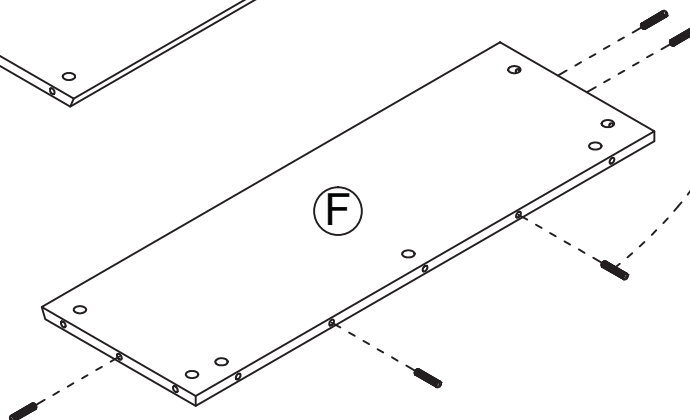
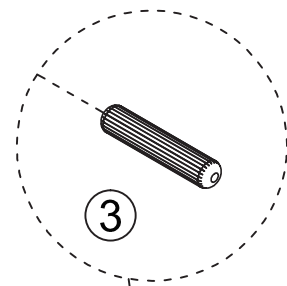
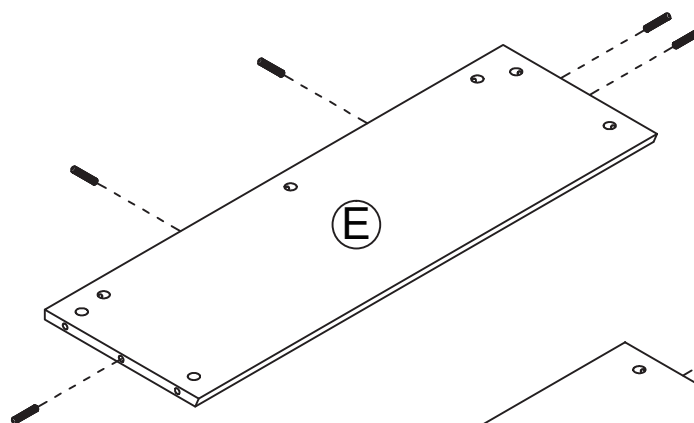
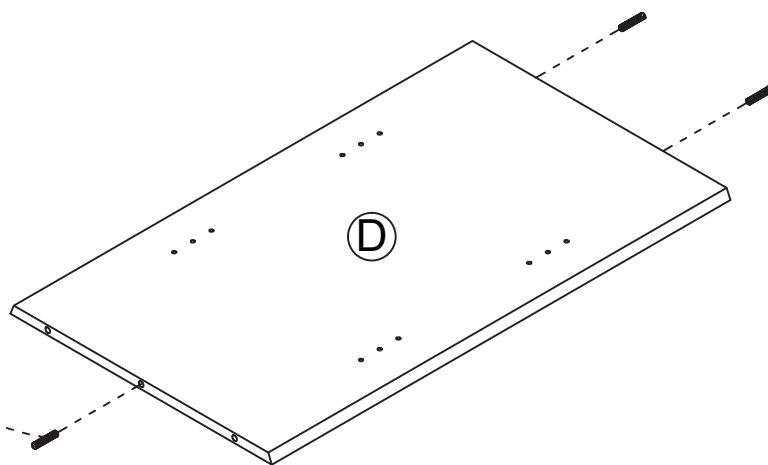
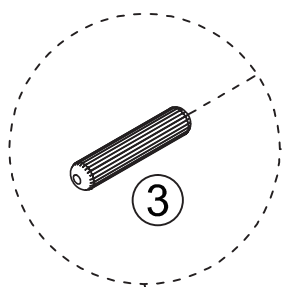

STEP 4

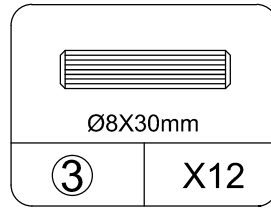
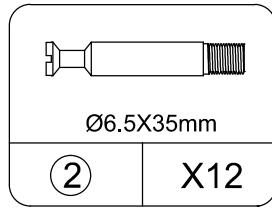
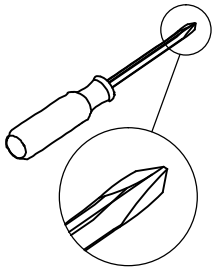

X2

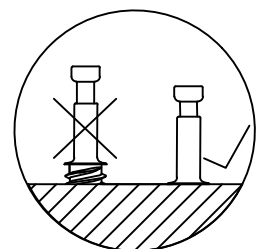
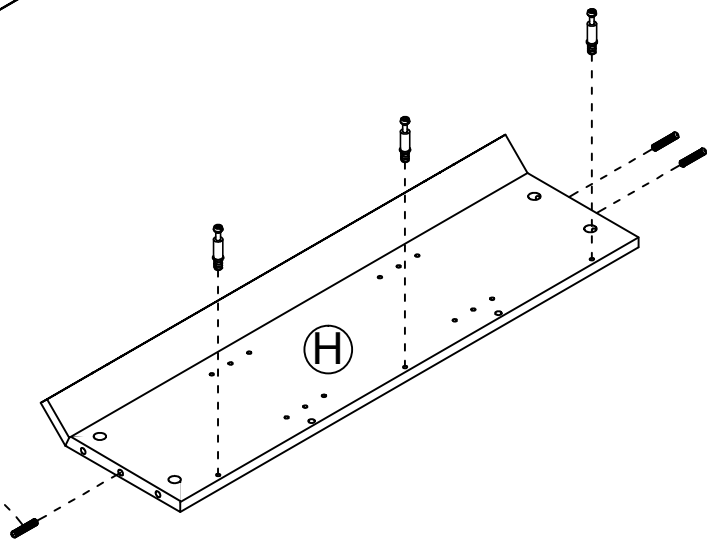
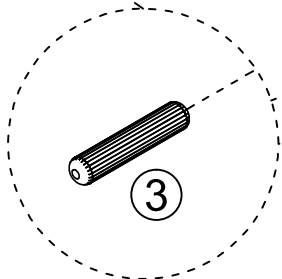
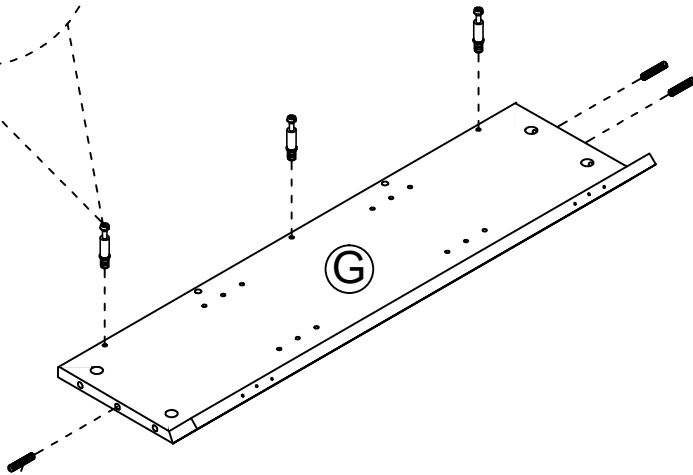
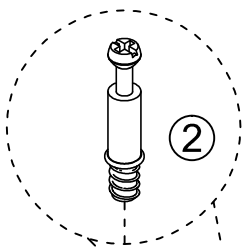

STEP5

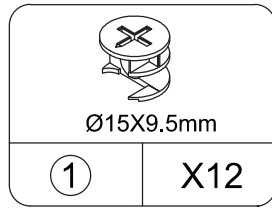
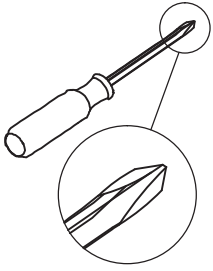

X2

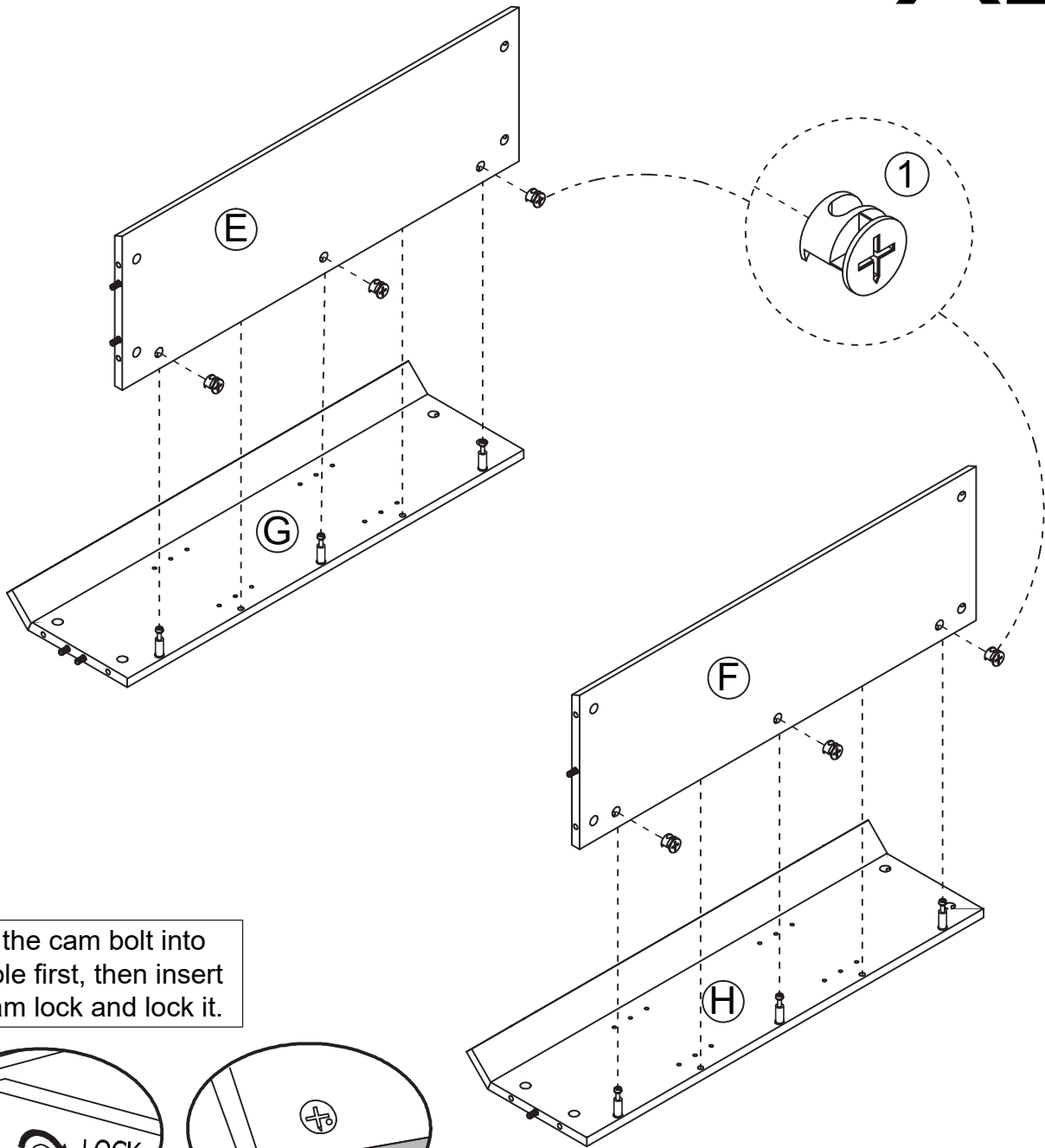

Insert the cam bolt into the hole first, then insert the cam lock and lock it.

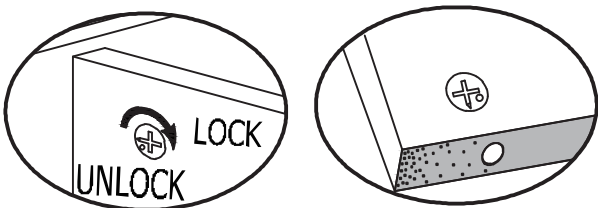

Proper orientation of CAM LOCK

STEP 6

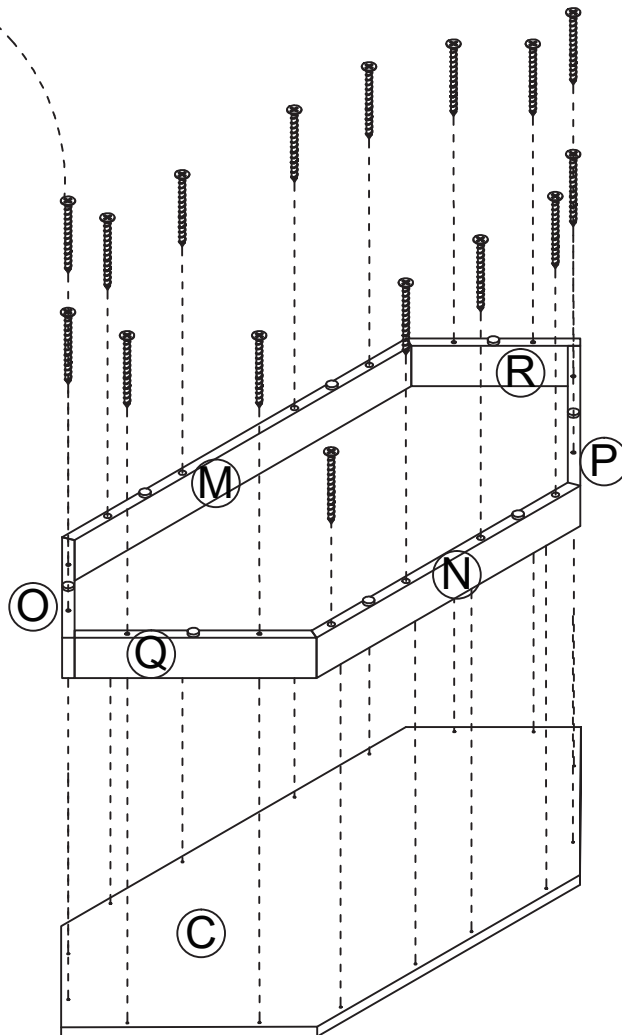
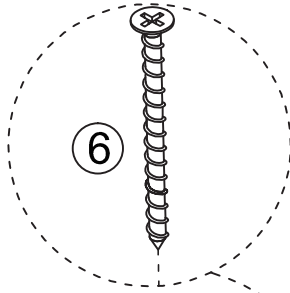
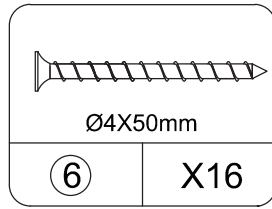
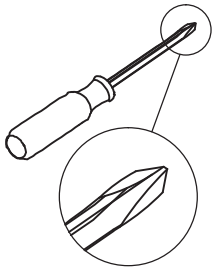

STEP 7

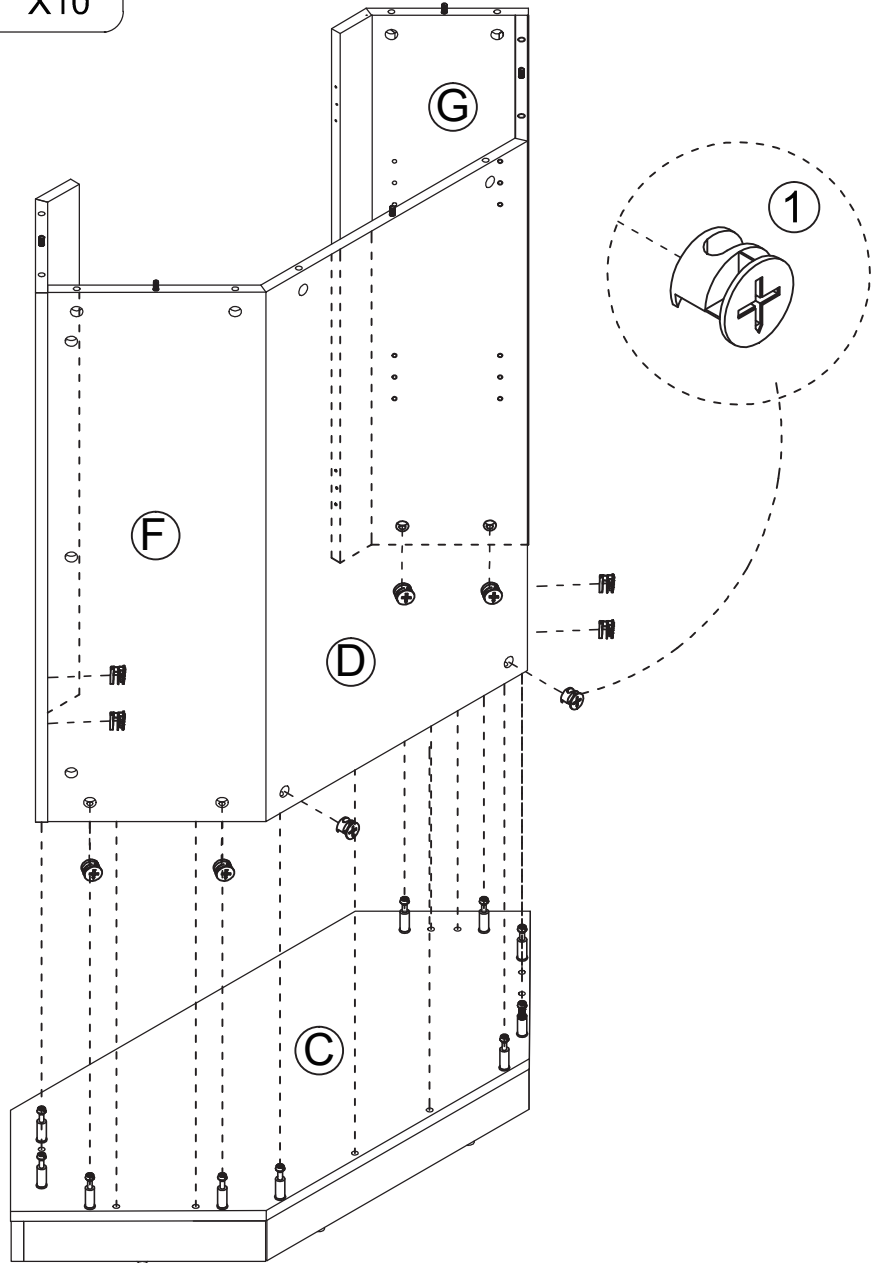
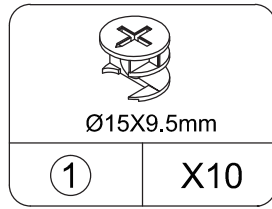
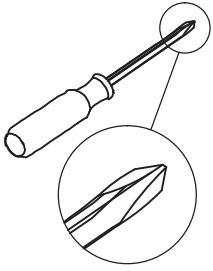

Insert the cam bolt into the hole first, then insert the cam lock and lock it.

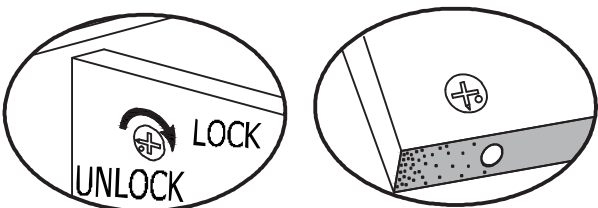

Proper orientation of CAM LOCK

STEP 8

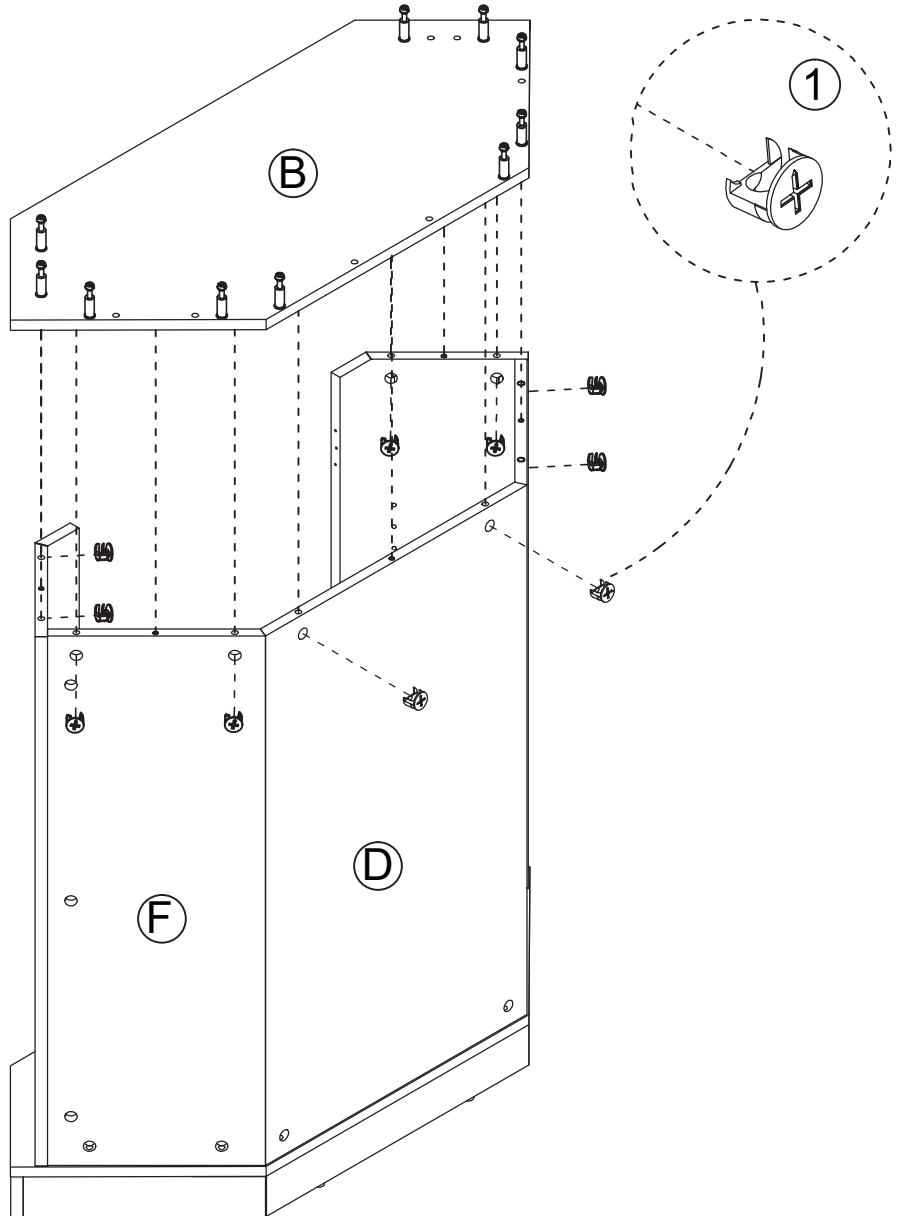
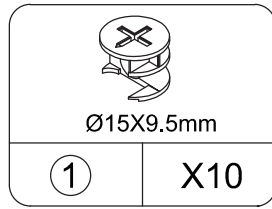
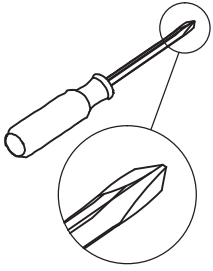

Insert the cam bolt into the hole first, then insert the cam lock and lock it.

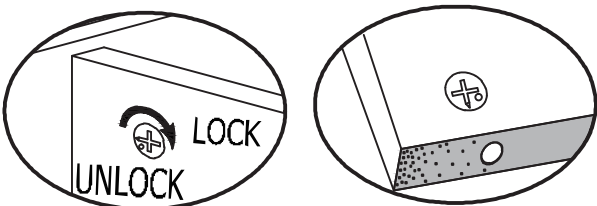

Proper orientation of CAM LOCK

STEP9

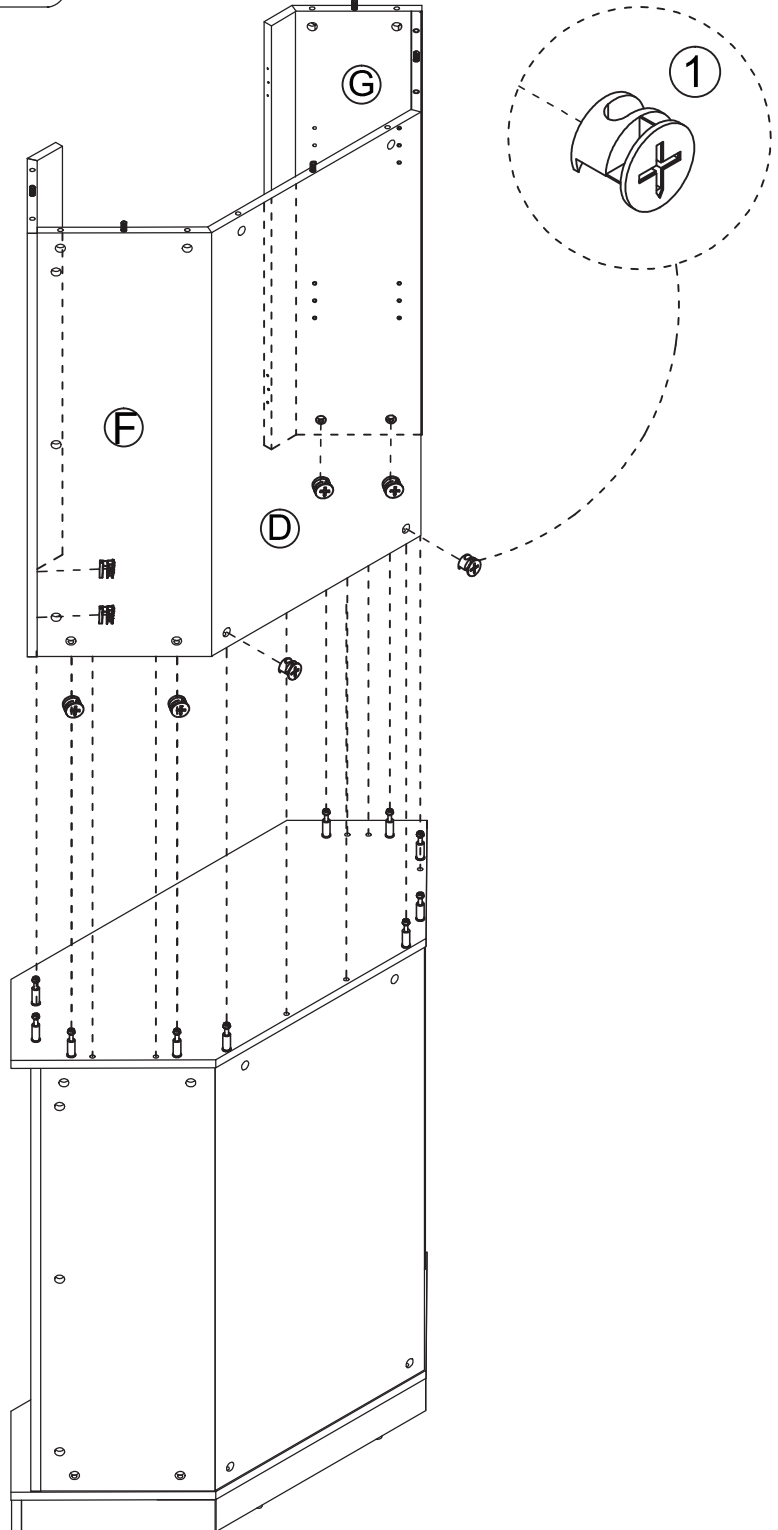
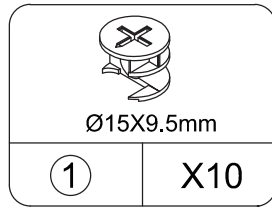
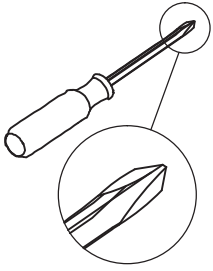

Insert the cam bolt into the hole first, then insert the cam lock and lock it.

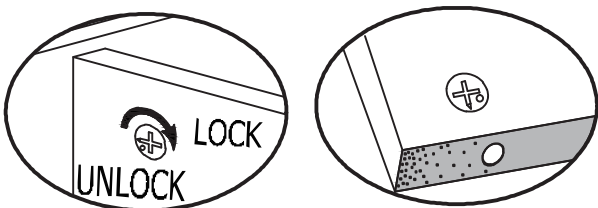

Proper orientation of CAM LOCK

STEP10

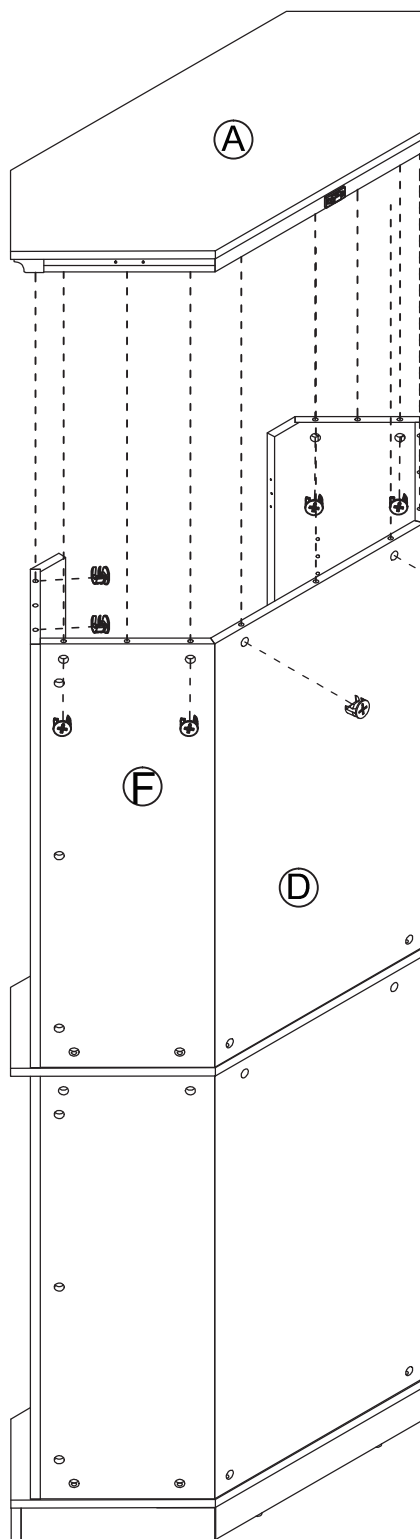
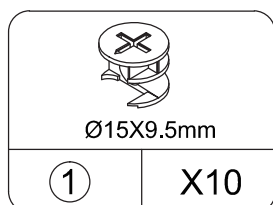
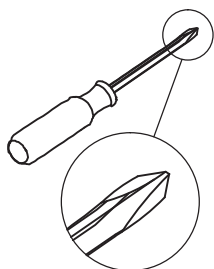

Insert the cam bolt into the hole first, then insert the cam lock and lock it.

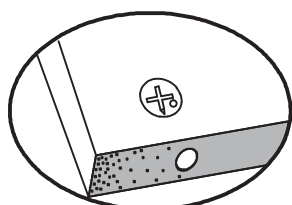

Proper orientation of CAM LOCK

STEP11

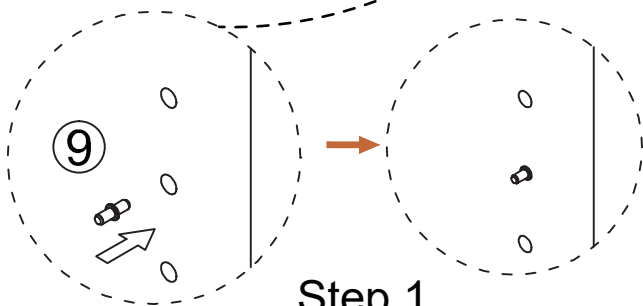
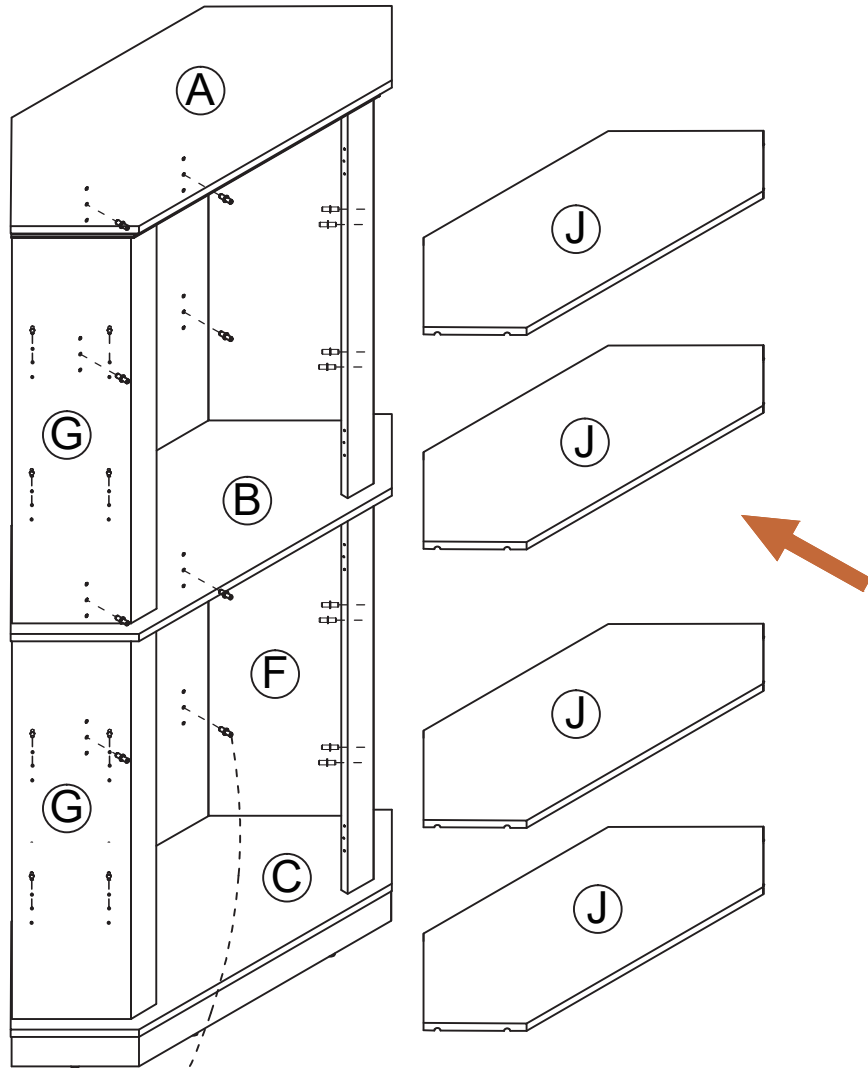
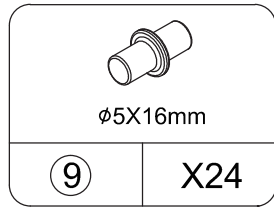
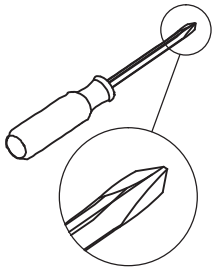

Step 1

Select the desired height and put it in

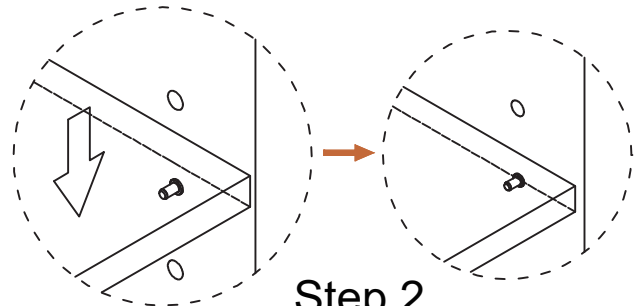

Step 2

Aim the board gaps down

STEP 12

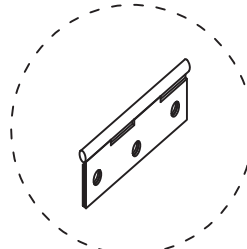
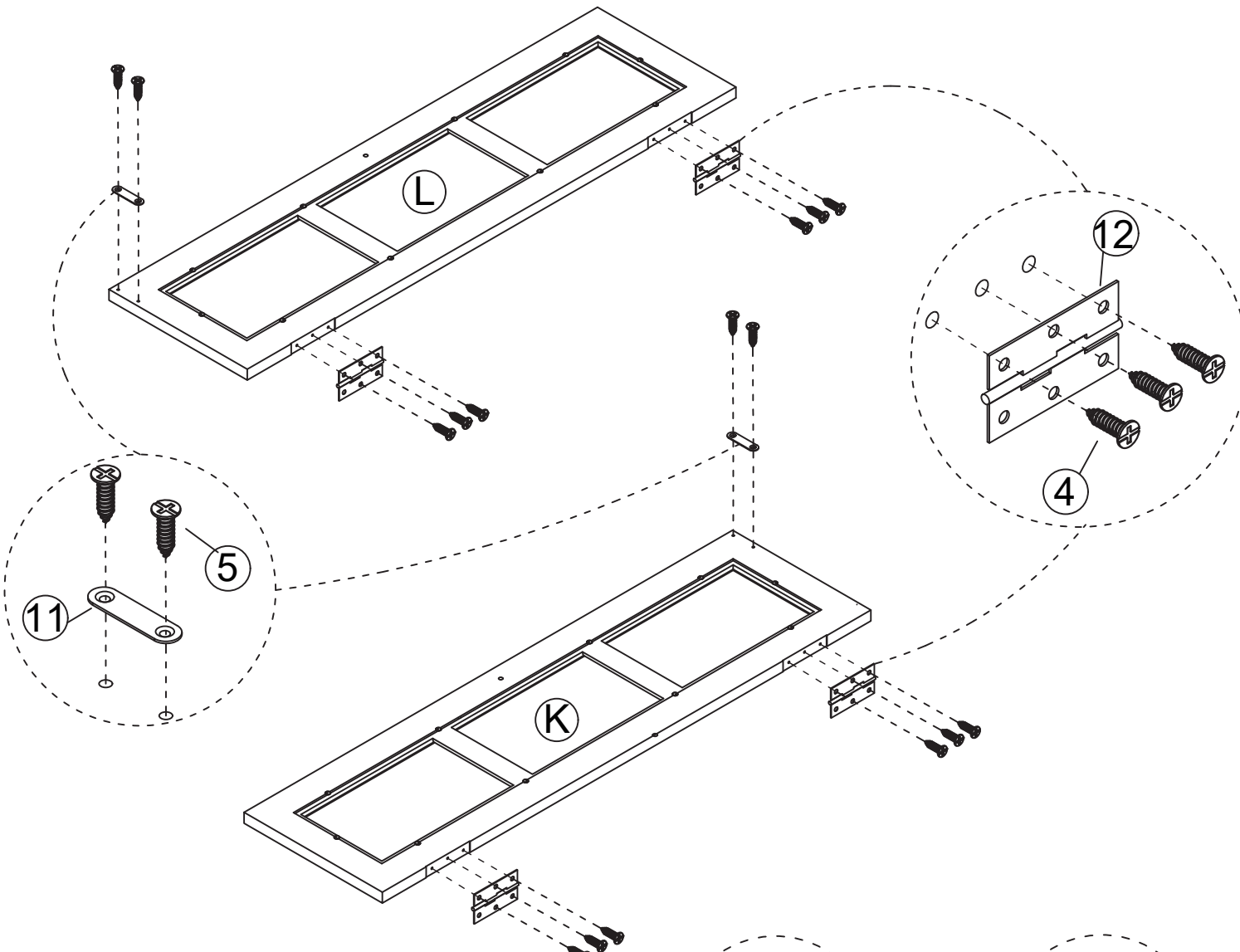
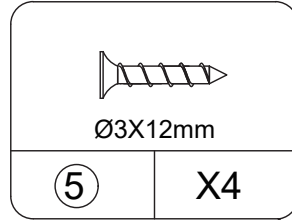
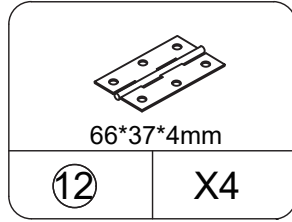
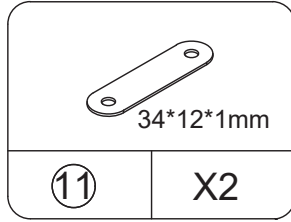
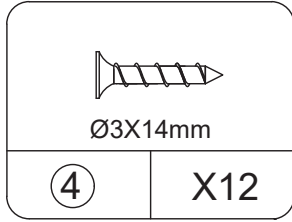
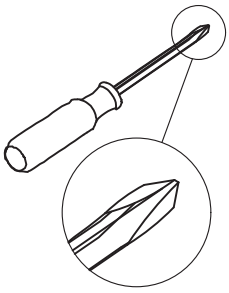

Step 1
Place as shown
in the picture

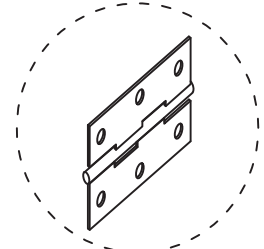

Step 2
Open hinge for
installation

STEP13

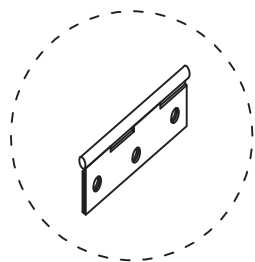
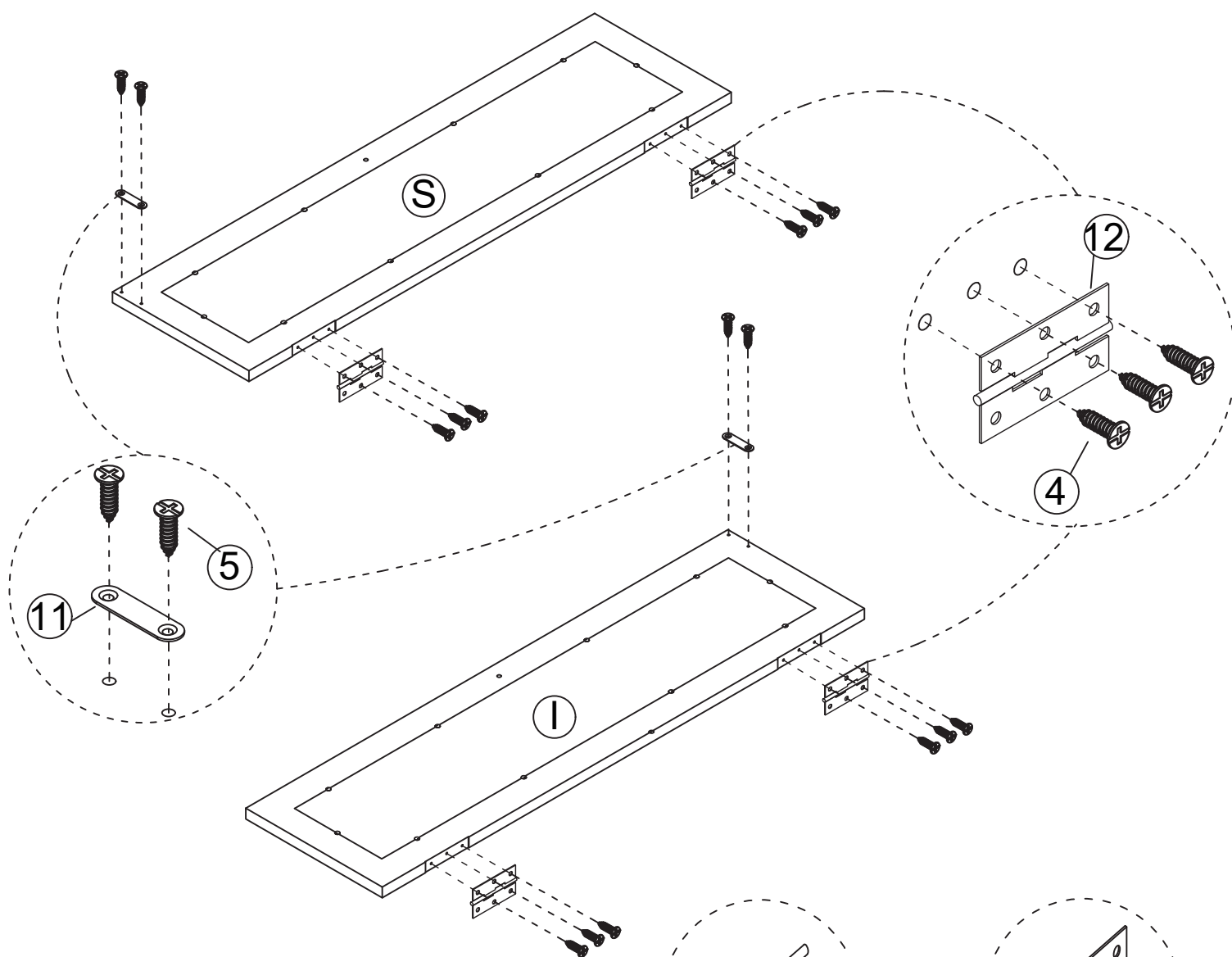
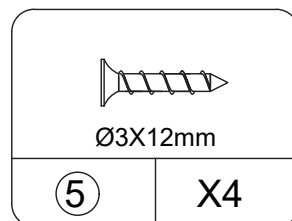
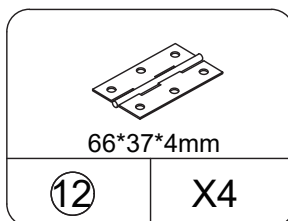
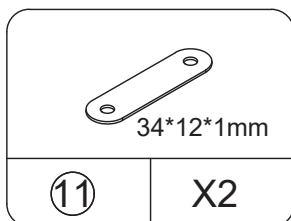
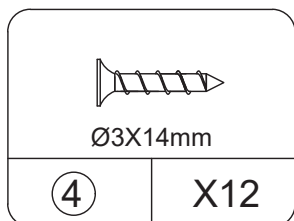
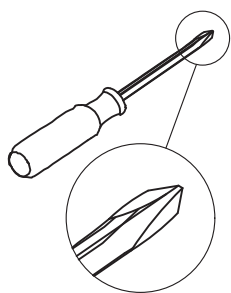

Step 1
Place as shown
in the picture

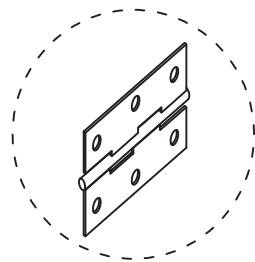

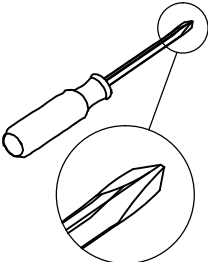

Step 2
Open hinge for
installation

STEP14

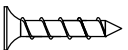

 Ø3X14mm	
④	X12

	
⑦	X2

 M4X19mm	
⑧	X2

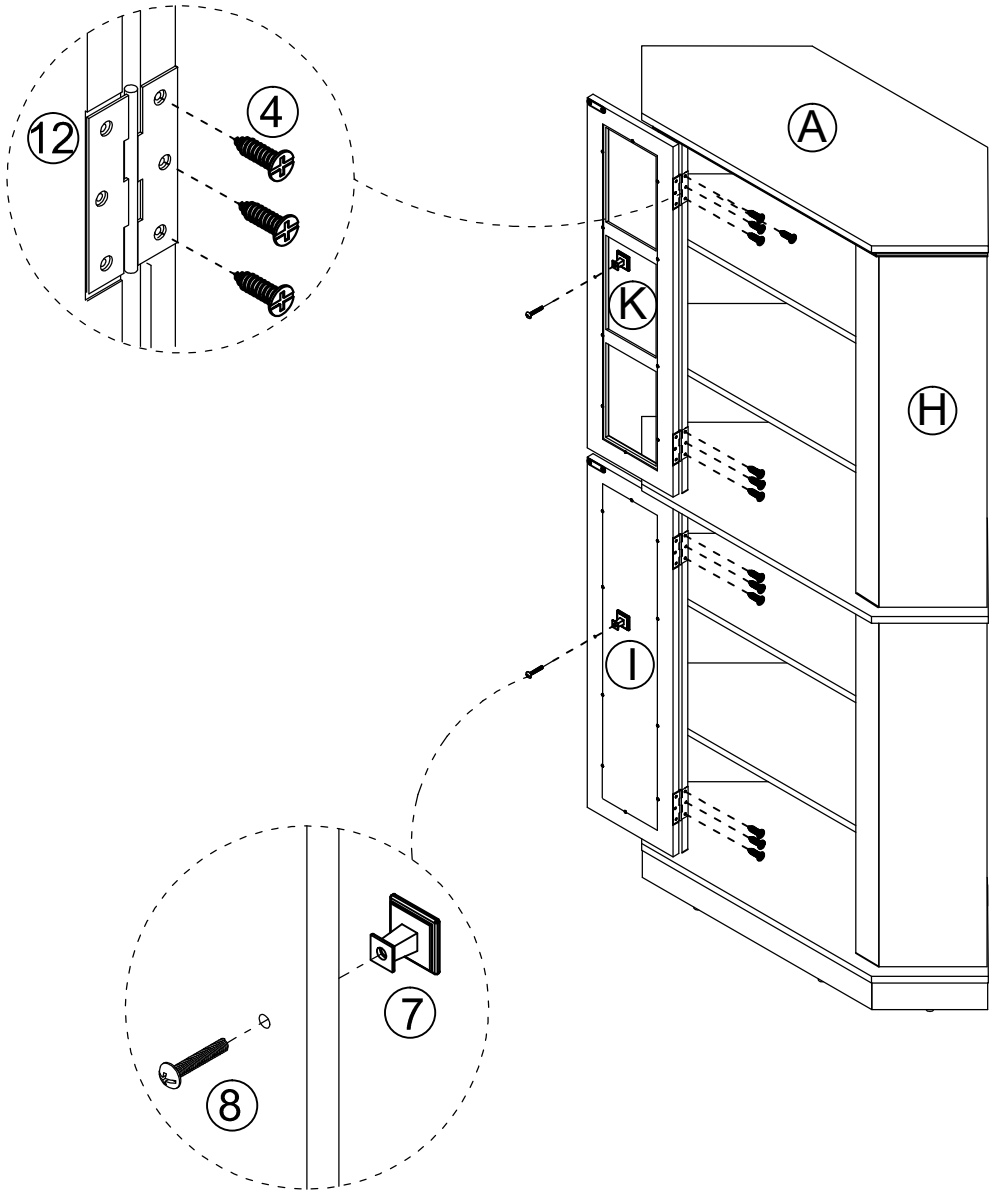

STEP15

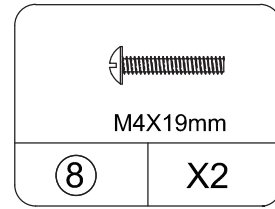
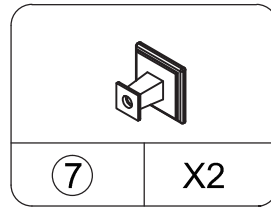
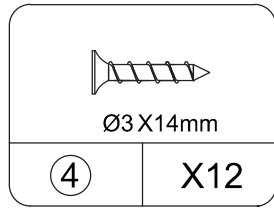
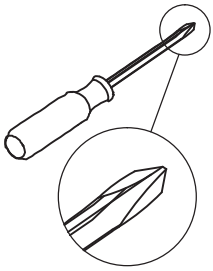

Note: There is no suction between the door panel L, K and No. 10 magnetic magnet. You can loosen screw No. 4, move magnet No. 10, adjust the distance between the front and back of the magnet, so that the door panel is fixed

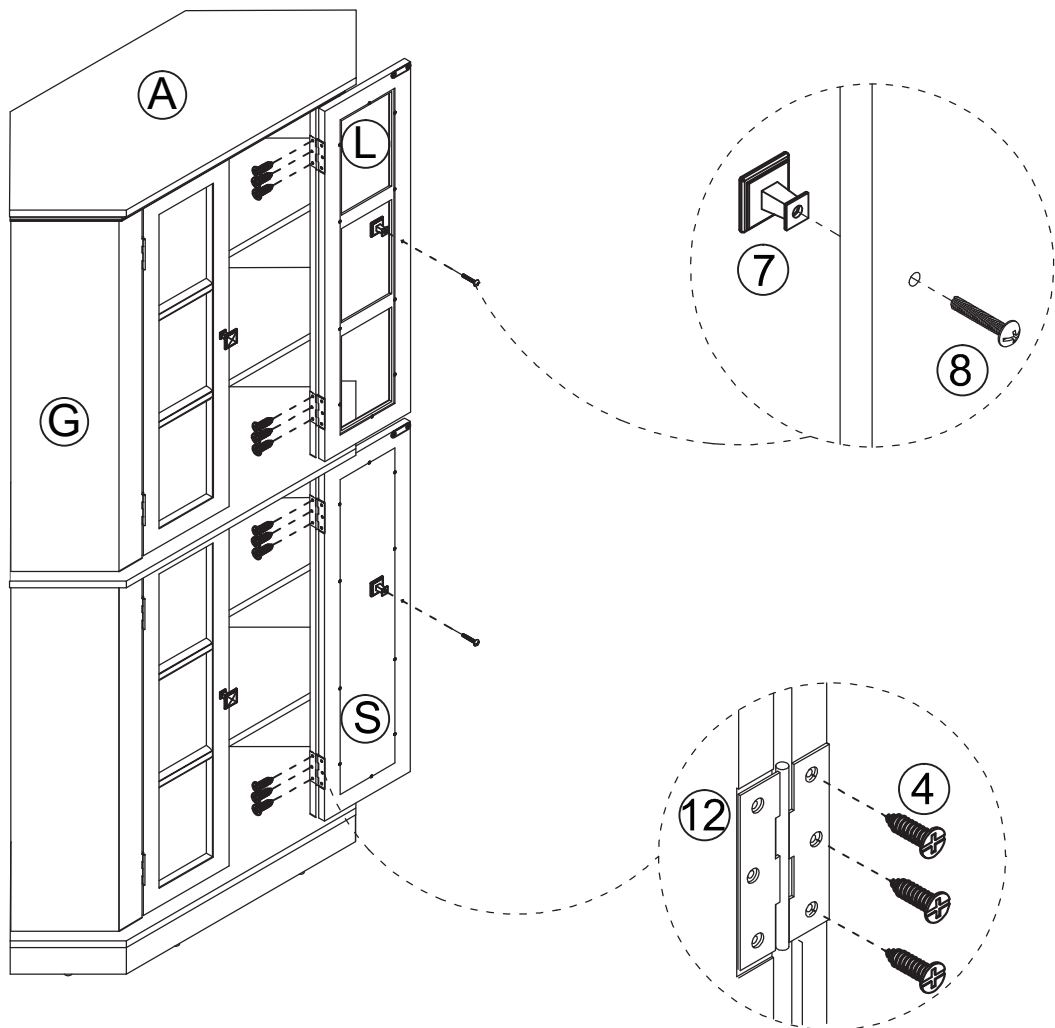

STEP 16

NOTE: The tipping restraint hardware included is for wooden stud wall construction. It must be attached to a wall stud. Depending upon your wall construction different anchor hardware maybe required. Please contact your local hardware store for assistance. Young children can be seriously injured by tipping furniture. You must install the tipping restraint hardware with the unit to prevent the unit from tipping, causing any accidents or damage. The tipping restraints are intended only as a deterrent and are not a substitute for proper adult supervision. The tipping restraints are not earthquake restraints. If you wish to add the extra security of earthquake restraints, they must be purchased and installed separately.

You can choose the following two ways to install the anti-tipping device according to the location

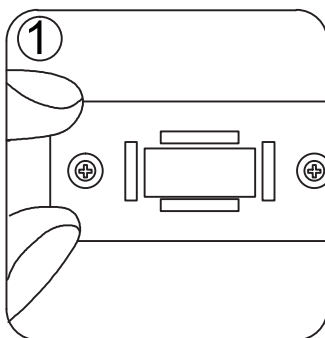

1. make mark on the wall

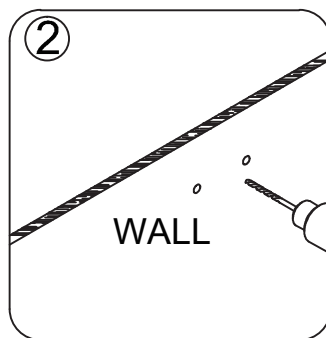

2. drill two $\varnothing 6$ holes on the wall

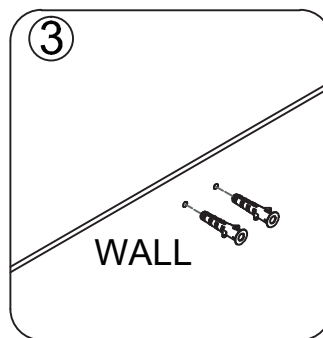

3. put two anchors in the holes

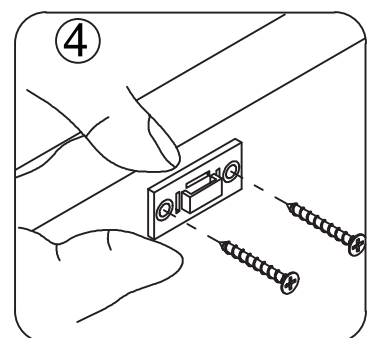

4. fix the device on the wall by the long screws

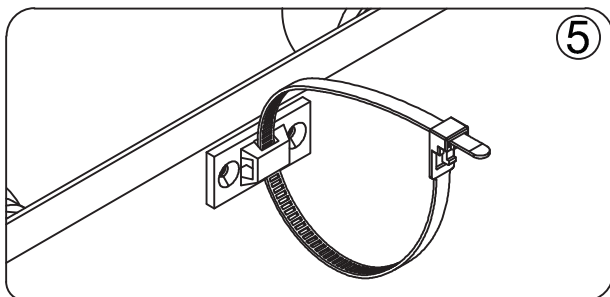

5. Push the cabinet close to the wall so that the two bases are close to each other, and then put on nylon tie to tighten it.

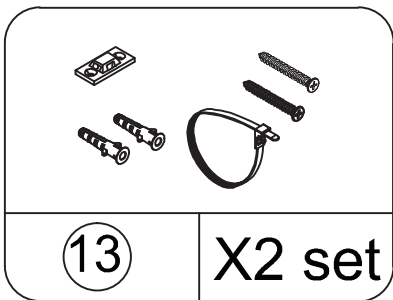
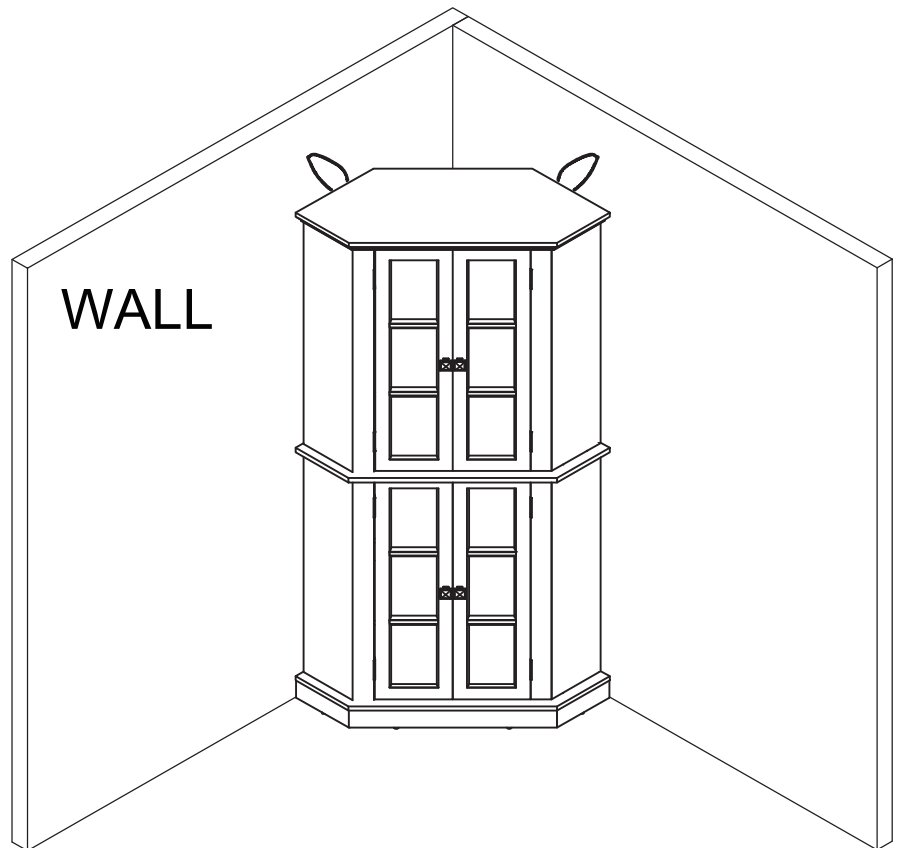
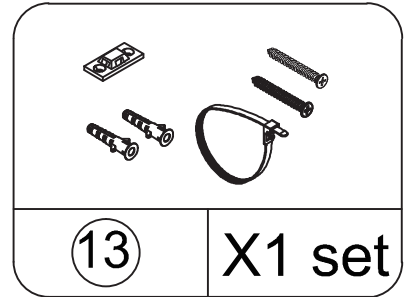
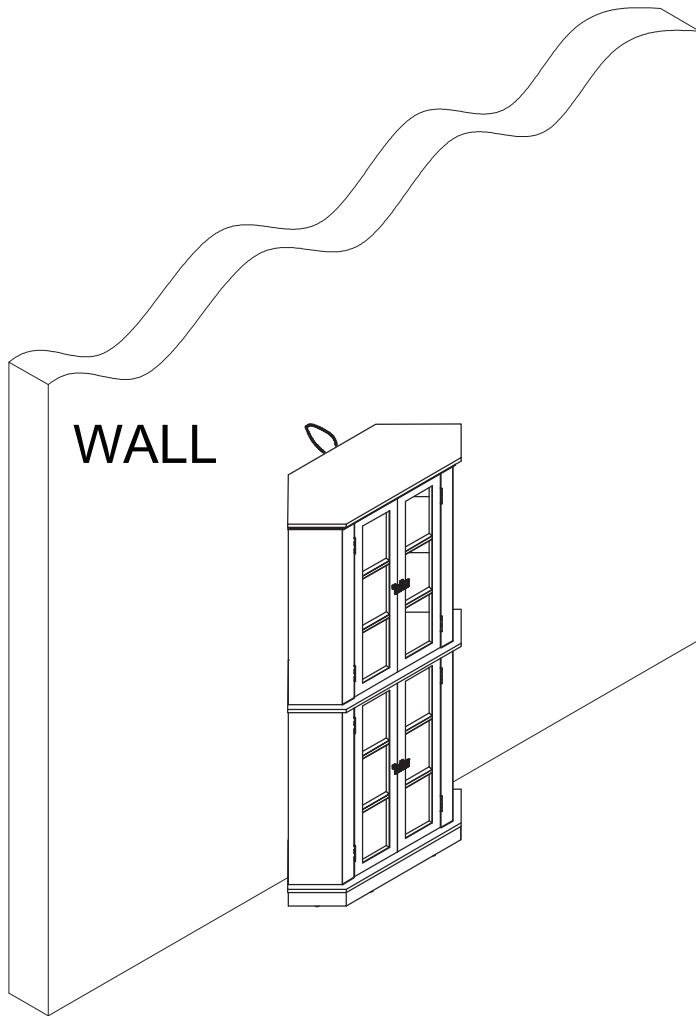

AFTER-SALE SERVICE

If you have any suggestions for our products or find that the products have quality problems, please contact us first, our after-sales team will reply you within 24 hours, and we will do our best to give you solutions until you are satisfied.

Guaranteed Customer Service

Your shopping experience is very important to us!
Feel unsatisfied? **Contact us!**
Have any questions? **Contact us!**

Wanna share how wonderful our furniture matches your home?
Share your pictures with us.
Any suggestions? **Contact us!**