









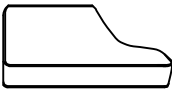

# ASSEMBLY INSTRUCTION

## SOFA

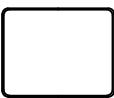
**NOTE: Do not use power tools for assembly. Power tools increase the risk of over tightening which leads to splitting or cracking the wood.**

### COMPONENT LIST (SOFA)

NO.	DRAWING	QTY	DESCRIPTION
A		1	SEAT
B		1	LSF SEAT CUSHION
C		1	MIDDLE SEAT CUSHION
D		1	RSF SEAT CUSHION
E		1	LSF BACK CUSHION
F		1	MIDDLE BACK CUSHION
G		1	RSF BACK CUSHION
H		5	PLASTIC LEGS 3.74"x2.75"x3.14"
I		5	WASHERS 1.85"x0.39"x0.07"
K		4	PILLOWS 20"x20"

**STEP# 1**

Turn Plastic Leg (H) and Washers (I) until fully tightened.

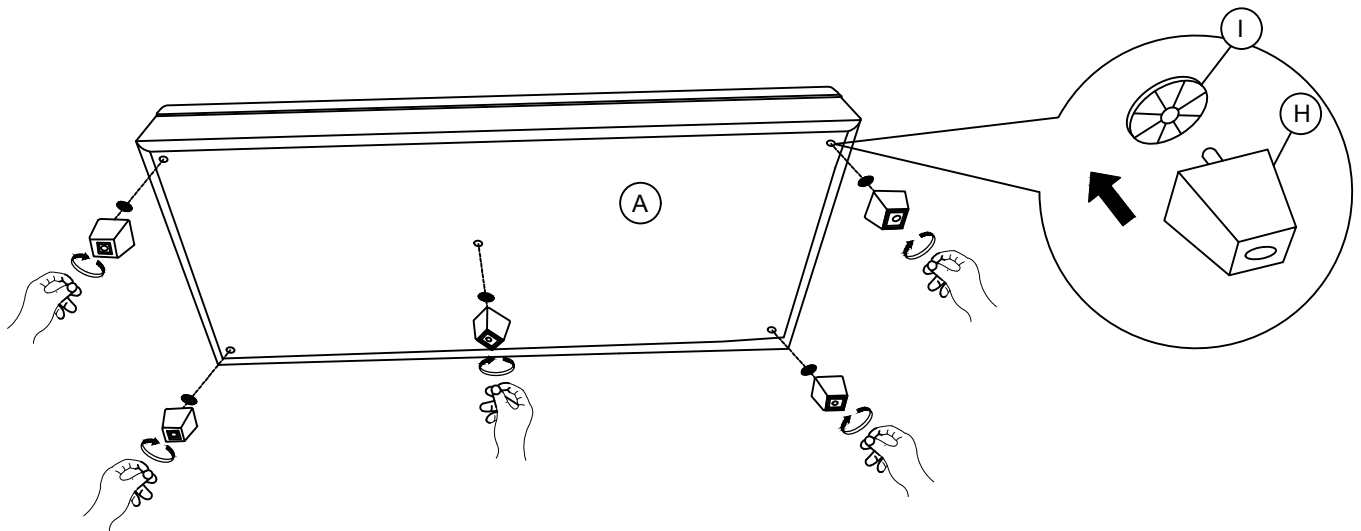

**STEP# 2**

Attach LSF Seat Cushion (B), Middle Seat Cushion (C) & RSF Seat Cushion (D) to the Seat (A).

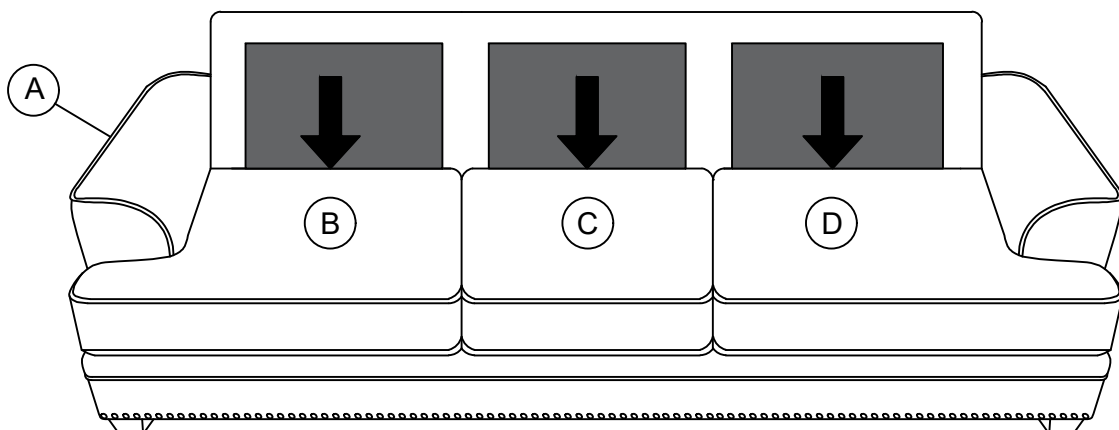

**STEP# 3**

Attach LSF Back Cushion (E), Middle Back Cushion (F) & RSF Back Cushion (G) to the Seat (A) .

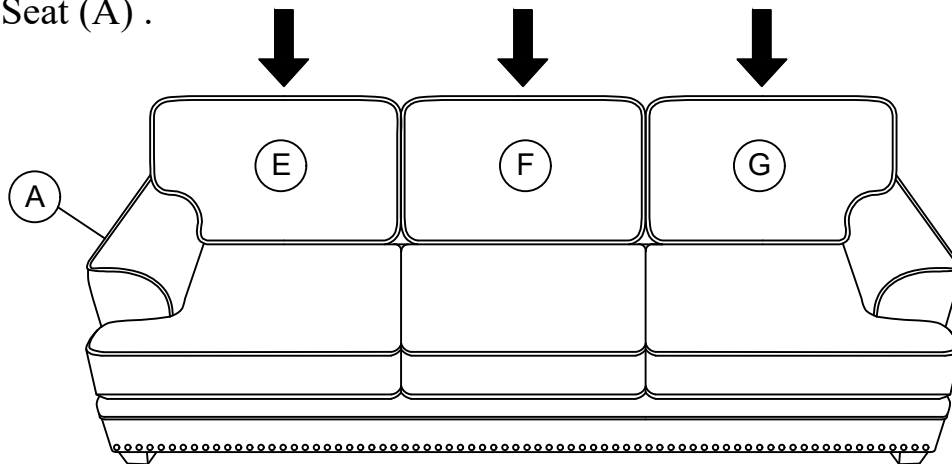

**STEP# 3**

Completed .

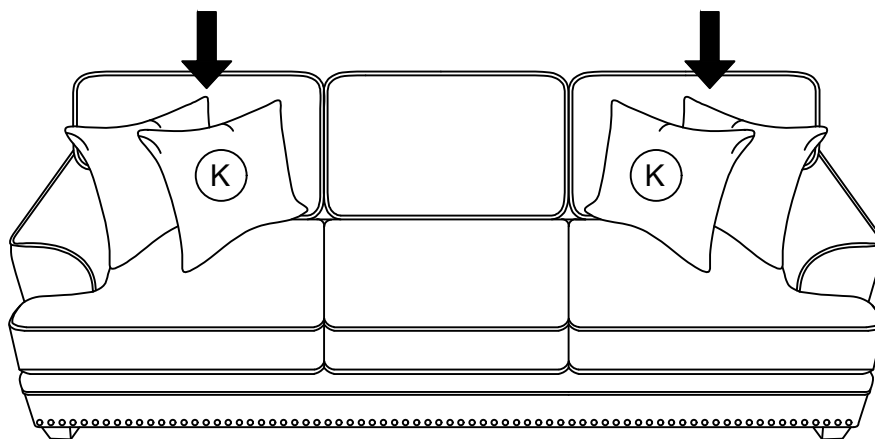

**Care Instruction for Textured Furniture.**

In order to maintain the original appearance of your Textured furniture, please follow below simple care procedures:

- Avoid exposing furniture directly to sunlight or heating and air conditioning outlets. Sunlight and/or exposure to heating and air conditioning outlets will fade/damage Textured.
- Do not place your Textured furniture too close to windows, radiators, or vents.
- Vacuum or wipe with a soft brush to remove dust.
- Hardware may loosen over time. Periodically check to make sure all connection are tight, Re-tighten if necessary.



**For items use on wooden floor, hard surfaces or carpets, it is recommended to install protective pads under all legs and supports to avoid/prevent from damages/scratches and discoloration.**