

ASSEMBLY INSTRUCTION

PARTS

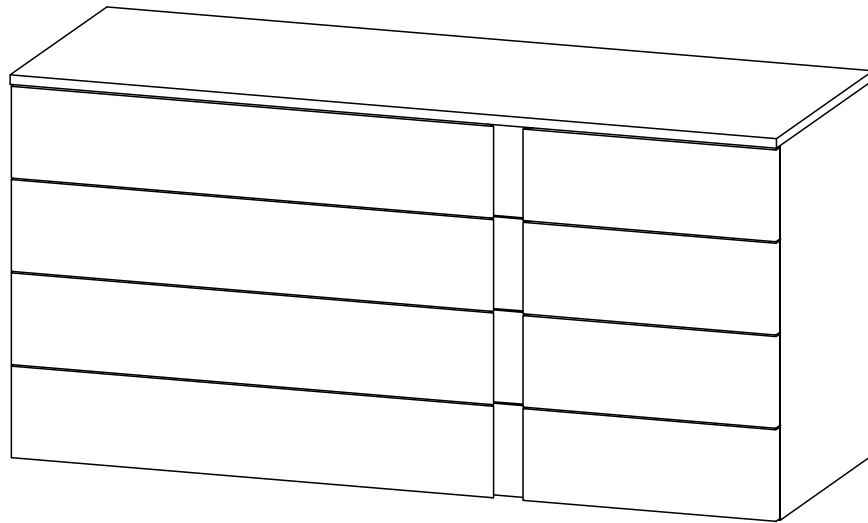

① x 1

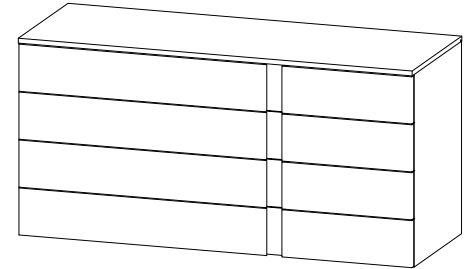

② x 6

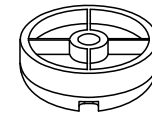

③ x 6



HARDWARE

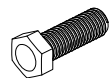

M8x25mm

Ⓐ x 6

TOOL

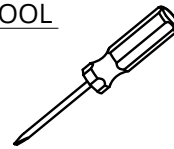

Ⓑ x 1

ASSEMBLY INSTRUCTION

STEP 1

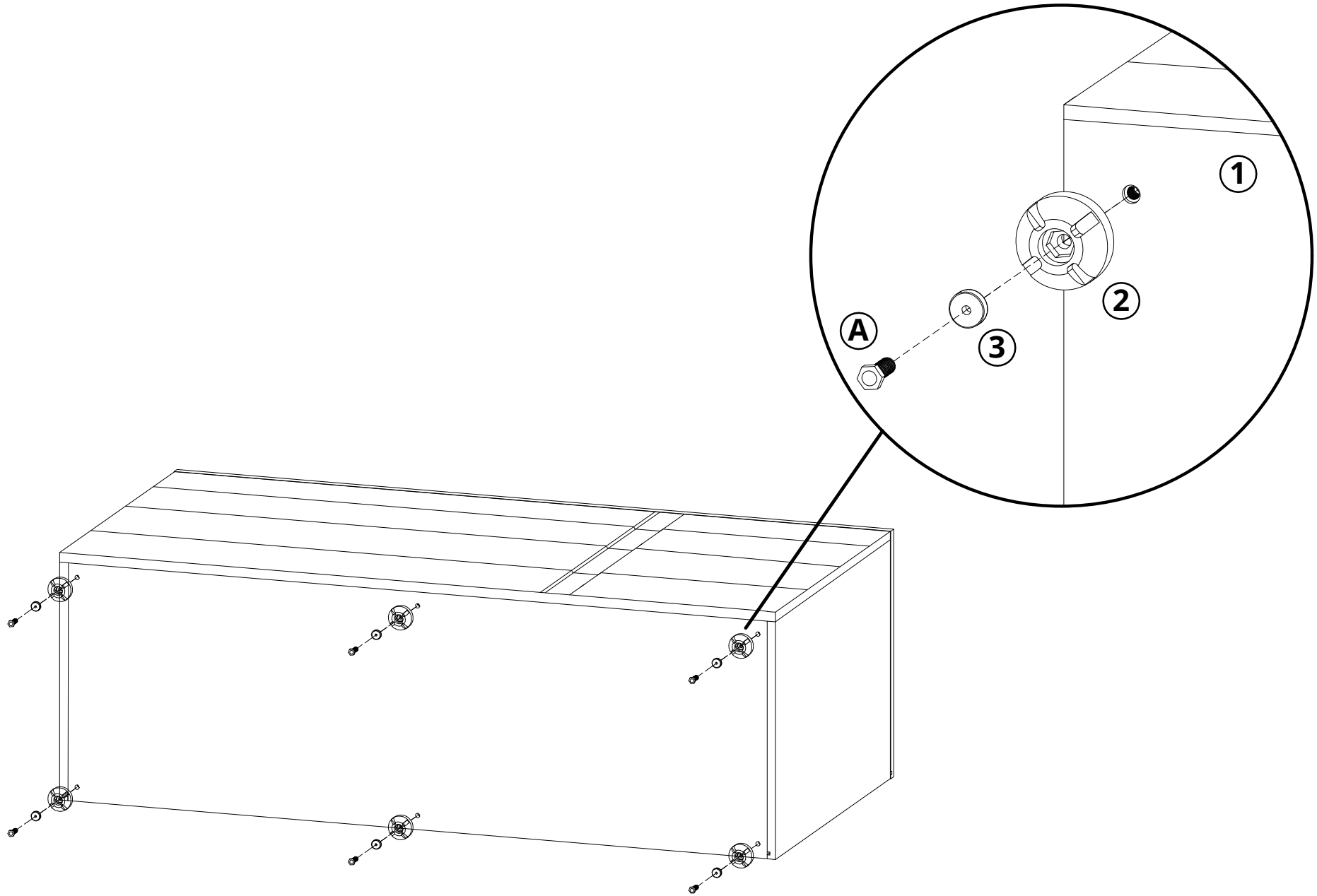

ASSEMBLY INSTRUCTION

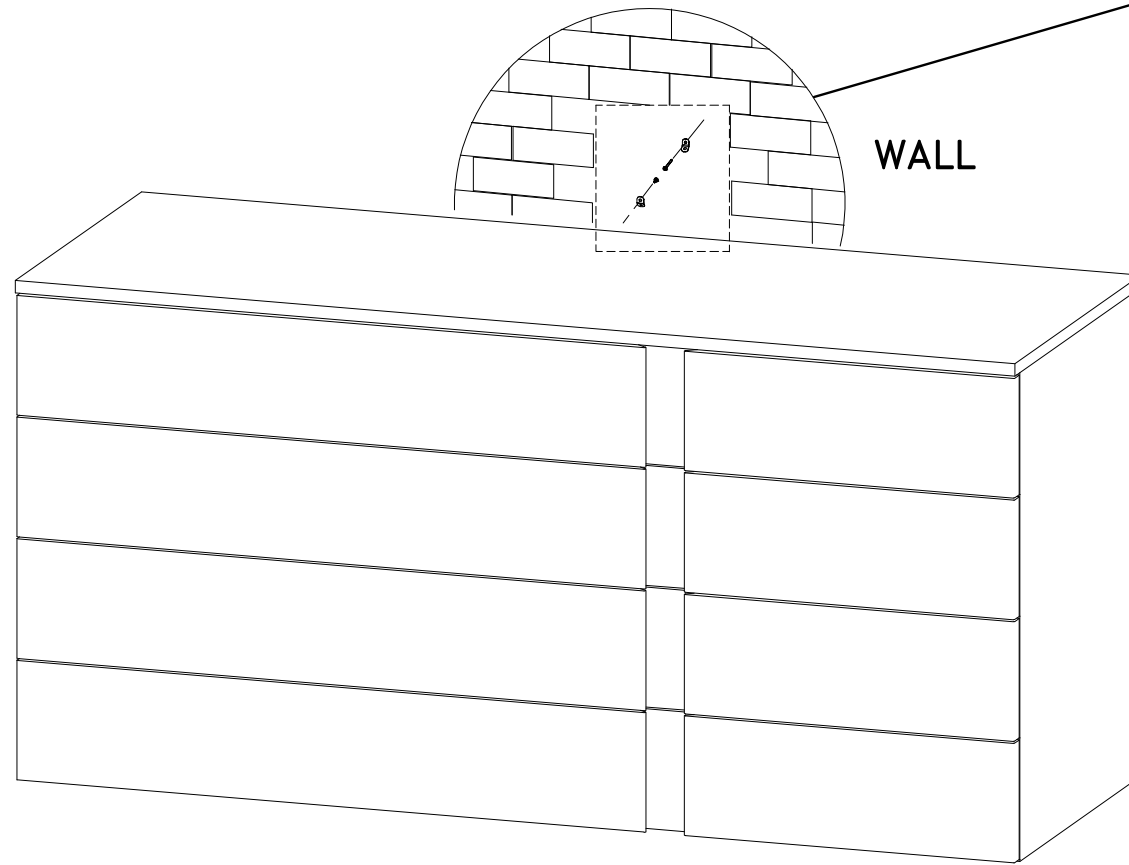

STEP 2

