

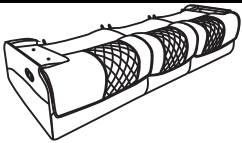

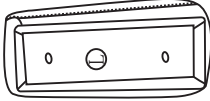

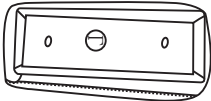
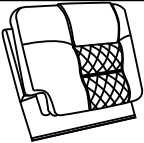

ASSEMBLY INSTRUCTION

DOUBLE RECLINING SOFA WITH DROP-DOWN CUP HOLDERS, RECEPTACLES AND USB PORT

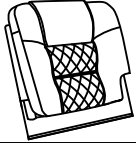
NOTE: Do not use power tools for assembly. Power tools increase the risk of over tightening which leads to splitting or cracking the wood.

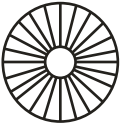
COMPONENT LIST (SOFA)

NO.	DRAWING	QTY	DESCRIPTION
A		1	SEAT
B		1	LSF ARM
C		1	RSF ARM
D		1	LSF BACK REST
E		1	MIDDLE BACK REST
F		1	RSF BACK REST
G		4	THREADED BOLT M6*6CM
H		4	WASHER
K		4	STAR KNOB

STEP# 4

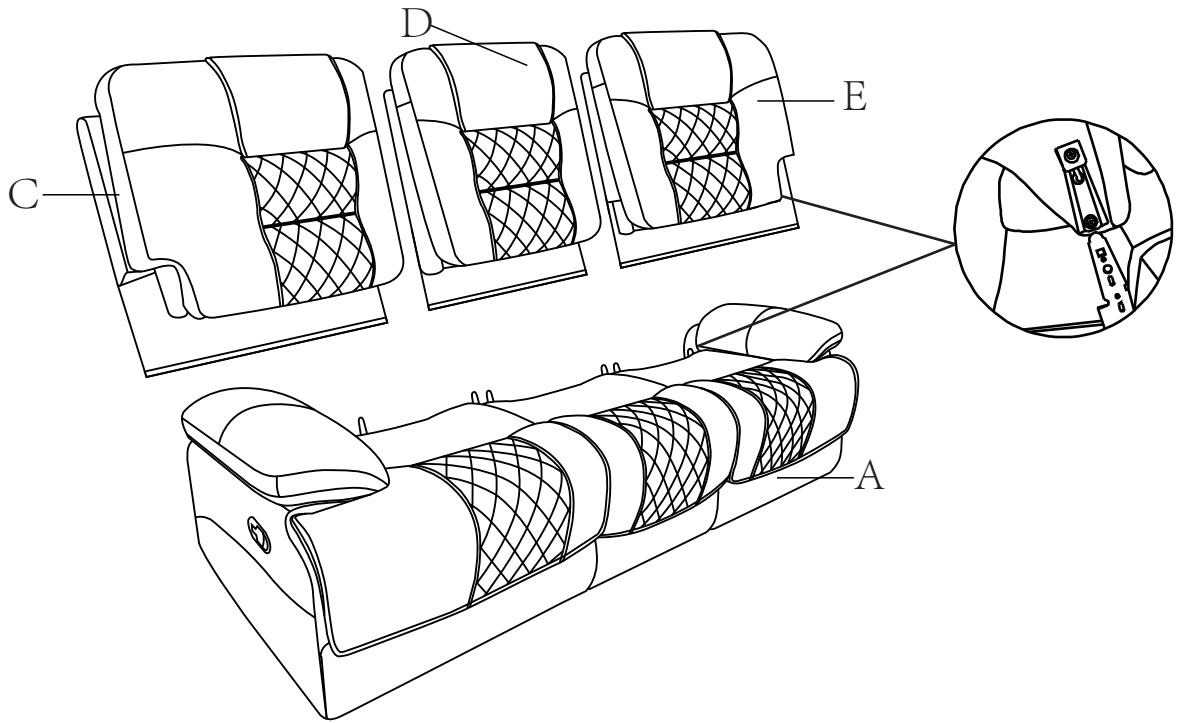

STEP#5

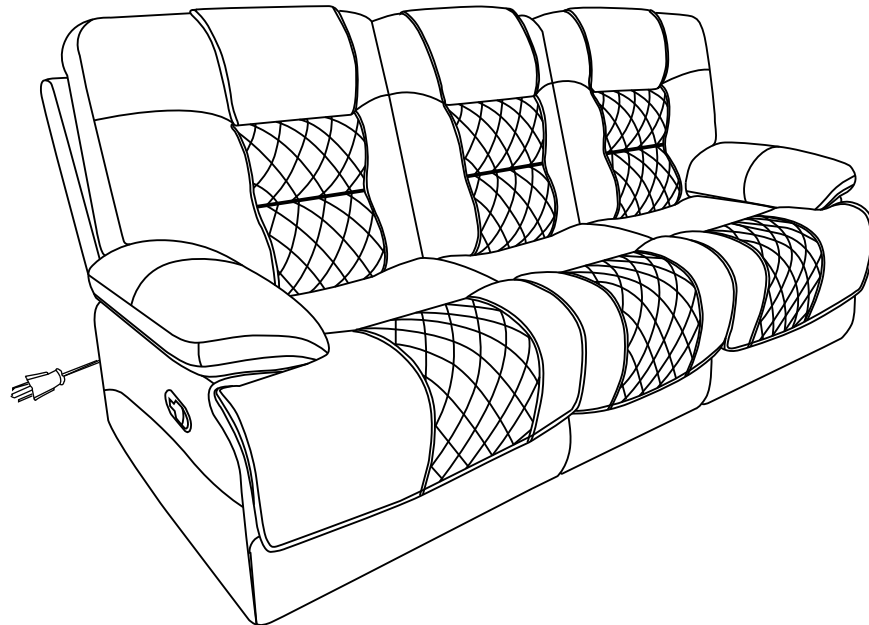

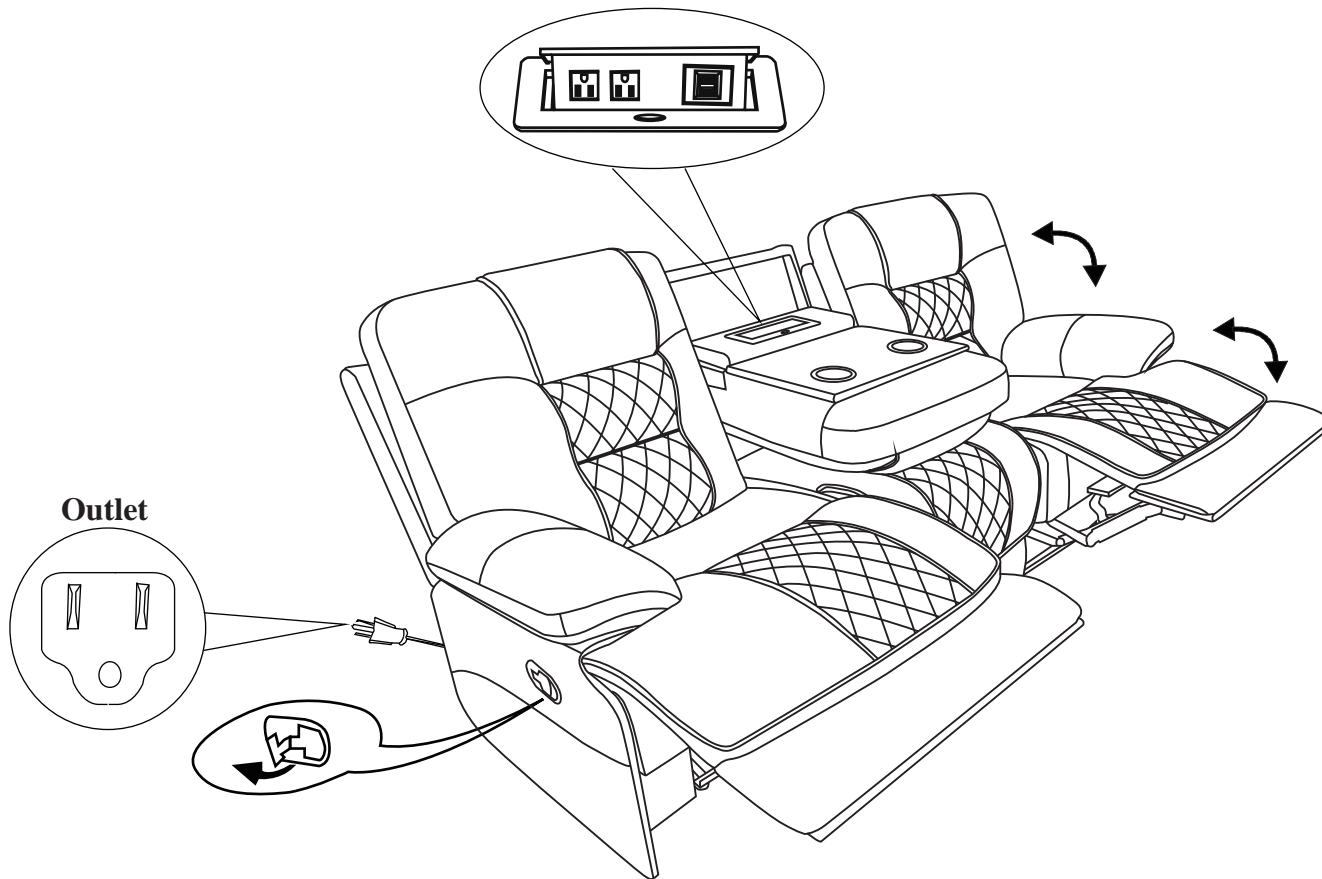

Care Instruction for Leather air Furniture.

In order to maintain the original appearance of your leather air furniture, please follow below simple care procedures:

- Avoid exposing furniture directly to sunlight or heating and air conditioning outlets. Sunlight and/or exposure to heating and air conditioning outlets will fade/damage leather air furniture .
- Do not place your upholstered furniture too close to windows, radiators, or vents and be sure to use window, radiators, or vents.
- Vacuum or wipe with a soft brush to remove dust.



For items used on wooden floor, hard surfaces or carpets, it is recommended to install protective pads under all legs supports to avoid/prevent from damages/ scratches discoloration.