

ASSEMBLY INSTRUCTIONS

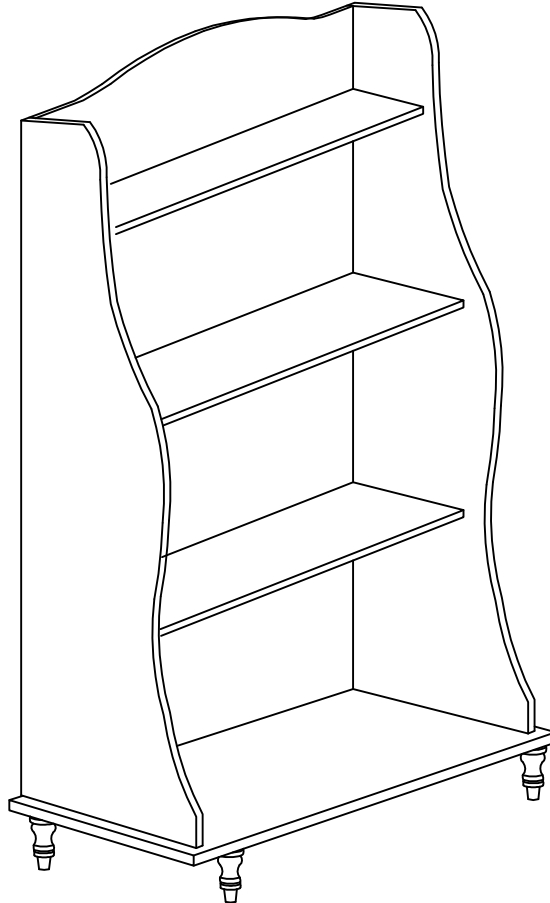





Tall Bookcase





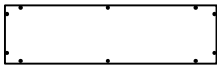
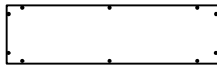
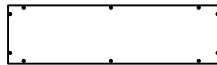

NOTE TO CUSTOMERS:

- For ease and speed of assembly we recommend that before you commence each step of the assembly that you identify all the parts required to complete that step.
- We recommend that where possible you allow sufficient space to assemble the item as close as possible to the place where it will be once assembled.
- For the protection of your furniture we recommend that the product is placed on protected surfaces during assembly to prevent any damage.
- During assembly do not over tighten ,as this may damage the product.
- Please ensure you retain all the product packaging until the item completely assembled.
- Please periodically check all fittings and re-tighten as necessary.
- Never allow any liquids to remain on your furniture as absorption can cause the wood to warp or the finish to de-laminate.
- It is recommended that this item should be assembled by two adults.

Part List

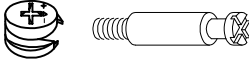
<p>A1(L&R). Quantity of 2</p>  <p>Side Panel</p>	<p>A2(L&R). Quantity of 1</p>  <p>Top Scallop Back</p>	<p>A3. Quantity of 1</p>  <p>Top Shelf</p>	<p>A4. Quantity of 2</p>  <p>Shelf</p>
<p>A5. Quantity of 1</p>  <p>Bottom Panel</p>	<p>A6. Quantity of 1</p>  <p>Upper Back Panel</p>	<p>A7. Quantity of 1</p>  <p>Middle Back Panel</p>	<p>A8. Quantity of 1</p>  <p>Lower Back Panel</p>
<p>A9. Quantity of 4</p>  <p>Leg</p>			

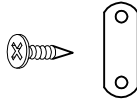
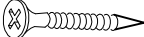
Hardware List

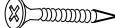
<p>B1. Quantity of 8</p>  <p>Wood Dowel</p>	<p>B2. Quantity of 14</p>  <p>Camlock</p>	<p>B3. Quantity of 24</p>  <p>Back Screw</p>	<p>B4. Quantity of 2</p>  <p>Plate with Screw</p>
<p>B5. Quantity of 4</p>  <p>Long Screw</p>	<p>B6. Quantity of 2</p>  <p>Anchor with Screw</p>	<p>B7. Quantity of 2</p>  <p>Short Screw</p>	

Note:

- Read these instructions carefully before assembling.
- Tools required : Phillips screwdriver, flat screwdriver.
- Find a clean, smooth area on which to work , such as a carpet, in order to avoid scratching the wood surfaces.
- Wait to dispose of the packing material until assembly is complete and all parts and hardware are accounted for.
- Two or more people might be required for assembly.



To use Dowels:

1. Add glue (about $\frac{1}{4}$ full) in the hole(s) of each board to be joined.
2. Insert the Dowel(s) and join boards.
3. Wipe excess glue with a damp paper towel.

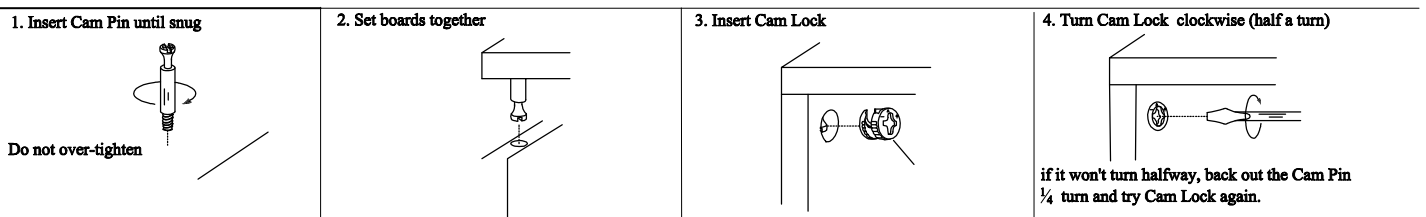
To use Cam Locks:



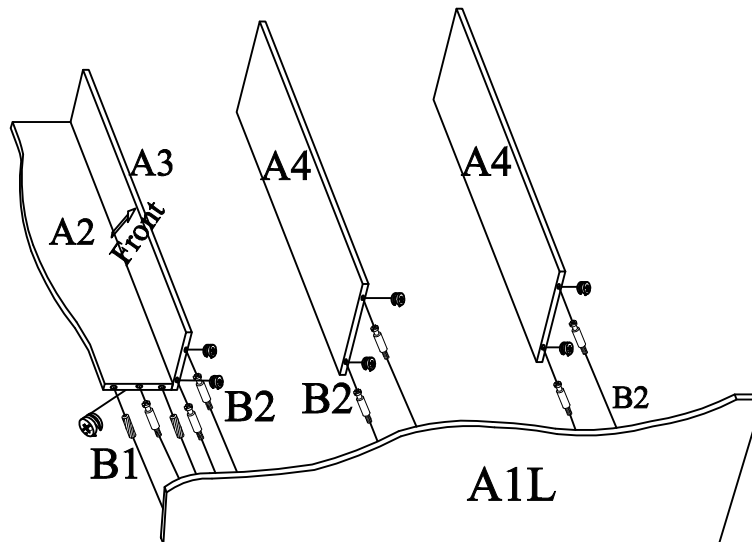

Step 1

B1		2pcs
B2		7sets



Assemble Top Scallop Back A2 and Shelves A3, A4 to Side Panel A1L using Wood Dowels B1 and Camlocks B2.

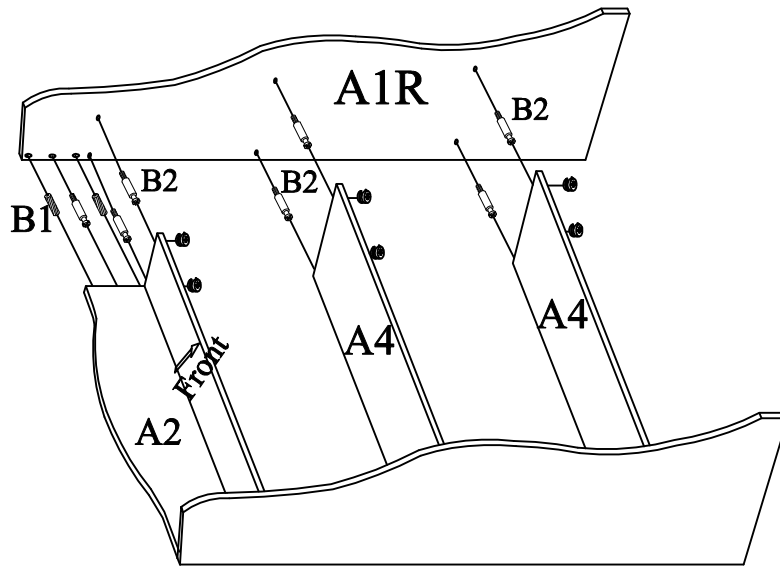

Step 2

B1		2pcs
B2		7sets



Assemble Side Panel A1R to Top Scallop Back A2 and Shelves A3, A4 using Wood Dowels B1 and Camlocks B2.

Step 3

B1		4pcs
B5		4pcs

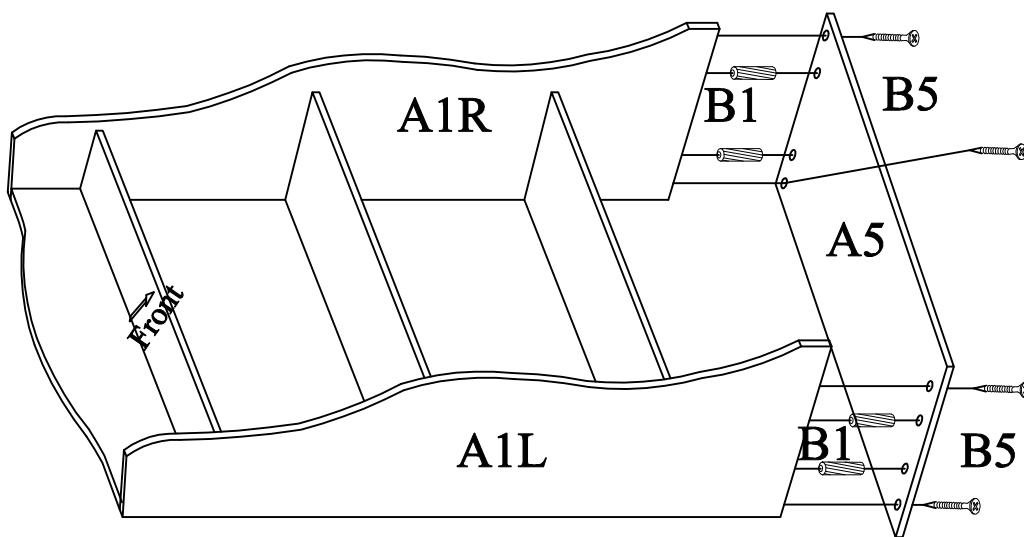

Assemble Bottom Panel A5 to Side Panels A1 (R&L) using Wood Dowels B1 and Screws B5.

Step 4

B7  2pcs

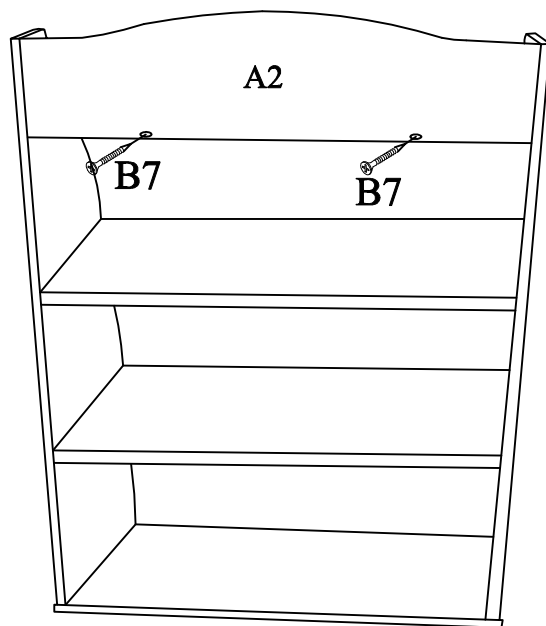

Fasten Top Scallop Back A2 to Shelf A3 from the back using Screws B7.

Step 5

B3  24pcs

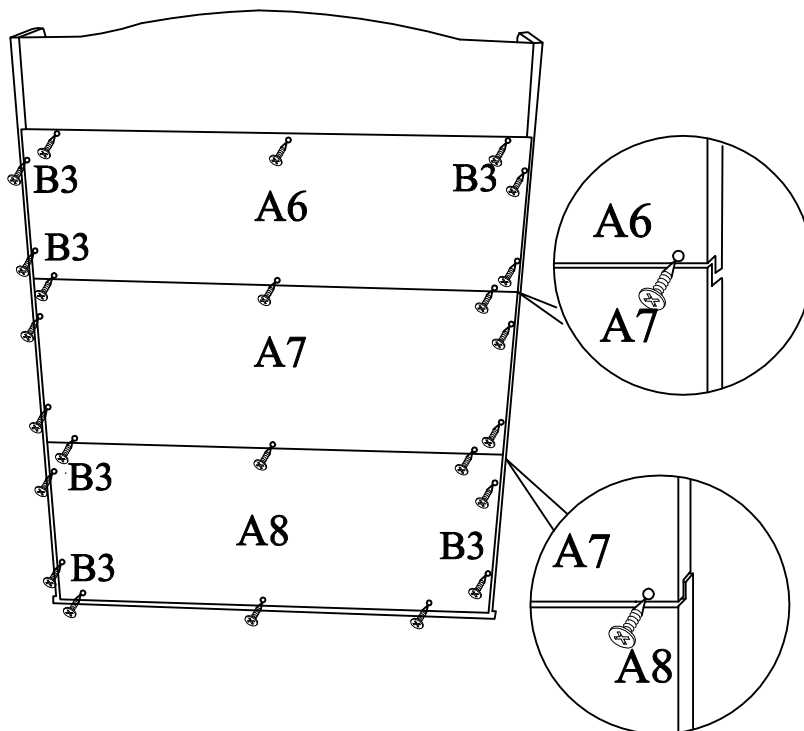

Assemble Back Panels A6, A7, A8 to the tall bookcase using Screws B3.

Step 6

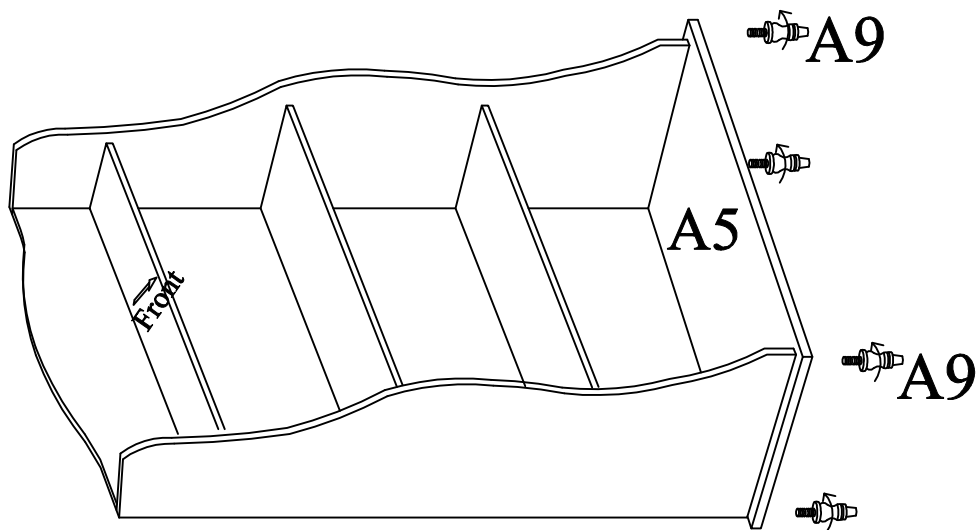

Screw Legs A9 onto Bottom Panel A5.

Step 7

B4   2sets

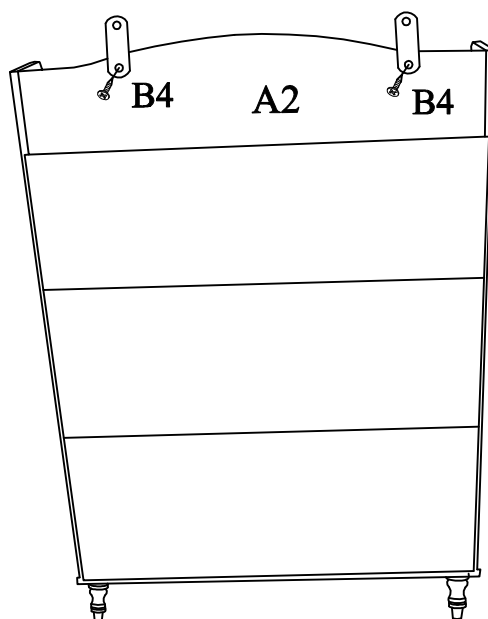

Attach Metal Plates B4 to Top Scallop Back A2 with including screws.

Step 8

B6   2sets

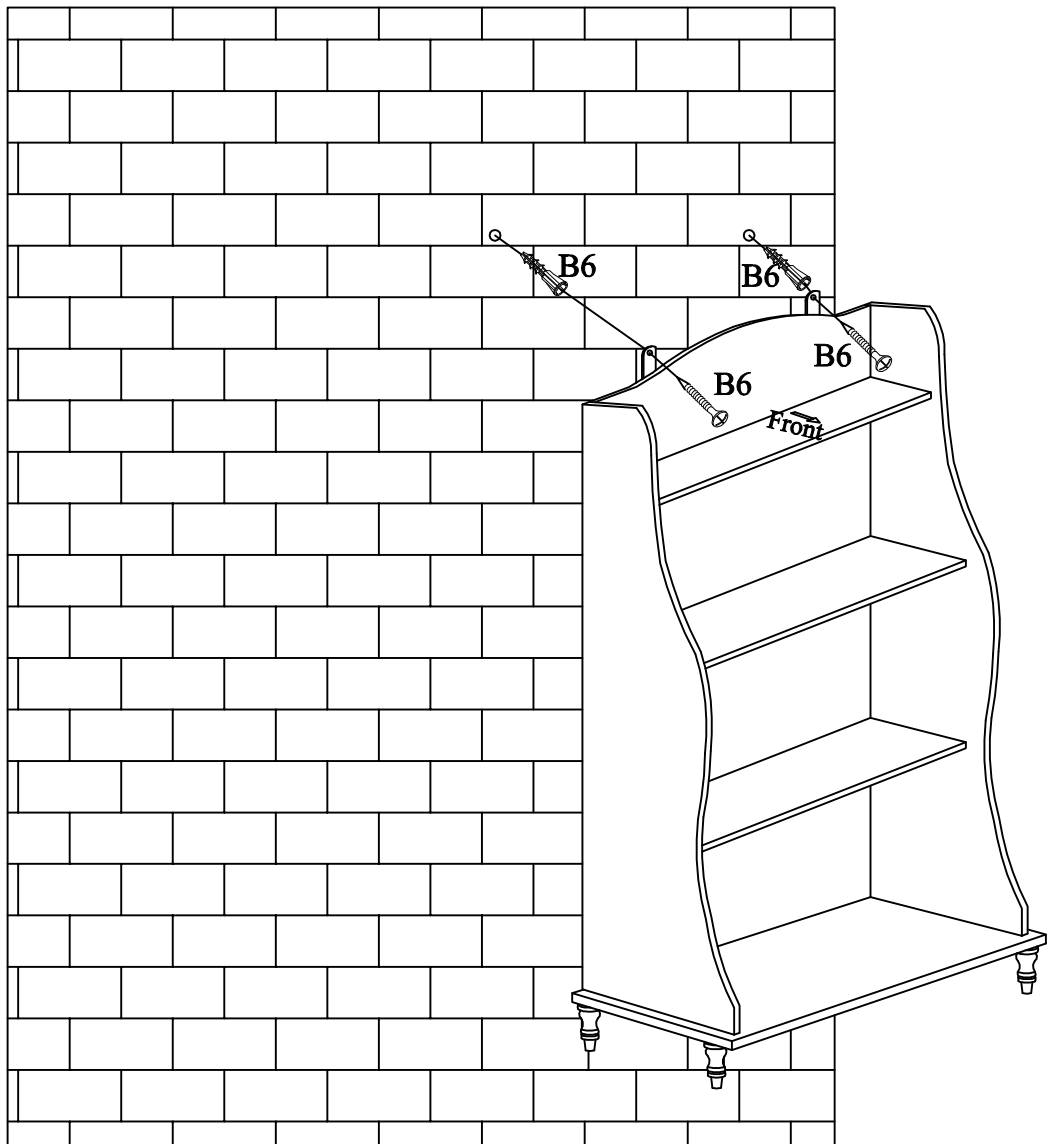

For safety purpose please kindly fix the tall bookcase to the wall using Anchors and Screws B6.

APPENDIX: Dimension of Hardwares in this AI.

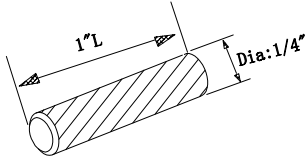
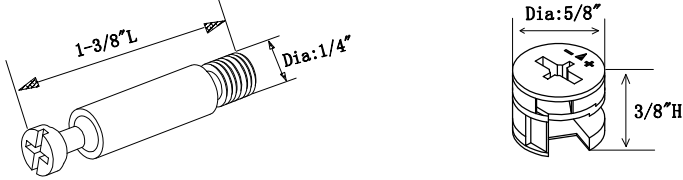
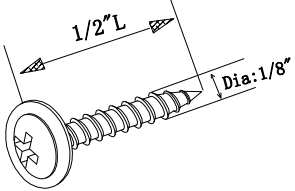
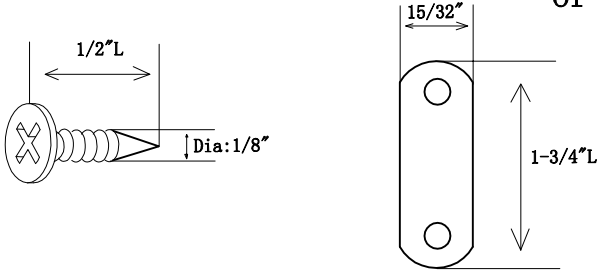
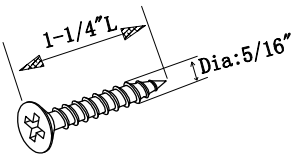
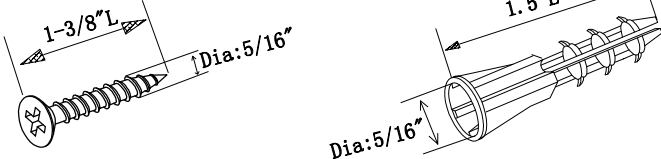
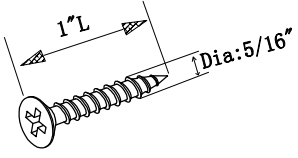
<p>B1. Quantity of 8</p>  <p>Wood Dowel</p>	<p>B2. Quantity of 14</p>  <p>Camlock</p>
<p>B3. Quantity of 24</p>  <p>Back Screw</p>	<p>B4. Quantity of 2</p>  <p>Metal plate and Screw</p>
<p>B5. Quantity of 4</p>  <p>Long Screw</p>	<p>B6. Quantity of 2</p>  <p>Screw and Anchor</p>
<p>B7. Quantity of 2</p>  <p>Short Screw</p>	