

ASSEMBLY INSTRUCTION

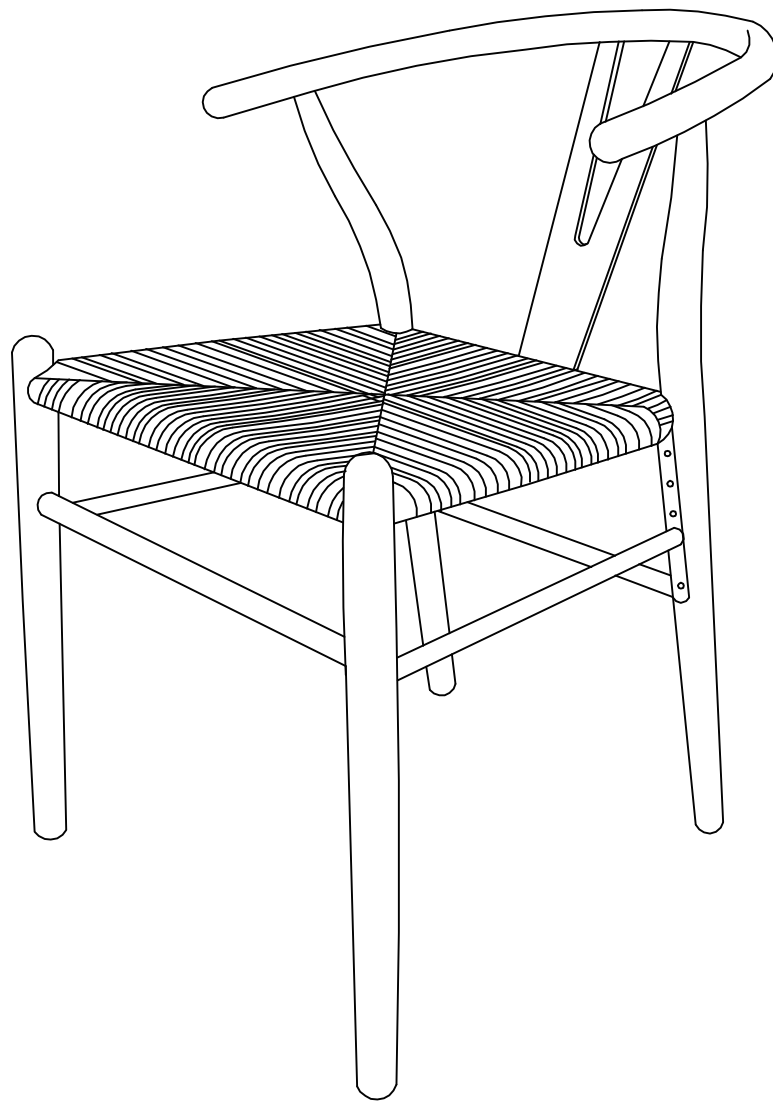

IMPORTANT NOTICE

INSTALLATION GUIDE

tools required: allen wrenches(provided)

ASSEMBLY REQUIREMENT

1. Remove all packaging materials, staples and packing straps from the carton.
2. Refer to Parts Checklist and ensure they are complete before you start assembling.





TIPS FOR ASSEMBLY

1. Allow ample room for assembly and in close proximity to where product will be placed.
2. Assemble the product on a surface that does not scratch or damage the exterior and finish of the furniture.
3. During assembly, do not over-tighten any fittings as this may cause damage.
4. Do not use power tools to assemble this product.
5. Do not sit or stand on the partially assembled product, use only installed products.

CARE AND USE

- Recommended for indoor and residential use only.
- Wipe with a soft, dry cloth. Do not use harsh abrasives or household cleaners as they may damage the finish.
- Check all the fittings periodically and re-tighten as necessary. Do not use the product if any of the parts is damaged or broken.

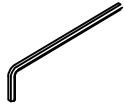
PARTS LIST

No.	Description	QTY	No.	Description	QTY
1		1	A		14
2		1	B		1
3		1	C		4

CAUTION: Please confirm the parts list before installtion

1

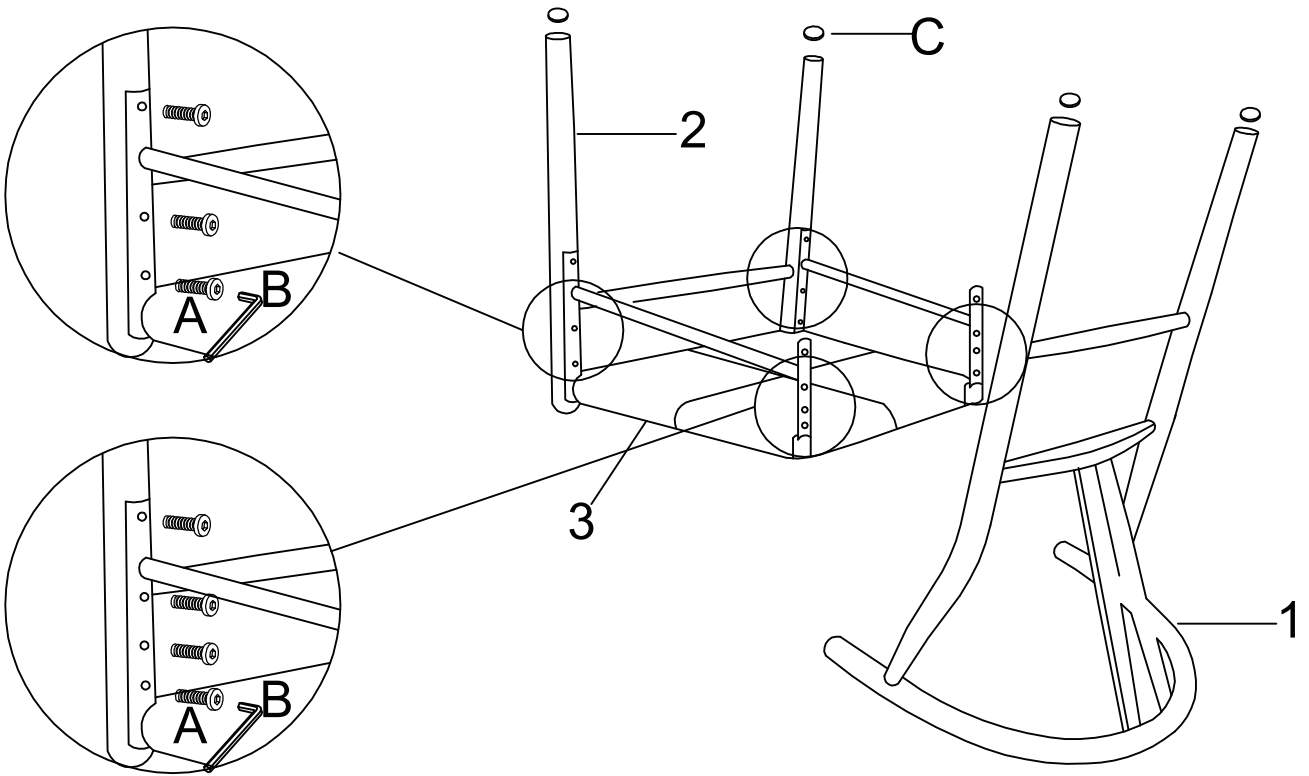

THANK YOU

Thank you for choosing our product. We sincerely hope that the assembly process has been smooth and enjoyable for you. If you have any questions or suggestions during the use of the product, please feel free to contact us.

